

THE CALIFORNIA EARTHQUAKE OF APRIL 18, 1906

REPORT

OF THE

STATE EARTHQUAKE INVESTIGATION COMMISSION

IN TWO VOLUMES AND ATLAS

VOLUME II

THE MECHANICS OF THE EARTHQUAKE

BY

HARRY FIELDING REID



WASHINGTON, D. C.

PUBLISHED BY THE CARNEGIE INSTITUTION OF WASHINGTON

1910

THE CALIFORNIA EARTHQUAKE OF APRIL 18, 1906

VOLUME II

THE MECHANICS OF THE EARTHQUAKE

STATE EARTHQUAKE INVESTIGATION COMMISSION

ANDREW C. LAWSON

G. K. GILBERT

H. F. REID

J. C. BRANNER

A. O. LEUSCHNER

GEORGE DAVIDSON

CHARLES BURCKHALTER

W. W. CAMPBELL

THE CALIFORNIA EARTHQUAKE OF APRIL 18, 1906

REPORT

OF THE

STATE EARTHQUAKE INVESTIGATION COMMISSION

IN TWO VOLUMES AND ATLAS

VOLUME II

THE MECHANICS OF THE EARTHQUAKE

BY

HARRY FIELDING REID



WASHINGTON, D. C.

PUBLISHED BY THE CARNEGIE INSTITUTION OF WASHINGTON

1910

D ET

CONTENTS.

PART I.

PHENOMENA OF THE MEGASEISMIC REGION.

	PAGE
THE TIME AND ORIGIN OF THE SHOCK	3-15
Descriptions of the Shock	3
The Beginning of the Shock	5
The Violent Shock	9
The Depth of the Focus	11
PERMANENT DISPLACEMENTS OF THE GROUND	16-28
The Results of the Surveys	16
The Nature of the Forces Acting	17
Illustrative Experiments	19
The Intensity of the Elastic Stresses	20
The Work Done by the Elastic Stresses	22
The Distribution of the Deforming Forces	22
The Distribution of the Slow Displacements	26
A Possible Origin of the Deforming Forces	27
ON MASS-MOVEMENTS IN TECTONIC EARTHQUAKES	29-32
The Movements before and during Earthquakes	29
The Prediction of Earthquakes	31
SHEARING MOVEMENTS IN THE FAULT-ZONE	33-38
Changes in the Length of Lines	33
Cracks in the Ground	34
Offsets of Fences and Pipes	35
Effects on other Structures	37
VIBRATORY MOVEMENTS AND THEIR EFFECTS	39-48
Character of the Movements	39
Cracks formed in the Ground and the Breaking of Pipes	40
Cracks in Walls and Chimneys	43
Rotatory Movements and the Rotation of Objects on their Supports	43
Surface Waves in the Megaseismic District	47
THE INFLUENCE OF THE FOUNDATION ON THE APPARENT INTENSITY	49-56
The Greater Damage on Alluvium	49
The Theory of Mr. Rogers's Experiments	49
Application of the Theory to Small Basins	53
Large Basins	54
The Foundation Coefficient	55

PART II.

INSTRUMENTAL RECORDS OF THE EARTHQUAKE.

COLLECTION AND REPRODUCTION OF THE SEISMOGRAMS	59
OBSERVATORIES AND THE DATA OBTAINED	60-108
Berkeley, California	62
Oakland, California	62

OBSERVATORIES AND THE DATA OBTAINED— <i>Continued</i>	PAGE
Yountville, California	62
Alameda, California	63
San Jose, California	63
Los Gatos, California	64
Mount Hamilton, California	64
Carson City, Nevada	65
Victoria, British Columbia	66
Sitka, Alaska	66
Tacubaya, Mexico	67
Cleveland, Ohio	68
Toronto, Canada	68
Honolulu, Hawaiian Islands	68
Ottawa, Canada	69
Washington, District of Columbia	69
Cheltenham, Maryland	70
Baltimore, Maryland	71
Albany, New York	71
Porto Rico (Vieques), West Indies	71
Trinidad, British West Indies	72
Apia, Samoa	72
Mizusawa, Japan	73
Ponta Delgada, Azores	73
Paisley, Scotland	73
Bergen, Norway	74
Eindburgh, Scotland	74
Tokyo, Japan	74
Bidston, England	75
Upsala, Sweden	75
Shide, Isle of Wight, England	76
Osaka, Japan	76
Kobe, Japan	77
Kew, England	77
Haniburg, Germany	78
Uccle, Belgium	78
Jurjew, Russia	78
Irkutsk, Siberia	79
Potsdam, Germany	81
Göttingen, Germany	81
Coimbra, Portugal	82
Leipzig, Germany	82
Jena, Germany	83
Strassburg, Germany	84
Moscow, Russia	84
Munich, Germany	85
San Fernando, Spain	85
Tortosa, Spain	86
Kremsmünster, Austria	86
Krakau, Austria	87
Granada, Spain	87
Pavia, Italy	88
Vienna, Austria	89
Salò (Brescia), Italy	89
Laibach, Austria	90
Triest, Austria	90
Budapest, Hungary	91

OBSERVATORIES AND THE DATA OBTAINED — <i>Continued</i>	PAGE
O'Gyalla, Hungary	91
Fiume, Hungary	92
Florence (Ximeniano), Italy	93
Zagreb (Agram), Hungary	93
Pola, Austria	94
Quarto-Castello (Florence), Italy	94
Zi-Ka-Wei, China	95
Pilar, Argentina	95
Urbino, Italy	95
Rocca di Papa, Italy	96
Belgrade, Servia	97
Carloforte, Sardinia, Italy	97
Sarajevo, Bosnia	97
Ischia, Italy	98
Caggiano (Salerno), Italy	99
Taihoku, Formosa, Japan	99
Sofia, Bulgaria	100
Messina, Sicily, Italy	100
Catania, Sicily, Italy	101
Rio de Janeiro, Brazil	101
Wellington, New Zealand	102
Calamate, Greece	102
Tifis, Caucasia, Russia	102
Taschkent, Russian Turkestan	102
Christchurch, New Zealand	103
Manila, Philippine Islands	103
Tadotsu, Japan	104
Cairo, Egypt	104
Calcutta, India	105
Bombay, India	105
Batavia, Java	106
Kodaikanal, Madras, India	106
Perth, Western Australia	106
Cape of Good Hope, Africa	107
Island of Mauritius	107
THE SEISMOGRAM AND ITS ELONGATION	109-114
Earlier Explanations	109
A New Explanation	110
The Stronger Transverse Waves	111
The Separation of the First Two Phases	111
The Direction of the Motion	112
The Principal Part and the Tail	113
THE PROPAGATION OF THE DISTURBANCE	115-134
The Hodographs	115
The Preliminary Tremors	117
The Paths of the Waves thru the Earth	121
Relation of the Velocity to the Depth below the Earth's Surface	122
Internal Reflections	123
The Surface Waves	125
Propagation along the Major Arc	127
Equality of Velocities along Different Paths	130
Comparison of the Hodographs of the California Earthquake with other Observations	130
Determination of the Distance of the Origin of an Earthquake	132

	PAGE
PERIODS AND AMPLITUDES	135-138
During the Preliminary Tremors	135
During the Long Waves and the Principal Part	136
In the Megaseismic District	136
Beyond the Megaseismic District	137
MAGNETOGRAPH RECORDS	139
CONCLUSIONS	140-142
Time	140
Undamped Instruments	140
Damped Instruments	141
Period of the Pendulum	141
Magnifying Power for Short Periods	141
Time-scale	142
Identification of the Phases on the Seismograms	142

APPENDIX.

THEORY OF THE SEISMOGRAPH.

INTRODUCTION	145
ROTATIONS DUE TO EARTH WAVES	145
FORMS OF SEISMOGRAPHS	147
REGISTRATION	148
THE MATHEMATICAL THEORY	148
THE HORIZONTAL PENDULUM	150
Determination of the Constants	157
Interpretation of the Record	166
Magnification of Harmonic Disturbances	172
Maximum Magnifying Power	175
Suspensions of Horizontal Pendulums	178
THE VERTICAL PENDULUM	179
THE INVERTED PENDULUM	183
SEISMOGRAPHS FOR VERTICAL MOVEMENTS	185
SEPARATION OF LINEAR DISPLACEMENTS AND TILTS	188
DEFINITIONS	191
USEFUL FORMULÆ	192

PLATES.

PLATE	FACING PAGE
1. Map showing Distances and Directions from the Origin of the Shock	59
2. Hodographs of the California Earthquake	114

PART I

PHENOMENA OF THE MEGASEISMIC REGION

THE CALIFORNIA EARTHQUAKE OF APRIL 18, 1906.

THE TIME AND ORIGIN OF THE SHOCK.

DESCRIPTIONS OF THE SHOCK.

The fact that the California earthquake of April 18, 1906, occurred a little after 5 A. M., before people in general were up, is one cause why we have so little reliable information regarding the exact time at which it occurred. In answer to questions sent out by the Earthquake Commission, a very large number of replies were received, but it is quite evident, from the variations among them and from the fact that many only gave the time to minutes, that these times are very unreliable. The general descriptions show that the earthquake began with a fairly strong movement which continued with increasing strength for an interval variously estimated, but which really amounted to about half a minute; then very violent shocks occurred, and quiet was restored about 3 minutes later.

Prof. George Davidson in Lafayette Park, San Francisco, marked time from the beginning of the shock, which he places at 5^h 12^m 00^s. He noticed hard shocks until 5^h 13^m 00^s, a slight decrease to 5^h 13^m 30^s, and quiet again about 5^h 14^m 30^s.¹

Prof. Alexander McAdie, in charge of the Weather Bureau office at San Francisco, wrote as follows to Professor Lawson under date of September 8, 1907:

I have looked up the record in my note-book made on April 18, 1906, while the earthquake was still perceptible. I find the entry "5^h 12^m" and after that "Severe lasted nearly 40 seconds." As I now remember it the portion "severe, etc.," was entered immediately after the shaking.

The time given is according to my watch. On Tuesday, April 17, 1908, my error was "1 minute slow" at noon by time-ball, or time signals which were received in Weather Bureau and with which my watch has been compared for a number of years. The rate of my watch was 5 seconds loss per day; therefore the corrected time of my entry is 5^h 13^m 05^s A. M. This of course is not the beginning of the quake. I would say perhaps that 6 or more seconds may have elapsed between the act of waking, realizing, and looking at the watch and making the entry. I remember distinctly getting the minute-hand's position, previous to the most violent portion of the shock. The end of the shock I did not get exactly, as I was watching the second-hand and the end came several seconds before I fully took in the fact that the motion had ceased. The second-hand was somewhere between 40 and 50 when I realized this. I lost the position of the second-hand because of difficulty in keeping my feet, somewhere around the 20-second mark.

I suppose I ought to say that for twenty years I have timed every earthquake I have felt, and have a record of the Charleston earthquake, made while the motion was still going on. My custom is to sleep with my watch open, note-book open at the date, and pencil ready — also a hand electric torch. These are laid out in regular order — torch, watch, book, and pencil.

Referring to the fact that his time is about a minute later than that given by other observers, he adds:

However, there is one uncertainty; I may have read my watch wrong. I have no reason to think I did; but I know from experiment such things are possible. * * * I have the original entries untouched since the time they were made.

¹ The time is given in Pacific standard time, 8 hours slow of Greenwich mean time.

Prof. A. O. Leuschner, director of the Students' Astronomical Observatory of the University of California, Berkeley, gives the following account of the shock as observed by his staff in the neighborhood of the Observatory:

The only reliable record of the commencement of the feeble motion was secured by Dr. S. Albrecht and given by him as 5^h 12^m 06^s, P. S. T. Dr. B. L. Newkirk, on the other hand, was the only observer who took pains to note the last sensible motion, for which he gives 5^h 13^m 11^s. The total duration resulting from these observations is 65 seconds. This is possibly not more than 5 seconds in error.

According to my own observations, the earthquake consisted of two main portions. They are based on counting seconds while carrying my small children out of the house. The earthquake came suddenly and gradually worked up to a maximum, which ceased more abruptly than it commenced. This [first part] lasted for about 40 seconds and was followed by a comparative lull, which was estimated at about 10 seconds. The vibrations then continued with renewed vigor, reaching a greater intensity than before and subsiding after about 25 seconds. According to these estimates the total duration of the disturbance was 75 seconds. It is, however, safe to assume that I counted seconds too rapidly in the excitement of the moment and this duration may easily be 10 seconds too long. The total duration of the sensible motion at Berkeley was probably close to 65 seconds. Dr. Albrecht reports that while he observed several severe shocks, the strongest occurred about 30 to 40 seconds after the beginning.

The mean time clock of the Observatory stopt at 5^h 13^m 39^s, P. S. T.

Prof. T. J. J. See, in charge of the Naval Observatory on Mare Island, San Pablo Bay, reports:

I had been sleeping downstairs, lying with head to an open window, which faced the south, and as the house was not seriously endangered at any time I was favorably situated for making careful observations of the entire disturbance. I had been awake some time before the earthquake began and, as everything was very quiet, easily felt and immediately recognized the beginning of the preliminary tremors. It consisted in an excessively slight movement of the ground, which I compared to the gentle rustling of a leaf in a quiet forest; and then the tremors grew steadily, but somewhat slowly, becoming gradually stronger and stronger, until the powerful shocks began, which became so violent as to excite alarm. Their duration was unexpectedly long, about 40 seconds, according to estimate made at the time, and the subsiding tremors then began. It was just light and I could see the clock face, and I noticed that at the beginning the corrected reading was about 5^h 11^m, and at the end about 5^h 14^m 30^s, so that the total duration of the disturbance including the faint tremors was about 3 minutes 30 seconds. The preliminary tremors occupied a little over a minute, the violent shocks about 40 seconds, and the final tremors about a minute and a half.

The exact time of the phenomenon. — This was found by the stopping of two of the four astronomical clocks at the Observatory. The violent shocks were so extreme that the pendulums were thrown over the ledges which carry the index for registering the amplitude of the swing. The standard mean time thus automatically recorded was: by the mean time transmitter, 5^h 12^m 37^s; by the sidereal clock, 5^h 12^m 35^s. The yard clock at the gate, which is simply an office clock, though electrically corrected from the Observatory daily, and therefore approximately correct, gave the time as 5^h 12^m 33^s. The agreement of all these clocks is very good; but I think the best time is the mean of the two astronomical clocks, viz.: 5^h 12^m 36^s. I estimate that the error of this time will not exceed about 1 second. It must be remembered that the preliminary tremors before the violent shocks began would tend to derange the motions of the pendulums, and they might separate, tho the effect would probably be slight, because the tremors were not violent. It is probable that both pendulums were hung up at the first powerful shock, but as one clock is sidereal and the other mean time, there is no assurance or even probability that the pendulums would be in the same relative position at the time of the arrival of the wave which gave the powerful shock. If the pendulums were not in the same relative parts of their beats, the chances are that one would be hung fast at least a second before the other. Now it was observed that the pendulum of the mean time clock was hung fast on the west side of its arc of oscillation, while the pendulum of the sidereal clock was hung fast on the east side. Both pendulums swing in the plane of the prime vertical. The difference in the time shown by the two clocks

is probably due therefore to slight derangements by the preliminary shocks, and to the instantaneous positions of the pendulums, which enabled one to be hung fast a second or more before the other; but I think the mean time here adopted is likely to be correct within 1 second.

Mr. J. D. Maddrill, in charge of seismographs and earthquake reports at Lick Observatory, Mount Hamilton, reports the beginning of the shock there, as the result of several observations, as 5^h 12^m 12^s. Mr. R. G. Aitken timed the heavy shock at 5^h 12^m 45^s, which corresponds exactly with the starting of the Ewing three-component seismograph.

On comparing these accounts, we notice that Professor See alone, probably on account of his unusually favorable situation, observed a very slight movement between 5^h 11^m and 5^h 12^m, and soon afterwards the violent shocks began, which correspond to the beginning noticed by Professor Davidson, Professor McAdie, Dr. Albrecht, and the Lick observers; this part of the disturbance was very strong, tho much lighter than the very violent shocks which occurred later. We shall refer to it as the *beginning of the shock*, looking upon the earlier, extremely slight movement observed by Professor See as a preliminary movement. Dr. Albrecht reports the heaviest shock at 30 or 40 seconds after the beginning; Mr. Aitken is corroborated by the starting of the seismograph at Lick Observatory in putting the heavy shock at 5^h 12^m 45^s, *i.e.*, 33 seconds after the beginning; and the most reliable clocks that were stopt agree in indicating a similar interval between the beginning and the shock that stopt them. As pointed out by Prof. C. F. Marvin,¹ the evidence is convincing that the clocks in general were stopt by the *violent shock*, which occurred about a half minute after the *beginning*, and was alone strong enough to affect seismographs at distant observatories.

THE BEGINNING OF THE SHOCK.

The majority of the reports as to the time of the beginning of the shock are only roughly approximate, but we fortunately have four very reliable observations, all of which are given by astronomers, who are accustomed to accurate estimates of small intervals of time.

First, San Francisco: Prof. George Davidson gives the time as 5^h 12^m 00^s \pm 2 seconds, Pacific Standard Time, which is 8 hours slow of Greenwich Mean Time. Mr. Van Ordine, who had a stop-watch, gives the time as 5^h 12^m 10^s; his watch was set two days before the earthquake and his time is not so reliable as that of Professor Davidson. Professor McAdie's time may be looked upon as confirming Professor Davidson's; all the reliable observations, as well as the reliable stopt clocks, make it absolutely certain that the shock began about 5^h 12^m and we must assume that Professor McAdie, suddenly awakened by a strong earthquake, made an error in reading the minute-hand of his watch, an error which is very easy to make; or that he applied the approximate correction and wrote down the corrected time. We shall accept Professor Davidson's time as the most accurate obtainable for San Francisco.

Second, Students' Observatory, Berkeley: Dr. S. Albrecht, 5^h 12^m 06^s.

Third, Lick Observatory, Mount Hamilton: The result of the observations of several astronomers, 5^h 12^m 12^s.

Fourth, International Latitude Station, Ukiah: Prof. S. M. Townley, 5^h 12^m 17^s. Professor Townley had been at work very late the previous night and was sleeping soundly when he was awakened by the earthquake. He immediately arose and went to the window and took the time of his watch, which when corrected became 5^h 12^m 32^s. Professor Townley estimates that 10 seconds may have elapsed from his first awakening and his reading of the watch, and that it may have taken 5 seconds for the disturbances

¹ Professor Marvin's Preliminary Report to the Commission on the Stopt Clocks has been drawn upon freely in this discussion.

to awaken him, and therefore that the time of the arrival was $5^{\text{h}} 12^{\text{m}} 17^{\text{s}}$. This time is far less accurate than the others but is certainly not more than a few seconds wrong and is important in estimating the origin of the shock on account of the location of Ukiah with respect to the other stations. This will be readily seen on referring to map No. 23 and to fig. 1, in which the long vertical line represents the fault, and the positions of stations with respect to it are shown.

There are, then, only four observations which should be taken into account in estimating the position of the centrum, which, we may assume, lies somewhere in the apparently vertical plane of the fault. The question arises whether the slip took place at various parts of the fault simultaneously, or, whether it occurred first over a limited area, and the stress, being relieved here, increased at other places, and thus the rupture spread along the fault, in both directions, at a rate probably somewhat less than that of the propagation of elastic waves of compression. In the first case the movement would have been propagated at right angles to the fault, and would have arrived at the various stations after intervals of time proportional to their distances from the fault-line. Taking our origin of time at $5^{\text{h}} 12^{\text{m}} 00^{\text{s}}$ we have the following data (where the t 's are the times of arrival after $5^{\text{h}} 12^{\text{m}} 00^{\text{s}}$, and the d 's are the distances from the fault-line): San Francisco, $t_1 = 0$ seconds, $d_1 = 12$ km.; Berkeley, $t_2 = 6$, $d_2 = 29$; Mount Hamilton, $t_3 = 12$, $d_3 = 33.7$, Ukiah, $t_4 = 17$, $d_4 = 42.6$. (These distances are determined from the maps and are not taken from fig. 1, where the fault is represented as perfectly straight.)

If we attempt from these data to determine the most probable value of the velocity and of the time of occurrence by the method of least squares, we find a velocity of 1.8 km./sec. and a time of $5^{\text{h}} 11^{\text{m}} 52.5^{\text{s}}$, with errors of -0.9 , $+2.5$, -0.8 , -1.0 seconds for the stations in the order given above; the sum of the squares of the errors is 8.6; the positive sign indicates that the observed times were too early, and *vice versa*. The small velocity calculated is quite inadmissible; and we therefore try the other alternative to see if it does not yield better results. We may consider that we have four unknown quantities to be determined: the time of the shock, the distance of the centrum measured along the fault-line from a given point of reference, its depth below the surface, and the rate of propagation. Four observations are sufficient to determine these four quantities, but the observations we have lead to impossible results, which may be seen by a general comparison of the positions of the stations and the times observed at them. For evidently there is no point on

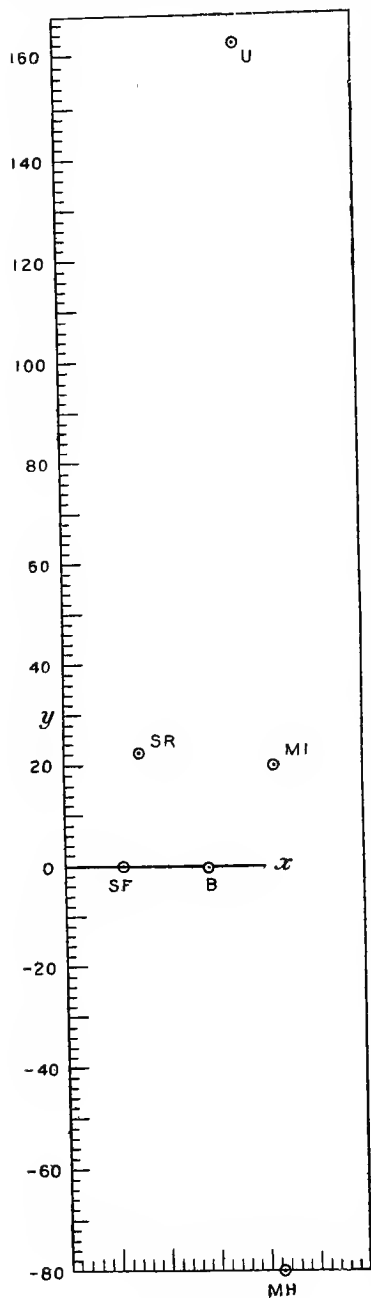

FIG. 1.

	x (km.)	y (km.)
Ukiah	36.1 . . .	161.8
San Rafael	15.2 . . .	22.2
Mare Island	42.15 . . .	20.5
San Francisco	11.7 . . .	0.0
Berkeley	28.85 . . .	0.4
Mount Hamilton	42.7 . . .	80.2

the fault-line so situated that the difference of the distances from it of Berkeley and San Francisco is half the difference of the distances from it of Mount Hamilton and

San Francisco, and one-third the difference of the distances of Ukiah and San Francisco; which shows that the observations are not accurate enough to make an exact determination of the unknown quantities possible. We are led therefore to assume a rate of propagation, and by trial to find the place on the fault-plane which will accord best with the observations; that is, which will make the sum of the squares of the errors least. In the neighborhood of an earthquake origin, the preliminary tremors, the second phase, and the long waves (which will be described further on) are not separately distinguishable; and there are very few and unsatisfactory observations regarding the rate at which the disturbance is propagated.

Professor Imamura ¹ calculates the velocity as 7.5 km./sec. from observations at Tokyo of earthquakes originating at an average distance of 679 km., the greatest distance being less than 1,300 km. Corresponding observations at Osaka give a velocity of 7.9 km./sec. for an average distance of 792 km., but they are rendered unreliable on account of the poor clock at that station. By the difference method, that is, by dividing the difference of the distance from the origin of two stations by the difference of time of arrival at them, he finds an average velocity of 12.1 km./sec., the stations ranging in distance between 284 and 1,285 km. from the origin. From observations at Tokyo and Mizusawa he finds by a similar method an average velocity of 9.6 km./sec. for an average distance of 522 km. from the origin, and 12.4 km./sec. for an average of 984 km.

Professor Omori ² finds for the velocity of two earthquakes between Taichu, near their origin in Formosa, and Tokyo, a distance of 1,620 km., 6.13 km./sec. and 6.75 km./sec., respectively. Tokyo is 1,710 km. from the origin and Taichu 90 km. In the first case the time at Taichu was determined by a chronometer watch, in the second from the seismogram; in both cases the Tokyo time was determined from the seismograms.

Professor Credner ³ finds by the difference in time of arrival at Leipzig and Göttingen of two small earthquakes whose origins were about 100 km. south of Leipzig, a velocity of 5.9 km./sec. Göttingen is about 200 km. from the origin.

Professor Rizzo ⁴ from observations of the Calabrian earthquake of 1905 at two stations, Messina and Catania, distant 84 and 174 km., respectively, from the epicentrum, finds a surface velocity of 6.9 km./sec.; this supposes the centrum at the surface; a deeper centrum would give a slightly smaller velocity. The tendency is always to obtain too low a value for the velocity. The strongest disturbance does not usually occur at the very beginning of the shock, but somewhat later; the earlier and lighter part is felt near the origin, but at a distance only the stronger part is observed; this is also true of seismograph records. The velocities calculated from such observations are evidently too small.

Professor Wiechert in a communication to the International Seismological Association in September, 1907, accepted 7.2 km./sec. as a fair value of the velocity near the surface of the earth; which is the same as the velocity near the origin. I have taken this value, 7.2 km./sec., as being probably as near the truth as we can come at present. With this velocity we find by the method of least squares that the most probable position of the centrum is at a point lying about 10 km. north of the point on the fault-line opposite San Francisco, and at a depth of 20 km. below the surface; the time of occurrence of the shock is 5^h 11^m 57.6^s; and the errors in seconds are: San Francisco, +1.1; Berkeley, -3.4; Mount Hamilton, -0.2; Ukiah, +2.4; the sum of the squares of the errors is 18.6 seconds. The objection to this determination is the error at Berkeley which is

¹ Publications of the Earthquake Investigation Commission in Foreign Languages, No. 18, p. 102.

² Note on the Transit Velocity of the Formosan Earthquakes of April 14, 1906. Bull. Imperial Earthquake Investigation Commission, vol. 1, No. 2, p. 73.

³ Die Vogtländische Erdbebenschwarm von 13 Feb. bis zum 18 Mai, 1903. Abh. math.-phys. Kl. K. Sächs. Gesells. d. Wissen. 1904, Bd. xxviii, p. 153.

⁴ Sulla Velocità di Propagazione delli Ondi Sismiche nel Terremoto della Calabria. Accad. R. delli Scienze di Torino, 1905-1906, p. 312.

apparently too large. The 15 seconds which Professor Townley allowed for the interval between the arrival of the shock at Ukiah and the moment that he read his watch seems to me rather long; if we reduce this interval to 12 seconds and take the time of arrival at Ukiah at $5^{\text{h}} 12^{\text{m}} 20^{\text{s}}$, the observations become more accordant; we find that the best position for the origin has the same geographical position mentioned above, but the centrum is near the surface, and the time of the shock becomes $5^{\text{h}} 11^{\text{m}} 59^{\text{s}}$; the errors of observations are: San Francisco, + 1.1; Berkeley, - 2.8; Mount Hamilton, + 0.9; Ukiah, + 0.7. The sum of squares of the error is 10.4 seconds. But the position of the centrum can not be looked upon as being determined very accurately; even if we put its depth at 30 km. we find the sum of the squares of the errors only 10.8 seconds; and the individual errors are: San Francisco, + 1.9; Berkeley, - 2.6; Mount Hamilton, + 0.6; Ukiah, + 0.2. This is a better group of errors, as that of Mount Hamilton is very small. The time is $5^{\text{h}} 11^{\text{m}} 57.7^{\text{s}}$.

It will be noticed that the groups of errors seem slightly to favor the idea of a simultaneous slip along the fault-line in preference to the slip beginning over a small area and then gradually spreading along the line. But let us notice what this really involves. In the first place it requires a velocity of propagation of only 1.8 km./sec., a value less than a quarter as great as the most probable value of this velocity.¹ It may be urged that these times refer to the arrival of the large surface waves, whose velocity has been determined as about 3.3 km./sec.; but with this value of the velocity we find much larger errors, the sum of the squares amounting to 36.9; and the separate consideration of the errors alone renders this supposition less probable than either of the other two; and, moreover, the preliminary tremors and large waves are not separated at such short distances from the origin as San Francisco and Berkeley.

Secondly, it is clear from the surveys of Messrs. Hayford and Baldwin (vol. 1, pp. 114-145) and from the discussion of them (pp. 16-28) that the rupture along the fault-line was the result of gradually increasing forces which finally became greater than the strength of the rock; before rupture the rock yielded elastically to the forces and it seems absolutely impossible that its ultimate strength, varying locally, should have been reached simultaneously over the whole area of the fault-plane, whose length was 435 km., or indeed over any large area. It would require a nice adjustment of the forces concerned, which the nature of the forces in no way leads us to expect. It is only in the case of absolute rigidity, which is far from the true nature of rock, that we can conceive of a simultaneous movement along the whole fault; and then we should be at a loss to account for the dying out of the fault at its ends. Moreover, our general experience is entirely against simultaneous yielding; when structures, such as bridges, break, they give way first at a particular point; when an ice-jam in a river yields, one part yields before the rest; and, indeed, many such examples might be cited. We are therefore constrained to believe that the rupture on the fault-plane began over a small area and rapidly spread to other parts of the fault.

We may then consider the position of the origin as determined within, perhaps, 30 km. along the fault-line and within 20 km. in depth; and the time, within 3 seconds; and we may write for

$$\text{The beginning of the shock } \left\{ \begin{array}{l} t_0 = 13^{\text{h}} 11^{\text{m}} 58^{\text{s}} \pm 3 \text{ seconds G. M. T.}, \\ \lambda = 121^{\circ} 36' \text{ W. } \pm 16', \\ \phi = 37^{\circ} 49' \text{ N. } \pm 12', \\ z_0 = 10 \text{ km. } + 20 \text{ km. or } - 10 \text{ km.}, \end{array} \right.$$

where t_0 is the time of the occurrence of the shock; λ , the longitude, and ϕ , the latitude,

¹ If we had taken the Ukiah time as $5^{\text{h}} 12^{\text{m}} 20^{\text{s}}$, the hypothesis of simultaneous slip would have required a velocity of 1.6 km./sec., and the sum of the squares of the errors would have been 17.4.

of the epicentrum; and z_0 , the depth of the centrum. The point lies exactly opposite the Golden Gate.

If, instead of a velocity of 7.2 km./sec. we had used 6.5 or 8, the position and time of the shock would not have been altered beyond the limits of error indicated above. A smaller velocity would have led to a deeper centrum and earlier time; a greater velocity would have had the opposite effect.

THE VIOLENT SHOCK.

The violent shock is the most important part of the earthquake, both on account of its destructive effects and because it alone could have affected distant seismographs. Indeed, Victoria is the only distant station where the first motion was recorded and it is the nearest seismographic station beyond the limits of sensible motion. Its distance was 1,156 km. from the origin and the disturbance was perceptible to a distance of 550 km. A large number of clocks were stopt by the strong motion; and one would naturally look to them to get the exact time of its occurrence. Professor Marvin has collected together all information regarding these clocks. For the great majority the time of the stopping is only known to minutes, and even then the differences between the various clocks are so great as to make the resulting average of very little value; it is therefore not necessary to give here the times recorded by all of them. We fortunately have observations from four stations which seem to be very reliable.

First, San Rafael: Two standard clocks were stopt; one the standard clock of the Time Inspector of the North Shore Railroad, stopt at $5^{\text{h}} 12^{\text{m}} 35^{\text{s}}$; the other, belonging to the night operator of the Railroad, stopt at $5^{\text{h}} 12^{\text{m}} 30^{\text{s}}$. Also a clock, belonging to the Western Union Telegraph Company, which sends out the time, stopt, the time being $5^{\text{h}} 13^{\text{m}}$; as the seconds are not given it is probable that they were not observed. This time must, therefore, be neglected; it is manifestly too late. The first two clocks are supposed to be very accurate and to be checked every day at noon. The average of their time is $5^{\text{h}} 12^{\text{m}} 32.5^{\text{s}}$.

Second, Mare Island: Two of the astronomical clocks, under the charge of Prof. T. J. J. See, stopt respectively at $5^{\text{h}} 12^{\text{m}} 35^{\text{s}}$ and $5^{\text{h}} 12^{\text{m}} 37^{\text{s}}$. A third clock which is electrically corrected every day, but is not a standard clock, stopt at $5^{\text{h}} 12^{\text{m}} 33^{\text{s}}$. Professor See thinks the best time is the average of the two astronomical clocks, namely, $5^{\text{h}} 12^{\text{m}} 36^{\text{s}}$.

Third, Berkeley: The astronomical clock at the Students' Observatory, under the charge of Prof. A. O. Leuschner, stopt at $5^{\text{h}} 12^{\text{m}} 39^{\text{s}}$.

Fourth, Mount Hamilton: The only clock that stopt was a small one in the Director's office, the correction for which was not accurately known; it stopt at $5^{\text{h}} 12^{\text{m}} 52^{\text{s}}$; we can not put any reliance on the exact time it gives. The shock began at Mount Hamilton at $5^{\text{h}} 12^{\text{m}} 12^{\text{s}}$, but the strong shock occurred at $5^{\text{h}} 12^{\text{m}} 45^{\text{s}}$. This is attested by the observation of Mr. Aitken and also by the fact that the Ewing seismograph was set in motion at that time. This seems the most accurate record we have of the time of the arrival of the heavy shock at a station near the origin.

The sidereal clock at the Chabot Observatory, Oakland, stopt at mean time $5^{\text{h}} 12^{\text{m}} 51^{\text{s}}$. The mean time clock stopt at $5^{\text{h}} 14^{\text{m}} 48^{\text{s}}$. Professor Marvin, however, has pointed out that the delicate gravity escapement of the latter might easily be thrown out of adjustment by the disturbance and thus allow the clock to race. It is evident that we can not take into consideration the time given by it. The sidereal clock, stopping 14 seconds later than the clock at Berkeley, may perhaps have been stopt, restarted, and stopt again by the shock. At any rate it is certainly too late and must be neglected. One clock at Ukiah may have been stopt and restarted; it was going after the shock,

but had been retarded by 6 seconds in time. Two of the astronomical clocks at Mare Island continued going after the shock, but they lost 20 seconds, which Professor See ascribed to "the rubbing of the pendulum points against the index ledges, which was also clearly shown by the brightening of the metal of the indexes." Altho this friction must have acted, it hardly seems sufficient to account for so large a loss in the minute or so of the strong shocks, and it is not unlikely that these clocks were stopt and started again. Some clocks must have been stopt at very nearly the correct time of the arrival of the shock, but it is impossible to distinguish them from other clocks, whose times are claimed to be correct, but which were evidently wrong; it is best, therefore, only to use times from the first four observations mentioned, which have been chosen because they can be relied on as very nearly correct.

The clocks which stopt evidently too late, and those which continued going but with the loss of some seconds of time, call attention to an error which may be made if we accept the time of a stopt clock as determining the time of the heavy shock. Let us notice in the first place that it is scarcely possible for the time thus determined to be too early; for, if the pendulum is made to vibrate too rapidly for a beat or two before it is stopt, the time is advanced; and if the pendulum is stopt, started, and stopt again, the clock will mark too late a time. It is only in case the gentler motion preceding the heavy shock should cause the pendulums to vibrate too slowly, that the stopt clock would indicate too early a time; but this gentler motion is just as apt to make the pendulums vibrate too fast. The difference between the time of the heavy shock at Mount Hamilton, which does not depend upon a stopt clock, and the times recorded by the stopt clocks at San Rafael, Mare Island, and Berkeley, make it evident that the latter could not indicate a time materially too late, unless we assume a rate of propagation of the disturbance much too low to be permissible. It is extremely probable, however, that the clocks did indicate a time slightly too late, and I have therefore taken for the times of arrival of the heavy shock at Mare Island and Berkeley one second earlier than the clocks indicated; these clocks were all astronomical clocks, and, with their known corrections, were practically correct just before the shock. The clocks at San Rafael were not astronomical clocks and may have been a little too fast; we can take 5^h 12^m 32^s, a half second earlier than their average, as the time of the shock at that place. The time at Mount Hamilton requires no modification.

We have therefore for the times, after 5^h 12^m 30^s, of arrival of the heavy shock and the distances of the stations from the fault-line: San Rafael, $t_1 = 2$ seconds, $d_1 = 16$ km.; Mare Island, $t_2 = 5$, $d_2 = 42$; Berkeley, $t_3 = 8$, $d_3 = 29$; Mount Hamilton, $t_4 = 15$, $d_4 = 33.7$. A glance at these data show that the shock was not simultaneous along the fault-line, for Berkeley and Mount Hamilton, less distant from the fault-line than Mare Island, felt the shock later. The times, with the positions of the stations as shown in fig. 1, indicate that the strong shock originated in a limited area somewhere to the northwest of San Rafael.

If, as in the case of the *beginning of the shock*, we use these four observations to determine our four unknown quantities, we find an imaginary value for the depth of the centrum, showing that the observations are not perfectly accurate. We may then, as before, assume various positions for the centrum and find by the method of least squares what time of occurrence and what velocity of propagation will make the sum of the squares of the errors least. The following table shows the results of these determinations; y_0 is the distance from a point on the fault-line opposite San Francisco to the origin, measured towards the northwest; z_0 is the depth of the centrum below the surface; t_0 , the time of occurrence, in seconds after 5^h 12^m 30^s; v , the velocity of propagation in kilometers per second; and Δ^2 , the sum of the squares of the errors in seconds between the calculated and observed times. It is to be noticed that the velocity is too high except in one case.

TABLE 1.—*Times, Velocities, and Errors for Various Positions of the Focus.*

y_0 .	z_0 .	t_0 .	v .	Δ^2
20	0	31.0	7.7	5.0
20	20	29.8	7.2	10.2
40	0	30.1	8.3	4.9
40	20	28.9	8.7	5.9
50	20	29.2	8.8	5.3

If now we assume a velocity of 7.2 km./sec., and repeat the calculations determining only t_0 , we get the following results for various positions of the centrum :

TABLE 2.—*Times and Errors for Various Positions of the Focus.*

y_0 .	z_0 .	t_0 .	Δ^2 .	y_0 .	z_0 .	t_0 .	Δ^2 .
20	0	30.5	9.3	50	0	27.8	7.6
20	20	29.8	10.2	50	20	27.4	7.7
30	0	29.8	8.9	60	0	26.7	8.3
30	20	29.2	7.2	60	20	26.2	7.6
40	0	28.9	6.7	60	40	25.1	6.7
40	10	28.8	6.9	100	0	21.9	16.6
40	20	28.4	6.6	100	20	21.6	16.0

There is not a very great difference in the sums of the squares of the errors for values of y_0 varying between 20 km. and 60 km., but they increase at both of these extreme distances (errors of a few tenths are insignificant as they are partially due to approximations in the calculations); and the times of course become earlier as the origin is placed further northwest. We may therefore adopt for the approximate position of the centrum of the violent shock, $y_0 = 40$ km. \pm 20 km., $z_0 = 20$ km. \pm 20 km., and for the time of occurrence, $t_0 = 5^{\text{h}} 12^{\text{m}} 28^{\text{s}} \pm 2$ seconds. The individual errors of the times of observation become at San Rafael, Mare Island, Berkeley, and Mount Hamilton, respectively, + 0.6 second, + 0.4, - 2.1, + 1.3. If in these calculations we had used a velocity of 6 km./sec. or 8 km./sec., our results would not have been altered beyond the uncertainty indicated. We may therefore write for

$$\text{The violent shock } \begin{cases} t_0 = 13^{\text{h}} 12^{\text{m}} 28^{\text{s}} \pm 2 \text{ seconds G. M. T.}, \\ \lambda = 122^{\circ} 48' \text{ W. } \pm 5', \\ \phi = 38^{\circ} 03' \text{ N. } \pm 4', \\ z_0 = 20 \text{ km. } \pm 20 \text{ km.} \end{cases}$$

The point lies between Olema and the southern end of Tomales Bay. This position of the point of beginning of the *violent shock* receives some confirmation by the fact that the violence of the shock was probably as great in this neighborhood as anywhere, and that the displacements along this part of the fault-line were the greatest recorded.

THE DEPTH OF THE FOCUS.

There are two ways of determining the depth of the focus: by observations of the times of arrival of the shock at various stations and by a consideration of the distribution of the damage and other effects produced by the disturbance over the surface of the earth. The two methods do not determine identically the same point. The time method gives the location and depth of the point where the shock started, whereas the method depending upon the distribution of intensity gives the depth of the whole of the fault-plane.

First: a glance at fig. 2, where f represents the focus of the shock, will show very clearly that the distance from the focus to the various stations depends upon its depth, and if we

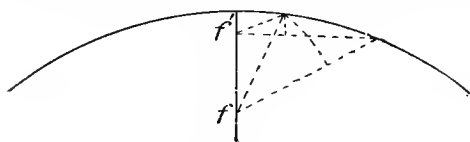

FIG. 2.

knew the exact time of the shock, the time of the arrival at the stations and the velocity of propagation, we could immediately calculate the depth of the focus. As a matter of fact we do not know the exact time of the shock, nor do we know the exact velocity, but by observations at a number of stations all these quantities could be determined, provided the observations were sufficiently accurate. Here, however, is where the difficulty lies. The table on page 119, which gives the time of the arrival of a disturbance according to the distance of the station from the epicenter and the depth of the focus, shows that this time is very slightly affected by the depth of the focus when the distances are as great as three or four times this depth; and therefore to get from time observations an even fairly approximate value of the depth we must have a number of stations very close to the epicenter, and the observations must be extremely accurate — to within a second or so. Neither of these conditions have been satisfactorily fulfilled heretofore, and determinations of the depth of the focus based on this method are unreliable. In the case of the California earthquake the observations at the four stations considered are probably more favorable, both as to the situations of the stations and the accuracy of the observations, than has been realized at any former earthquake; but nevertheless it has been shown that they are not sufficiently accurate to determine the various unknown quantities in the problem, and they merely indicate that the depth at which the violent shock originated is probably not more than 40 km. The variation of this method by the use of Seebeck's or Schmidt's hodographs can not yield more reliable results; and its application when the time of arrival, not of the beginning of the shock, but of a strong reinforcement of the motion, is used is by no means to be recommended; for in this case we can not say that the special part of the disturbance observed has traveled directly thru the body of the earth; and the whole theory of the method depends upon this supposition. In some cases it is quite evident that the time of arrival of the long waves has been used, and these waves are supposed to be propagated along the surface.¹

Second: the distance of points from the focus will increase more slowly with their distance from the epicenter for deep than for shallow foci, and therefore the intensity of the action at the surface will diminish more slowly. Maj. C. E. Dutton has shown that if we consider the extent of the origin small and the damage done by the shock at the surface proportional to the energy of the motion there, the change in the amount of damage will be most rapid at a distance from the epicenter of about 1.7 times the depth of the focus; and this distance is independent of the actual intensity of the shock.²

If we attempt to apply this method to the California earthquake, we meet with many difficulties. The disturbance was by no means confined to a small area, but was spread, more or less unevenly, over the whole fault-plane. It probably did not take place simultaneously, but varied in time at different parts of the fault. If it had occurred simultaneously, the method might be applied by adding up the effects due to the different parts of the fault, but if the movement occurred even at slightly different times in different parts of the fault, their effects at some points would be successive and at some points simultaneous. The general averaging of these results might, however, enable us to form a rough

¹ See for example Faidiga; "Das Erdbeben vom Sinj am 2 Juli, 1898," Mitt. Erdb.-Com., K. Akad. Wiss. Wien, No. xvii, 1903. The time of arrival of the second preliminary tremors would be a better time to use than that of the first preliminary tremors; for they travel only about two-thirds as fast, and therefore the differences in their times of arrival would be somewhat greater at two stations of slightly different distances from the centrum.

² The Charleston Earthquake of August 31, 1886. 9th Ann. Rep. U. S. Geol. Surv., 1887-1888, pp. 313-317.

estimate of the depth if we were not confronted by another difficulty, namely the variations of the effects due to the character of the foundation. These variations, as shown on the general map, No. 23, and on the intensity map of the city of San Francisco, No. 19, are so great that it is quite impossible to obtain accurate values for the depth of the fault all along its course; but opposite Point Arena the isoseismals are sufficiently regular to throw some light on the subject. In attempting to solve this problem, we must make a number of assumptions, which are by no means exactly true, but are nearly enough so to make our result of some value; they are: that the amount of energy sent out by each element of the fault-plane per unit time was the same; that the amount of energy sent out in any direction from each element was proportional to the cosine of the angle between that direction and the normal to the fault-plane; that the strong disturbance continued for a sufficient time all along the fault-plane to permit us to assume that points not very distant were receiving simultaneously the strong vibrations from a length of the fault-plane 8 or 10 times as great as their distances from it; and that the effective force at any point is proportional to the square root of the energy of the disturbance at that point.

With these assumptions we can determine the energy of the disturbance at any point not far from the fault by adding together the amounts of energy sent to that point by each element of the line.

The vibrational disturbances at the various points of the fault-plane do not unite to form a single wave-front, for the movements must be in different phases at different points, and both distortional and longitudinal vibrations in various directions are present; for this reason it might appear that the energy would be sent out uniformly in all directions and not according to the cosine law; but if we make this assumption, we find an infinite amount of energy near the fault, which is, of course, impossible, and we are therefore led to assume the cosine law, which is probably not very far wrong.¹

For a simple harmonic vibration of a given period the energy of the motion is proportional to the square of the amplitude, and the maximum acceleration to the amplitude itself, that is, to the square root of the energy. When we consider that, at every place where the disturbance was felt, the vibrations were in all directions and had various periods and amplitudes, we see that it is quite impossible to determine the true acceleration, but the square root of the energy will be roughly proportional to it. Professor Omori has shown that the effective force is proportional to the acceleration and has estimated the values of the various degrees of the Rossi-Forel Scale in terms of actual accelerations.²

In fig. 3 let P be the point on the earth's surface at which the disturbance is to be determined and x its perpendicular distance from the fault-plane, $O'Obb'$. Let b be any element of the fault-plane, whose depth below the surface is z and whose distance from O' , measured parallel to $O'b'$, is y . Then the energy of the disturbance at P is found by adding the amounts sent from all such elements of the fault-plane, remembering that the intensity

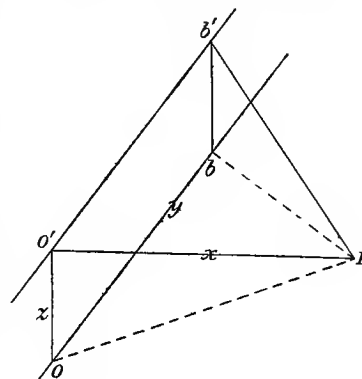

FIG. 3.

¹ It is also probable that the vibrations sent out from each point are regular only for a very short time. These considerations lead to the conclusion that no places on the earth's surface experience a low intensity of disturbance on account of the interference of vibrations; for altho the interference might exist at a particular moment, the irregularity of the motion would only allow it for a very short time; and the intensity ascribed to a particular place is the maximum intensity which is felt there at any part of the shock. On the other hand, it is quite possible for strong vibrations from two parts of the fault-plane to combine and cause unusual intensity along a particular line or zone. No definite instances of this, however, can be cited in the case of the California earthquake.

² Publications of the Earthquake Investigation Commission in Foreign Languages, No. 4.

dies down inversely as the square of the distance; the energy at P is, therefore, proportional to

$$\int_0^D dz \int_{-\infty}^{+\infty} \frac{xdy}{(x^2 + y^2 + z^2)^{\frac{3}{2}}} = 2 \tan^{-1} \frac{D}{x},$$

where D is the depth of the fault. The limits of the integral along the fault assume an infinite length for the fault; but the result is practically the same if the angle between two lines drawn from the ends of the fault to P is nearly 180° ; that is, if the distance of P from the fault is small compared with its length. The values of $\sqrt{\tan^{-1} \frac{D}{x}}$ have been plotted in fig. 4 in terms of $\frac{x}{D}$. It will be noticed it is a function of $\frac{x}{D}$ and is independent of the actual intensity of the disturbance at the fault-plane; but unlike Major Dutton's energy curves, there is no point of inflection in our curve (this is due

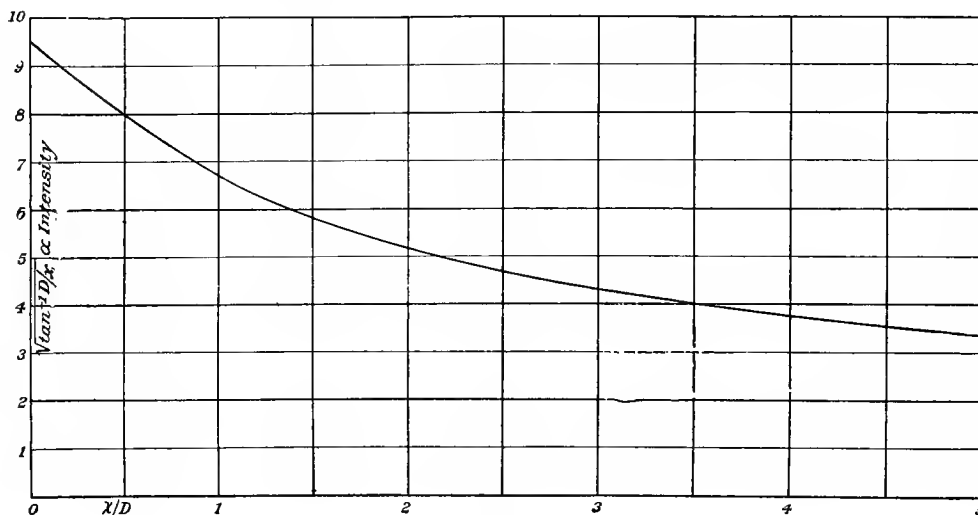

FIG. 4.

to the fact that the fault-plane is not confined to a considerable depth, but extends to the surface of the earth). We must therefore, to determine the depth of the fault, determine the distance of the point where the force bears some definite proportion to the force in the immediate neighborhood of the fault-plane, for instance, where it is half as great. We find from the curve that the distance of this point is about 2.5 times the depth of the fault. We must, now, from our map of intensities determine the actual distance from the fault-plane of the points where the force had diminished to half its value at the fault-line. Professor Omori¹ has estimated that the acceleration on the made ground in San Francisco was somewhat less than 2,500 millimeters per second per second, and therefore the acceleration on rock at the fault-plane may be taken at about this value. According to Professor Omori's scale, a force about half as great, or 1,200 millimeters per second per second, corresponds to the degree VIII of the Rossi-Forel Scale, and this isoseismal occurs at a distance of about 20 km. from the fault-line opposite Point Arena; 20 km. is therefore 2.5 times the depth of the fault, which accordingly becomes 8 km. We must not attach too much importance to this result; the assumptions and the data are all too inaccurate, but we can accept it as indicating that in the neighborhood of Point Arena the fault could hardly have extended to a greater depth than 20 km. and probably was not so deep. The distribution of isoseismals north of

¹ Bull. Imperial Earthquake Investigation Commission, vol. 1, No. 1, p. 19.

San Francisco Bay show that this conclusion is applicable to all that part of the fault; but further south the isoseismals, where not greatly affected by soft ground, lie close to the fault, indicating a smaller depth.

Both methods of determining the depth of the fault agree in indicating that it is comparatively shallow; the only considerations opposing this are: its length, its comparative straightness, its independence of the topography, which it seems to have controlled rather than to have followed, and the very considerable geologic time which has elapsed since movements were first inaugurated along the rift (vol. 1, pp. 48-52). All these facts undoubtedly suggest great depth, but our ignorance of the causes leading to the fault movements makes us attach greater weight to the more definite conclusions already arrived at, and to regard the movement of April 18, 1906, as comparatively shallow. It is the general belief of geologists that fractures of the rock are confined to a crust of small thickness; Professor Van Hise estimates that about 12 km. is the greatest depth to which they can reach, and he bases this estimate on the consideration that the weight of the overlying rock is sufficient at that depth to prevent the formation of cracks or crevices. He writes: "In rocks which were bent when so deeply buried that cracks or crevices could not form even temporarily, it is probable that the material flowed to its new position quietly, without shock, under the enormous stress to which it was subjected."¹ But this is not a sufficient criterion; rock can fracture by shearing without the formation of crevices just as a block can slide on a second one without separating from it; in the case of the California earthquake there is no necessity for believing that the two sides of the fault did not always remain in contact while they were slipping past each other, and, as is pointed out further on, the movement near the ends of the fault is taken up by elastic or plastic distortion.

The temperature increasing with the depth increases the plasticity of the rock, but the increasing pressure increases its rigidity to a greater extent, at least for forces like those due to elastic vibrations and the tides of short periods, which do not continue to act for a very long time in the same direction; but for long-continued forces in the same direction, provided they do not increase too rapidly in intensity, the plasticity probably allows slow deformation and prevents the forces from ever reaching the ultimate strength of the rock.

The question which must be answered to determine the depth to which fractures can occur is: At what depth does the plasticity of rock become sufficient to enable it to yield to the stress-difference, which may exist there, rapidly enough to prevent this stress-difference from reaching the ultimate strength of the rock? Unfortunately we do not know any of the elements of the problem, neither the plasticity of the rock as dependent on pressure and temperature, nor the rate at which stress-differences accumulate at distances below surface. It is probable that the point at which a fracture first occurs is not the lowest point to which it extends; for when the break comes, the forces are suddenly transferred to nearby points, and thus the fracture may be carried to depths where no fracture would take place otherwise.

There is very little observational evidence bearing on the question we are discussing. The Appalachian Mountains are characterized in Pennsylvania by open folds and few faults; as we follow the range to the southwest the folds become closer and the faults increase, and in Tennessee, North Carolina, Georgia, and Alabama, the faulting becomes excessive. Mr. Bailey Willis has pointed out² that the thickness of the sediments above the Cambro-Silurian limestone was about 23,000 feet (7,000 meters) in Pennsylvania, 10,000 feet (3,000 meters) in southwestern Virginia, and only 4,000 feet (1,200 meters) in Alabama; and he thinks the differences in folding and faulting are due to the differences of the loads when the deformations took place. This indicates that faults are very shallow.

¹ Principles of Pre-Cambrian Geology, 16th Ann. Rep. U. S. Geol. Surv., 1894-95, pp. 593-595.

² Mechanics of Appalachian Structure, 13th Ann. Rep. U. S. Geol. Surv., 1891-92, p. 269.

PERMANENT DISPLACEMENTS OF THE GROUNDS.

THE RESULTS OF THE SURVEYS.

Accurate surveys of a part of the region traversed by the fault-line of 1906 were made by the U. S. Coast and Geodetic Survey at various times. These have been grouped for the sake of discussion into three periods, namely: I, 1851-1865; II, 1874-1892; III, 1906-1907. These surveys, as discust by Messrs. Hayford and Baldwin (vol. 1, pp. 114-145), show that in the intervals between the surveys certain definite displacements of the land took place. They bring out especially well the displacements which took place in the region north of San Francisco and the Farallon Islands during the time between the II and III surveys, an interval which included the earthquake of 1906. The field observations and the surveys were complementary; the former determined the relative displacements at the fault-line, and the latter the displacements at a

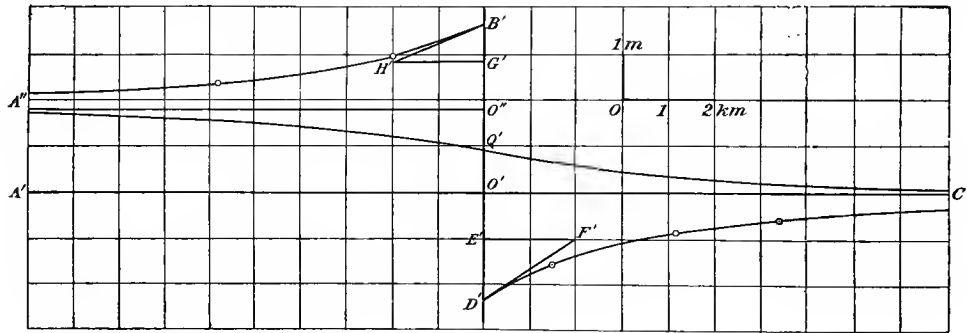

FIG. 5.

distance from it. The results of Messrs. Hayford and Baldwin may be express by fig. 5; they show that the displacements reached a maximum at the fault and were smaller as the distance from the fault was greater, in such a way, that a line which, at the time of the II survey, was straight, as $A'O'C'$, had, at the time of the III survey, been broken at the fault and curved into the form $A'B', D'C'$. And, altho at a few points there is an indication of a compression or an extension at right angles to the fault, generally the movement was parallel with it. The figure is drawn to scale from the summary on page 133 (vol. 1) and shows how the displacements diminish with the distance from the fault. The scale of displacements is 1,000 times that of distances; the curvature of the lines is so very small that it would be imperceptible if the two scales were the same.

The known length of the fault is about 435 km. (270 miles) and it is quite possible that it may be somewhat longer below the surface. Whatever may be its length, the fault terminates at some points beyond which no slip took place; the eastern side of the fault moved towards the southern region of rest and away from the northern region of rest; and the western side of the fault did just the opposite; there must have resulted near the northern end of the fault a compression of the land on the western side and an extension on the eastern; and near the southern end the extension must have been on

the western side and the compression on the eastern side. There may have been a more or less irregular distribution of compressions and extensions along the course of the fault due to differences in the amount of the movement, but these, according to Dr. Hayford, are slight except in the region just south of San Francisco. The question arises: How were these compressions and extensions taken up? Did the volume remain constant and the density change; or did the density remain constant and the volume change; or did both changes occur? We have not sufficient evidence to answer this question; but the general properties of matter would indicate that both changes occurred. To the north of San Francisco Bay there seems to have been, in places, a very slight elevation of the land west of the fault, and the only satisfactory explanation so far offered of the action of the tide-gage at Fort Point (described in vol. 1, pp. 367-371) indicates a small depression of the west side of the fault opposite the Golden Gate. It is not impossible, altho it is by no means clearly indicated, that the slight elevation of the western side along the northern part of the fault may be due to an increase in volume there, and that the probable depression opposite the Golden Gate may be due to a decrease in volume, which must have taken place in that region, on account of the smaller displacement just south of it.

Returning now to the curving of former straight lines at right angles to the fault as shown in fig. 5, the first analogy suggested by the lines is that of a bent beam. If a beam, which is long in proportion to its thickness, is supported at one end and a weight hung from the other, the beam bends into a curve very much like that shown in the figure; the under, concave surface is compressed; the upper, convex surface is stretched; and between the two there is a neutral plane which is neither compressed nor stretched. But when the thickness of the beam is great in comparison with its length, the distortion is due to the elastic shear of each layer over its neighbor. In this case the thickness of the beam would be 435 km. (270 miles) and the length probably less than one-twentieth as much; so that the distortion must have been due to shear and not to bending in the ordinary sense of the word.

THE NATURE OF THE FORCES ACTING.

We know that the displacements which took place near the fault-line occurred suddenly, and it is a matter of much interest to determine what was the origin of the forces which could act in this way. Gravity can not be invoked as the direct cause, for the movements were practically horizontal; the only other forces strong enough to bring about such sudden displacements are elastic forces. These forces could not have been brought into play suddenly and have set up an elastic distortion; but external forces must have produced an elastic strain in the region about the fault-line, and the stresses thus induced were the forces which caused the sudden displacements, or elastic rebounds, when the rupture occurred.¹ The only way in which the indicated strains could have been set up is by a relative displacement of the land on opposite sides of the fault and at some distance from it. This is shown by the northerly displacement of the Farallon Islands of 1.8 meters between the surveys of 1874-1892 and 1906-1907, but the surveys do not decide whether this displacement occurred suddenly at the time of the earthquake, or grew gradually in the interval between them; there are valid reasons, however, for accepting the latter alternative, as the following considerations show: The Farallon Islands are far beyond the limits of the elastic distortion revealed by the surveys, so that we can not ascribe their displacement to elastic rebound; and we have seen that this is the only kind of force which could have produced a sudden movement; and what

¹ We use the words *strain* and *stress* as they are used in the theory of elasticity. A *strain* is an elastic change of shape or of volume caused by external forces; and a *stress* is a resisting force which the body opposes to a strain, and with which it tends to diminish it.

is still more convincing, we shall shortly see that not only was the displacement of 1.8 meters of the Farallons between the survey of 1874-1892 and 1906-1907 insufficient to account for the slip on the fault, but the additional displacement of 1.4 meters which they experienced between the surveys of 1851-1865 and 1874-1892 leaves this quantity still too small.

We must therefore conclude that the strains were set up by a slow relative displacement of the land on opposite sides of the fault and practically parallel with it; and that these displacements extended to a considerable distance from the fault. Let us consider this process; suppose we start with an unstrained region, fig. 6, in which the line AOC is straight; suppose forces parallel to $B'D''$ to act on the regions on opposite sides of the line $B'D''$ so as to displace A and C to A'' and C'' ; the straight line AOC will be distorted

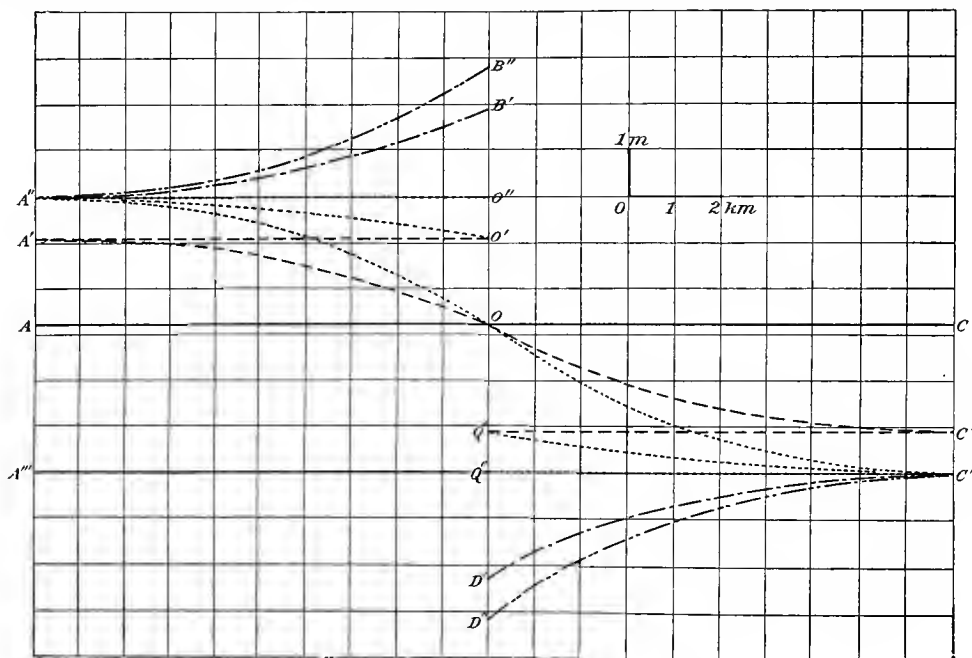

FIG. 6.

into the line $A''OC''$; if the distortion is beyond the strength of the rock, a rupture will occur along $B'D''$; the line $A''OC''$ will be broken and the two parts will become straight again and will take the positions $A''O''$ and $C''Q''$; and $O''Q''$ will represent the relative slip at the line of rupture, which will be equal to $A''A'''$, the sum of the opposite displacements which A and C gradually experienced when they were brought to A'' and C'' . All points on the western face of the fault will move a distance OO'' to the north, and all points on the eastern face a distance OQ'' to the south. The straight line which occupied the positions $A''O''$ and $C''Q''$ just before the rupture will be distorted to $A''B''$ and $C''D''$, these lines being exactly like $A''O$ and $C''O$, but turned in opposite directions. The sum of $O''B''$ and $Q''D''$ will exactly equal $O''Q''$, the total slip.

When we examine the actual displacements about the fault-line, we find that the slip $B'D'$, fig. 5, about 6 meters, is fully 4 meters greater than the relative displacement of A' and C' since the survey of 1874-1892; this means that the region was not unstrained at that time, but that A' and C' had already suffered a relative displacement of about 4 meters from their unstrained positions; that is, two-thirds of the stress which caused the rupture had already accumulated 25 years ago. Going still further back to the surveys of 1851-1865, we find that the total relative displacement of distant points on

opposite sides of the fault since that date amounts to about 3.2 meters, a little more than half enough to account for the slip on the fault-plane; therefore 50 years ago the elastic strain, which caused the rupture in 1906, had already accumulated to nearly half its final amount. It seems not improbable, therefore, that the strain was accumulating for 100 years, altho there is no satisfactory reason to suppose that it accumulated at a uniform rate.

We can picture to ourselves the displacements and the strains which the region has experienced as follows: let AOC (fig. 6) be a straight line at some early date when the region was unstrained. By 1874–1892, A had been moved to A' and C to C' , and AOC had been distorted into $A'OC'$; by the beginning of 1906, A had been further displaced to A'' and C to C'' , the sum of the distances AA'' and CC'' being about 6 meters; and AOC had been distorted into $A''OC''$. When the rupture came, the opposite sides of the fault slipped about 6 meters past each other; $A''O$ and $C''O$ straightened out to $A''O''$ and $C''Q''$; and the straight lines which occupied the positions $A''O''$ and $C''Q''$ just before the rupture, were distorted afterward into the lines $A''B''$ and $C''D''$, these lines being exactly like the lines $A''O$ and $C''O$ but turned in opposite directions. The straight lines, which occupied the positions $A'O'$ and $C'Q'$ in 1874–1892, were distorted into $A''O'$ and $C''Q'$ in the beginning of 1906; at the time of the rupture their extremities on the fault-line had the same movements as other points on that line; O' moved to B' and Q' to D' . If we should move the left half of our figure so as to make $A'O'$ continuous with $C'Q'$, fig. 6 would then be practically similar to fig. 5 and similar letters in the two figures would refer to the same points; in fig. 5, however, we have supposed C' to remain stationary and have attributed all the relative movement to A' , whereas in fig. 6 we have divided the movement equally between A' and C' ; as we do not know the actual, but only the relative, movement this difference has no significance.

What was actually determined by the two surveys were the distances of points on the line $C'D'$ and $A''B''$ in fig. 5 measured from the line $C'A'$; and this is equivalent in fig. 6 to the distances of the line $C''D''$ from $C''Q''$, and $A''B''$ from $Q''A''$ less the distance $O'Q'$. The divergence of the lines $A''B''$ and $C''D''$ from straight lines does not represent the strains which existed in the region just before the rupture, but only the strains accumulated before 1874–1892; we have seen that the total strains set up by 1906 are represented by the divergence from straight lines of the lines $A''O$ and $C''O$, or their counterparts, $A''B''$ and $C''D''$.

ILLUSTRATIVE EXPERIMENTS.

The following very simple experiments were made to illustrate the conclusions we have arrived at regarding the elastic strains and the relations between the slip at the fault-plane and the displacements of distant points. A sheet of stiff jelly about 2 cm. thick and 4 cm. wide was formed between two pieces of wood (fig. 7) to which it clung fairly well. A straight line AC was drawn on the jelly, which was then cut by a sharp knife along the line tt' ; the left piece of wood was then moved about 1 cm. parallel with tt' , as shown in fig. 8; a slight pressure on the jelly prevented slipping along the cut line; the jelly was thus subjected to an even shear thruout and the original straight line AC was distorted into the line $A''C$; when the pressure on the jelly was removed, the elastic stresses set up by the distortion came into action, the two sides of the jelly slipped past each other along the line tt' , $A''O$ straightened out to $A''O''$, and CO to CQ'' , the slip $Q''O''$ being equal to the distance AA'' ; and all the strain in the jelly was relieved. (The difference in the straight line $A''OC$ in the jelly and the curved line $A''OC''$ (fig. 6) in the rock will be explained later.)

A second straight line $A''O''C''$ was drawn across the jelly after A had been displaced, but before it was allowed to slip on the line tt' ; when the slip took place, this line broke

at O'' and took the position $A''B''$ and $C''D''$; the slip $D''B''$ equaled the displacement AA'' ; but the points A'' and C'' , of course, remained unmoved.

A third experiment was made. A line $A'C'$ (fig. 9) was drawn after the jelly had been distorted, exactly as in the last experiment; the left piece of wood was then moved 0.5 cm. further and the line was distorted into $A''C''$; when the jelly slipped and resumed

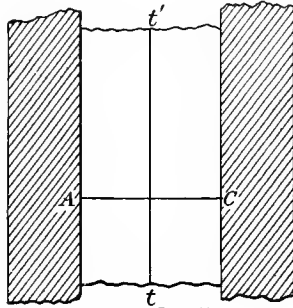

FIG. 7.

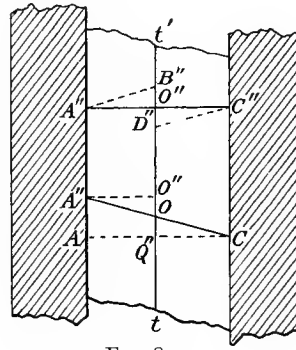

FIG. 8.

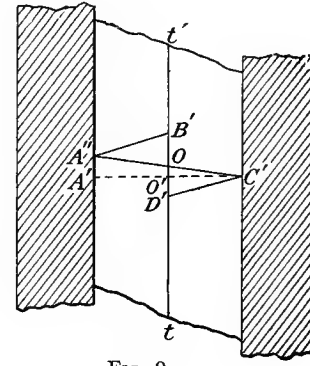

FIG. 9.

its unstrained position, the line $A''OC''$ broke into the two lines $A''B'$ and $C'D'$; the slip $D'B'$ was 1.5 cm., equal to the total displacement of the left piece of wood from its original position when the jelly was unstrained; and the distances of points on the line $A''B'$ near the fault, measured from the line $A'C'$, were about twice the distances from $A'C'$ of points on the line $C'D'$ at equal distances from t' . But at a distance from t' the displacements on the left were more than twice as great as those on the right; which agrees with the relative displacements actually observed (vol. I, p. 134). With the exception of the straightness of the lines the last experiment reproduces exactly the characteristic movements which took place at the time of the California earthquake. The letters in figs. 7, 8, and 9 correspond to those in figs. 5 and 6.

THE INTENSITY OF THE ELASTIC STRESSES.

The forces which caused the rupture at the fault-plane are measured by the distortion of the rock there, and if we can determine the angles which the lines $A''O$ and $C''O$ (fig. 6) make with AC at O , we can estimate these forces; these angles can be determined approximately from the analogous angles at B' and D' . Let us determine what the latter angles are. The lines $A''B'$ and $C''D'$ are constructed from Dr. Hayford's summary of the results of the surveys already mentioned and have the same curvature as the lines $A''B'$ and $C''D'$ in fig. 5; the data (vol. I, p. 133) may be collected in a table as follows:

TABLE 3. — Displacements between II and III Surveys.

No. of Points.	AVERAGE DISTANCE FROM FAULT.		DISPLACEMENT BETWEEN II AND III SURVEYS.	
	East.	West.	South.	North.
	<i>km.</i>	<i>km.</i>	<i>m.</i>	<i>m.</i>
10	1.5	1.54
3	4.2	0.86
1	6.4	0.58
12	...	2.0	2.95
7	...	5.8	2.38
1	...	37.0	1.78

It will be observed that three points are determined on the eastern line near enough to the fault to enable us to draw the line fairly well and to extend it to the fault at D' (fig. 5). We have but two points determined on the western line near the fault, which are not enough to determine the character of the line; but a third point is determined from the fact that B' must be about 6 meters from D' , and we can therefore draw the western line fairly well also. Its general form is like that of the eastern line, but its curvature is somewhat less. This is probably in part due to the fact that the rocks on the western side of the fault are more rigid than those on the eastern side; for former movements on this fault have raised the western side relatively to the eastern and brought the more rigid crystalline rocks nearer the surface.

In fig. 6 $B'B'' = O'O'' = 0.9$ meter, that is, half of 1.8 meters, the total relative displacement of A' and C' between the two surveys; and since $O''B''$ is a little less than half the total slip, on account of the greater rigidity of the western rocks, we may estimate it at 2.8 meters. Therefore $O''B'$ equals 1.9 meters, and $O''B''$ is 1.47 times $O''B'$; and since the curves $A''B'$ and $A'B''$ are both curves of elastic distortion of the same substance the angle at B'' must be 1.47 times that at B' .¹ We can measure the angles at B' in fig. 5 and we find it $1/2,500$; therefore the angle at B'' is $1/1,700$; similarly we find the angle at D'' to be $1/1,000$.

We can determine the force necessary to hold the two sides together before the rupture, which must exactly have equaled the stress which caused the break. The force per square centimeter is given by the expression ns where n is the coefficient of shear and s is the shear, measured by the angle at O or B'' for the western side of the fault, or the angle at O or D'' for the eastern side. We shall see further on that in the crystalline rocks below the surface the strain was somewhat greater than at the surface, so that we may assume that the angle corresponding to B'' lower down may be as high as $1/1,500$.

The experiments of Messrs. Adams and Coker² give the value of n for granite as 2×10^{11} dynes per square centimeter (2,900,000 pounds per square inch); therefore the force necessary to produce the estimated distortion at the fault-plane at a short distance below the surface is $1/1,500$ of this, or 1.33×10^8 dynes per square centimeter (1,930 pounds per square inch). There are no very satisfactory determinations of the strength of granite under pure shear; tests made at the Watertown Arsenal³ gave values ranging between about 1.2×10^{11} and 1.9×10^{11} dynes per square centimeter (between 1,700 and 2,900 pounds per square inch), but these values are apparently too small, for the specimens were subjected to tensions and compressions as well as to shear. The rock at a distance below the surface would probably have a greater resistance to shear on account of pressure upon it, and moreover it has not been subjected to the changes of temperature, etc., which the surface rocks experience, so that it probably has a strength greater than the higher figure given. We must therefore conclude that former ruptures of the fault-plane were by no means entirely healed, but that this plane was somewhat less strong than the surrounding rock and yielded to a smaller force than would have been necessary to break the solid rock. This idea is strongly supported by a comparison of the distance to which this shock and the earthquake of 1886, at Charleston, South Carolina, made themselves felt. With a fault-length of 435 km. (270 miles), the California earthquake was noticed at Winnemucca, Nevada, a distance of 550 km. (350 miles) at right angles to the fault; whereas the Charleston earthquake, with a fault-line certainly less than

¹ This reasoning is not perfectly rigid; the similarity of the lines $A''B'$ depends upon the similarity of strains set up during the intervals between the I and II, and the II and III surveys. These were probably fairly similar, as the difference between them represents the strain added between the II and III surveys which was only a fraction of the total strain at the time of the break; and the results obtained upon this assumption can not be very far wrong.

² An Investigation into the Elastic Constants of Rocks. Frank D. Adams and Ernest G. Coker, Carnegie Institution of Washington, Publication No. 46, 1906.

³ Report of Tests of Metals, etc., made at the Watertown Arsenal, 1890, 1894, 1895. Washington, D.C.

40 km. (25 miles) long was felt slightly in Boston, a distance of 1,350 km. (850 miles). If we assume that the vibrations from the two disturbances had about the same periods and that a certain acceleration is necessary for a shock to be felt, we find that the amplitude of the vibration must have been about the same at Boston and at Winnemucca, for the two shocks, respectively; as the amplitude would diminish inversely as the distance for the Charleston earthquake, but much more slowly for the California earthquake on account of the length of the fault-line, the amplitude of the former disturbance must have been many times as great as that of the latter at the same distance from the origin; and the intensity must have been very many times greater per unit area of the fault-plane for the Charleston earthquake than for the California earthquake.

The above calculation of stresses applies especially to the region north of San Francisco; to the south the slip at the fault-line was, in places and perhaps for all this part of the fault, somewhat smaller. At Wright the slip on the fault-plane in the tunnel is given by the engineers as 5 feet, and the west side was shifted toward the north (vol. I, fig. 42, and pp. 111-113). This is a case of elastic rebound as at other parts of the fault. The character of the material in the tunnel and the numerous cracks in the surrounding mountain, one of which shows a relative shift opposite to that generally observed (p. 35), lead us to expect more or less irregularity in the distortion of the tunnel, which is confirmed by the figure. The greatest angle of shear must be something more than half the slip at the fault-plane divided by the distance over which the distortion is distributed; this gives $2.5/5,150$ or $1/2,000$, approximately. The angle of distortion is apparently slightly less here than further north. The smaller slip in the neighborhood of Colma, a little south of San Francisco, may be due to the partial relief of strain by the earthquake of 1868; for it shows that this region was under less strain at the time of the II survey than the region further north.

THE WORK DONE BY THE ELASTIC STRESSES.

We can also determine the work done at the time of the rupture; it is given by the product of the force per unit area of the fault-plane multiplied by the area of the plane and by half the slip. If we take the depth of the fault at 20 km. (12.5 miles), the length at 435 km. (270 miles), the average shift at 4 meters (13 feet), and the force at 1×10^8 dynes per square centimeter (1,450 pounds per square inch), we find for the work 1.75×10^{24} ergs (1.3×10^{17} foot-pounds), or 130,000,000,000,000,000 foot-pounds.¹ This energy was stored up in the rock as potential energy of elastic strain immediately before the rupture; when the rupture occurred, it was transformed into the kinetic energy of the moving mass, into heat and into energy of vibrations; the first was soon changed into the other two. When we consider the enormous amount of potential energy suddenly set free, we are not surprised, that, in spite of the large quantity of heat which must have been developed on the fault-plane, an amount was transformed into elastic vibrations large enough to accomplish the great damage resulting from the earthquake and to shake the whole world so that seismographs, almost at the antipodes, recorded the shock.

THE DISTRIBUTION OF THE DEFORMING FORCES.

In examining what forces could have caused the slow displacements which brought about the strains existing in the region before the rupture, we note that gravity does not seem to have been directly active, as the displacements were practically horizontal. Any force except gravity could only have been applied to a boundary of the region

¹ It is probable that the maximum strain was not produced at all parts of the fault-plane, and especially not near its ends; but when the rocks broke at one place, the stress was thrown upon adjacent parts and the fracture thus carried along; in this way the fault was probably made much longer than it would otherwise have been. This consideration leads us to put the maximum stress at three-quarters the value determined from the distortion of the rock.

moved. There is no direct evidence that forces brought into play by the general compression of the earth thru cooling or otherwise were involved, for there is no evidence that the surface of the earth was diminished by the fault. It is true that the surveys did not extend over the whole length of the fault, and therefore are not decisive on this point, but so far as they went they show an extension of the region between San Francisco and Monterey Bay, between the surveys of 1851-1865 and 1906-1907.

A strong, shearing force would be produced along the fault-plane by forces making an angle in the neighborhood of 45° with it; that is, by either tensions or compressions in directions roughly north and south or east and west, or by a combination of the two. A tension alone could not have caused the rupture, for then the sides would have been pulled apart; an east-west compression would have brought Mount Diablo and the Farallon Islands nearer together and would have reversed the observed relative movements on opposite sides of the fault. The surveys, altho not entirely decisive, are against a north-south compression; and, moreover, the elastic distortion accompanying a compression which could produce a fracture 435 km. long would not have been restricted to a zone extending only 6 or 8 km. from the fault-plane. A shear exerted by forces parallel with the fault-plane on the eastern and western boundaries (which is equivalent to a north-south compression and an east-west tension at the boundaries) with no resistance at the under surface would have produced an even shearing strain thruout the region between them; and straight lines would have been changed into other straight lines, exactly as occurred in the experiments described above and illustrated in figs. 8 and 9. An additional compression or tension in any direction would not have altered this characteristic. Similar forces on the eastern and western boundaries with forces at the under surface resisting the movements would have produced some such distortion of the straight line AC into $A'C'$ as shown in fig. 10. The tendency to rupture would be greatest at A' and C' and least in the neighborhood of O ; it is evident that such forces could not have produced a rupture at O , and the displacements are not like the displacements observed.

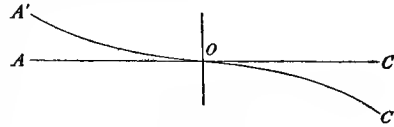

FIG. 10.

The only other boundary is the under surface of the moved region, and it is here that we must suppose the disturbing forces applied; and they must be distributed over this surface so as to produce the distortions observed.

NOTE. — Mr. Gilbert has suggested a modification of the experiments described above; instead of making the cut, which represents the fault, all the way thru the jelly, he suggested that it extend only a part way thru, and that it would thus more nearly represent the true conditions of the earthquake fault. This was tried, but the jelly was not strong enough to resist the forces developed during the displacement and the break was quickly extended all the way thru the jelly. It is not difficult, however, to see what forces would be developed under these circumstances. There are two cases: first, suppose there exists below the crust a region practically devoid of elasticity, in which only viscous forces can act, and suppose the fault extends to this region; we then come back to the last case considered. Second, suppose the elastic character of the rock extends well below the lower limit of the fault; such a case could easily exist if the strength of the rock increased with depth, even tho the strains continued far below the fault as great as they were within its limits. Let us consider the nature of the distortion produced in this case. We shall suppose the rock under elastic shearing strain, and when the rupture occurs, the shearing forces across the fault-plane, which upheld the strain, are annulled and the rock takes a new position of equilibrium under the new forces brought into action, in such a way that the surface line $A'OC'$ (fig. 11), straight just before the rupture, afterwards takes the position $A'O', D'C'$. Below the limit of the fault no change takes place, but the original vertical plane thru $A'O'C'$ has been broken and warped, suffering no displacement below the fault, but gradually increasing its distortion until it corresponds to AO' and $D'C'$ at the surface.

An element of the surface a , on the eastern side of the fault, has been displaced to a' and a vertical line, $a''a$, thru a has been distorted into $a''a'$ by an elastic shear. The forces parallel with the fault acting on the element in its new position are: a shearing force to the south-east on its northeastern face, one to the north-west on its southwestern face, one to the north-west on its under surface due to the shear in the vertical plane; for equilibrium the sum of these must be zero, therefore the shearing force on the northeastern face must be greater than that on the southwestern; this relation holds for the whole length of the line $D'C'$; the shearing stresses therefore must become greater as we leave the fault-line. As the strains are proportional to the stresses, the curvature of the line $D'C'$ must become greater

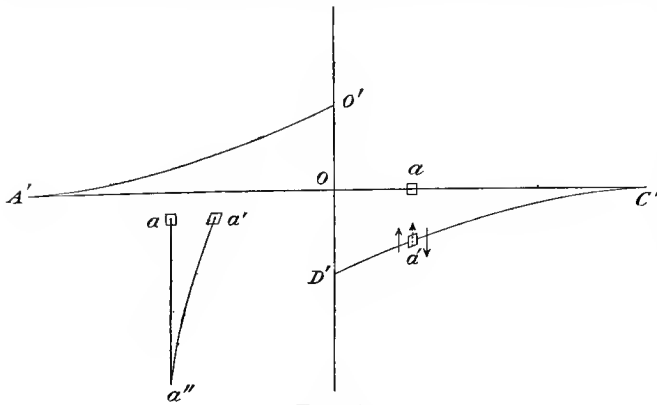

FIG. 11.

the further we go from the fault, until we reach the boundary where the forces are applied. This is true whether the forces are tangential forces applied along a boundary parallel with the fault, or a general north-south compression and an east-west tension. The surveys, however, on the east side of the fault, where alone they are sufficiently complete, show that the curvature of the distorted line was greatest near the fault-line; they could not, therefore, be due to a general compression and extension nor to simple tangential forces, but the distorting forces must diminish with distance from the fault-line; this could only hold if they were applied at the under surface, which brings us back to the conclusion already reached.

Let us suppose the straight line WOE in fig. 12 to represent a line at right angles to the fault in the unstrained condition; let this line be slowly distorted by the applied forces into the full line $WAOCE$ just before the rupture. We have heretofore only considered the region between A and C , that is, between Mount Diablo and the Farallon Islands, but we now extend our consideration to the whole region moved. It is evident that the displaced

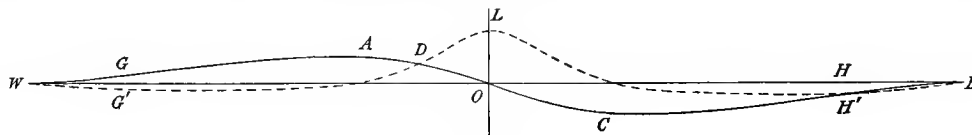

FIG. 12.

area must have some limit; the surveys only covered the region between A and C , and therefore throw no light on what occurred at greater distances from the fault. There is no reason whatever to believe that other ruptures and slips occurred outside the region between A and C ; there is a gradual diminution of the intensity of the felt disturbance as the distance from the fault increases, with the exception of the Sacramento Valley, where the slight increase is entirely accounted for by the alluvial character of the ground, thus indicating that the whole disturbance originated in the one fault. The great intensity in the San Joaquin Valley may possibly be due to a local rupture; but this lies only opposite to the southern part of the great fault and does not affect the general argument, which is especially applicable to the region north of San Francisco. We conclude therefore that the displacement gradually dies out to the west of A and to the east of C , tho it may continue for a very great distance; and we assume that the line of displacement becomes asymptotic to the undisturbed line WOE at some distant points, W and E , which would be characteristic of any displacement gradually dying out. The shearing force at any point of this line is proportional to the shear, which equals the angle at that

point which the line makes with its original unstrained direction. We have represented the value of this force by the broken line $WG' LH'E$ in fig. 12. Starting at W where it is zero, the shearing force becomes negative; that is, it is directed in a southerly direction, reaching a negative maximum at G' , where the displacement curve has a point of inflection; it then diminishes in value, becoming zero at A , where the displacement curve is parallel with its original direction; it then increases rapidly in value, reaching a positive maximum, L , at O , the point of rupture; the shearing force to the east of the rupture has somewhat the same value it has at an equal distance to the west, tho symmetry is not required. The total shearing force which we have determined is not the force applied at each point under consideration, but is equal to the sum of all the forces applied to the east or west of the point; the actual force applied at each unit length of the line is proportional to the difference in value of the total shearing force at points a unit distance apart; that is, to the angle which the line representing the total shearing force makes with the line WOE ; it is represented by $WGDOFH E$ in fig. 13. Starting with a zero value at W , it first has a small negative value but becomes zero again at G ; it then becomes positive and increases to a maximum at D , where the line of total shear has a point of inflection—and dies down rapidly to zero at O , where the total shear is a maximum; it has somewhat similar but opposite values to the east of O .

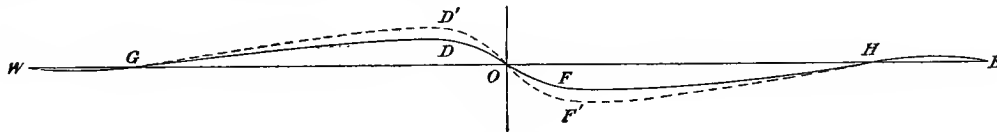

FIG. 13.

Without insisting on accuracy in small details the full line in fig. 13 shows in a general way the relative distribution of the forces, applied at the under side of the moved region, which brought about the California earthquake.

The distribution of the total shearing forces shows why in 1906 there was no break at the Haywards fault, where the break occurred which caused the earthquake of 1868. This fault is about 30 km. (18.5 miles) east of the San Andreas fault; and therefore in the neighborhood of C (fig. 12), where the surveys detected no displacement relative to Mount Diablo; in this region, as the figure shows, there was practically no shearing force, and therefore no break occurred. For the same reason there was no rupture at the San Bruno fault south of San Francisco. This fault is 4 km. (2.5 miles) east of the San Andreas fault and at that distance (fig. 5) the shearing force was only about one-third as strong as it was where the rupture actually occurred. We have seen that the elastic strain was probably accumulating for 100 years; it is quite possible, then, that the earthquake of 1868 partially relieved the strain for some distance south of San Francisco and that there would have been no fracture in this part of the San Andreas fault if additional strains had not been thrown on it by the rupture of the fault-plane further north.

It is to be noticed that the distances from O to A and from O to C , beyond which no distortion of the rocks occurred, were probably less than 10 km. (6 miles), and the distances OG and OH , over which the distorting forces were distributed, were probably ten or more times as great, and the total area over which they were applied was many times as great as the area of the fault-surface; the applied forces were therefore considerably smaller per unit area than the shearing forces at the fault; for the sum of all these forces on each side of the fault-plane must have equaled the shearing force at that plane plus the small shearing force at G or H , due to the slight reverse curving at this point.

As the dragging forces are applied at the base of the crust they have a moment about its center of gravity which is balanced by the moment due to stronger and greater shears near the bottom than near the top at the points G , O , and H (fig. 12); and lines at differ-

ent distances below the surface which were straight and at right angles to the fault when the rock was unstrained became distorted in different degrees, the distortion from the surface downwards being somewhat as shown in fig. 14, where the three lines illustrate,

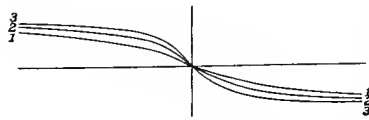

FIG. 14.

in an exaggerated way, how the distortion of straight lines varies from the surface (1) to the bottom (3). Both the shearing strain and the strength of the rock increase with the depth, but the rate of neither is known; the depth at which the rupture first occurs is the depth at which the shearing strain becomes too great for the rock to withstand. It is pretty certain that this would not be very near the surface, and also that it would not be at the lowest part of the subsequent fault, but somewhere between those two points; for, wherever the rupture began, the strain must have been increased on all sides, the fracture must have been extended downwards as well as in other directions, until the strain was generally relieved. The determination, by time observations, of the origins of the earliest disturbance and of the beginning of the heavy shock place them between the surface and a depth of 40 km. (25 miles).

THE DISTRIBUTION OF THE SLOW DISPLACEMENTS.

We have no information regarding the absolute displacements of the land at a distance from the fault-line; we merely know that relative displacements occurred between the surveys of 1851-1865 and 1874-1892; and also between 1874-1892 and 1906-1907. We have for the sake of simplicity assumed that the regions at a distance from the fault and

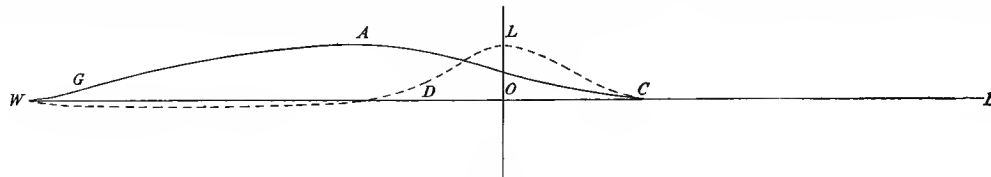

FIG. 15.

on opposite sides experienced nearly equal and opposite absolute displacements; but this is entirely unnecessary. It is possible, indeed probable, that the region on one side of the fault and at a short distance from it remained stationary, and that the slow displacements were all in one direction. The fact that the eastern side was above, and the western side below the sea-level, does not in the least indicate which side remained stationary; but the constancy in length and direction of the line from Mount Diablo to Mocho suggests that the eastern side was not displaced; for it seems improbable that, if this side had moved,

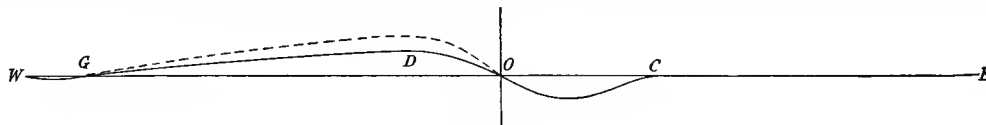

FIG. 16.

the displacements would have been so nearly alike at the points mentioned that no change could be detected in the line joining them. Under this assumption our curve of displacements takes the form of the full line in fig. 15 instead of that in fig. 12. The curvature of this line between A and C is the same as in the former case; to the east of C the line is straight, and at some point to the west of A it again reaches its unstrained position. The total shearing force (represented by the broken line in fig. 15) has practically the same values as in the former case, except that it dies out near C; and the applied forces per unit area (full line in fig. 16) do not differ materially from the former case except that they do not extend farther east than C.

A POSSIBLE ORIGIN OF THE DEFORMING FORCES.

The reasoning so far has been strictly along dynamic lines and the results may be accepted with some confidence; but in attempting to find the origin of the forces which produced the deformation we have been studying, we pass into the region of speculation.

The theory of isostasy, which has been shown to be true on broad lines by geodetic observations, requires that there be flows of the material at some distance below the surface to readjust the equilibrium destroyed by the erosion and transportation of material at the surface. This suggests that flows below the surface may have been the origin of the forces we have been considering, for as Dr. Hayford has pointed out,¹ such flows would exert a drag on the material above them. The isostatic flows are the direct result of gravity and therefore easily understood, but no explanation has been found for the flows suggested as the origin of the forces in the case under consideration; nevertheless, as the forces must have been exerted at the lower surface of the moved region, it is worth while to determine the character of the flows which could have produced these forces, and leave to future observations the decision as to whether they really exist or not. Without assuming exact proportionality between the flow and the dragging force it exerts, we can say that the flow would be in the same directions as the force and would increase and decrease with it. Therefore the flow can be inferred from the diagram of forces in figs. 13 and 16. In the first case they consist of a flow to the north between G and O , and a flow to the south between O and H ; they would not be uniform, but starting with a zero value at G and H , they would increase to maxima at D' and F' , and decrease again to zero at O . The force between W and G , H and E , would not be due to flows but would be due to the resistance to the displacement of that part of the crust by the undisturbed material below; this displacement being due to the drag of the flows nearer the fault, transmitted elastically thru the crust to these regions; this is indicated by the reversed curvature of the line of displacements in fig. 12. The principle of continuity would naturally lead us to suppose that the flows were connected beyond the northern and southern ends of the fault; these portions of the flow would be so far apart and would have so short a length in comparison with the portions flowing north or south that their effects would be relatively insignificant. It may appear that there is a suggestion here of perpetual motion, but this is not so; all steady flows are in closed circuits, and it is only in case we should disregard the necessity of a proper supply of energy, that we should fall into the fallacy of perpetual motion.

The line of demarkation between the northerly and southerly flows need not necessarily lie exactly in the fault-line, but sufficiently near it for the growing shearing force to reach the limiting strength of the rocks at that point before it did at other points; nor is it necessary to suppose that the flows remain either constant in strength or in position; the contrary seems more probable; for if, as is natural to suppose, the forces which caused the earthquakes of 1868 and 1906 were of the same general character, the region of greatest shear, that is, the boundary between the flows, must have been in the neighborhood of the Haywards fault, about 30 km. (18.5 miles) further east, in 1868. Indeed, the displacements which occurred between the first two surveys indicate a somewhat different distribution of the flow from that suggested to explain the later displacements.

At first thought we might suppose that the movement of Mount Tamalpais in opposite directions relative to Mount Diablo in the two intervals between the surveys would indicate that it was on opposite sides of the boundary during these intervals respectively, but this would not necessarily follow. During the whole time that strains were being set up all points west of C moved to the north with respect to it; this relative movement in the second interval is represented on the eastern side of the fault by the distances between the lines $C''Q'$ and $C'''Q''$ in fig. 6; and if we consider the curves in the figure as similar

¹ The Geodetic Evidence of Isostasy. John F. Hayford. Proc. Washington Acad. of Sci., 1896, vol. VII, pp. 25-40.

curves, it can be shown that these distances are a little less than four-tenths the observed distances between $C'D'$ and $C''Q''$, at equal distances from the fault. The observed southerly displacement of Mount Tamalpais between 1874-1892 and 1906-1907 was 0.58 meter; its northerly displacement between 1874-1892 and the beginning of 1906 must have been about 0.22 meter; and therefore its actual southerly movement at the time of the earthquake must have been 0.8 meter; and the opposite displacements of Mount Tamalpais in the two intervals would have occurred independently of the shifting of the underground flows.

If instead of considering the displacements roughly symmetrical and in opposite directions on opposite sides of the fault-line, we prefer to consider that they were all northerly, the conditions are represented in figs. 15 and 16; they are satisfied by the supposition of a single, northerly flow extending for some distance to the west, increasing to a maximum at D and diminishing rapidly to zero in the neighborhood of O (broken line in fig. 16). The southern force between O and C would be referred to the resistance which the underlying material would offer to the displacement of the crust above it.¹

¹ Mr. Bailey Willis, on account of the forms of the mountain ranges bordering the Pacific Ocean, has concluded that the bed of the ocean is spreading and crowding against the land. He thinks in particular that there is a general sub-surface flow towards the north which would produce strains and earthquakes along the western coast of North America. *Science*, 1908, vol. xxvii, p. 695.

ON MASS-MOVEMENTS IN TECTONIC EARTHQUAKES.

THE MOVEMENTS BEFORE AND DURING EARTHQUAKES.

The following is the conception of the events leading up to a tectonic earthquake and of the earth-movements which take place at the time of the rupture, as developed by the observations and study of the California earthquake and by the comparison of these observations with what has been observed in other great earthquakes.

It is impossible for rock to rupture without first being subjected to elastic strains greater than it can endure; the only imaginable ways of rapidly setting up these strains are by an explosion or by the rapid withdrawal, or accumulation, of material below a portion of the crust. Both explosions and the rapid flow of molten rock are associated with volcanic eruptions and with a class of earthquakes not under present discussion; since earthquakes occur not associated with volcanic action, we conclude that the crust, in many parts of the earth, is being slowly displaced, and the difference between displacements in neighboring regions sets up elastic strains, which may become greater than the rock can endure; a rupture then takes place and the strained rock rebounds under its own elastic stresses, until the strain is largely or wholly relieved. In the majority of cases, such as when there is a general differential elevation or depression of adjoining areas, or where there are horizontal displacements, the elastic rebounds on opposite sides of the fault are in opposite directions. The directions of the slow relative displacements on the two sides of the rupture and of the elastic rebounds, all of which are practically parallel with each other, may be vertical, horizontal, or inclined.

The sudden displacements, which occur at the time of an earthquake, are confined to a zone within a few kilometers of the fault-plane, beyond which only the disturbances due to elastic vibrations are experienced. The distribution of the distortion of the rock at the time of the California earthquake shows that the elastic rebound and consequently the elastic shear was greatly concentrated near the fault-plane and was much reduced in intensity at even short distances from it; this concentration of the shear brought about a strain sufficient to cause rupture after a comparatively small relative displacement of the surrounding regions; if the shear had been more uniformly distributed over a wider region, a larger relative displacement would have been necessary to cause a rupture and there would have been a greater slip at the fault-plane. Therefore, altho it is quite conceivable that regions at a distance apart of, let us say, several times 20 km., might be relatively displaced and set up a state of elastic strain in the broad intervening area, it would be necessary that the relative displacements of the distant regions should be at least several times 6 meters, in order that the strain should become great enough to cause a rupture; and if the strain were less concentrated than it was in California, the relative displacements would have to be greater still. It is only in the case of very large earthquakes that a slip as great as 6 meters occurs; and we may therefore infer that it is only in the case of large earthquakes that the sudden elastic rebound is appreciable as far as 8 or 10 km. from the fault-plane.

The rupture does not occur simultaneously at all parts of the fault-plane; but, on account of the elastic qualities of the rock, it begins in a very limited area and spreads at a rate not exceeding the velocity of compressional waves in the rock.

We should expect that the slow accumulation of strain would, in general, reach a maximum value and bring about a rupture in a single, comparatively narrow fault-zone; and this is probably what occurs for the majority of tectonic earthquakes, but it is quite conceivable that the strains should become so great along two or more separated zones, that the vibrations, set up by the rupture of one, might be sufficient to begin the rupture of the second; or indeed, that the relief of strain at one might cause additional strain at the other and thus start the rupture there, tho this seems improbable if they are as much as 20 or 30 km. apart. But it does not seem possible that large blocks of the earth's crust could be suddenly moved as a whole; if the material under the block slowly sank, the elasticity of the rock would allow the block to follow, still resting upon the substratum, and only a zone between the sinking area and the surrounding regions would be elastically strained and experience a sudden elastic rebound when the rupture occurred; and if the sinking area were large, the irregularity of the movement would probably bring about ruptures on different sides at widely different times. If a limited region should be elevated, exactly the opposite movements would take place. It must not be inferred, from what has been said, that small narrow blocks, from a few meters to a few kilometers in width, may not be raised or dropt as a whole, but they should be lookt upon as small blocks, forming a part of a single fault-zone and playing a very minor part in the general disturbance of the earthquake.

The Mino-Owari earthquake of 1891, the Formosan earthquake of 1906, and the California earthquake of 1906 are good cases of earthquakes practically with a single fault-zone; whereas, the great earthquake in the central part of Japan in 1896 resulted from fractures along two roughly parallel fault-planes 15 to 18 km. apart, and the intervening region was elevated 1 to 3 meters; one of the fractures was considerably longer than the other; and there is no evidence of any connecting fractures, which would separate the elevated region into a block; the faults apparently die out, as faults usually do, and the elevation diminishes towards their ends and finally disappears completely. The two fractures occurred at about the same time, but no determinations were made exact enough to show that they occurred simultaneously. The sharply defined areas in Iceland over which the earthquakes of 1896 were severally felt suggest that they were due to the settling of successive blocks, and this idea is strengthened by the fact that the region is deprest and separated from the higher adjacent region by a fault. But the description given by Dr. Thoroddsen¹ does not indicate that the individual areas mentioned are bounded by faults, nor does he adduce any evidence that they sank at the time of the shocks, tho he does describe some large fissures which ran across several of them. Iceland is actively volcanic, and the descriptions of it suggest a very mobile condition not far below the surface. If this condition really exists, it would be much easier for cracks to form at approximately the same time and break up the crust into blocks there than in regions where the crust rests on a firmer foundation.

The elevations and depressions about Yakutat Bay, Alaska, which Messrs. Tarr and Martin have described as due to the earthquake of 1899, strongly suggest the movement of blocks;² but they did not find evidences of faultings on more than three sides of a block, and that in only one instance; tho it must be noted that they were unable to examine more than a very limited area and could not determine where the lines of fracture ended. It seems possible that the displacements they describe might be accounted for by an upward pressure, with or without a compression in a direction running north-northwest and south-southeast. Such a pressure and compression would bend the rocks into an arch, with the surface under tension, and the rupture would occur when this tension reached the limiting strength of the rock; the rupture would begin at the surface and

¹ Das Erdbeben in Island im Jahre, 1896. Petermann's Mitt. 1901, vol. XLVII, pp. 53-56.

² Recent Changes of Level in the Yakutat Bay Region, Alaska. Bull. Geol. Soc. Amer. 1906, vol. xvii, pp. 29-64.

extend downwards, and the ends of the broken rock would fly upwards, just as do the ends of a stick broken by bending, and an open fissure would be formed at the principal fracture; but along the side cracks the relative elastic rebounds might be in opposite directions and the parts might remain in contact. The principal fracture would be that in Disenchantment Bay, but no soundings have been made there to discover the existence of a fissure. Fissures and displacements of this character, due probably merely to compression, but on a very small scale, have been described.¹

We know very little about the interior of the earth or of the origin of the forces which produce such great changes at the surface. Great thrust faults exist which indicate tangential compressions; and normal faults, which indicate expansion. Great uplifts have occurred unaccompanied by compressions, due, apparently, to vertical forces; and the California earthquake has emphasized the existence of horizontal drags below the crust. Future study may reveal forces applied in other ways; but it is not going too far to say that whenever ruptures occur, they result from elastic strain, and the sudden movements produced are merely elastic rebounds; and moreover, except in the case of earthquakes connected directly with volcanic action, the strains have not been set up suddenly, but are gradually developed by the slow displacements of adjacent areas. And severe earthquakes caused by shearing strains, vertical, horizontal, or oblique, where the elastic rebounds are in opposite directions on opposite sides of the fault, which remain in contact, will be more common than those due to the tensional strains of bending, where the elastic rebounds are in the same direction and a gaping fissure is opened.

THE PREDICTION OF EARTHQUAKES.

As strains always precede the rupture and as the strains are sufficiently great to be easily detected before the rupture occurs, in order to foresee tectonic earthquakes it is merely necessary to devise a method of determining the existence of the strains; and the rupture will in general occur in the neighborhood of the line where the strains are greatest, or along an older fault-line where the rock is weakest. To measure the growth of strains, we should build a line of piers, say a kilometer apart, at right angles to the direction which a geological examination of the region, or past experience, indicates the fault will take when the rupture occurs; a careful determination from time to time, of the directions of the lines joining successive piers, their differences of level, and the exact distance between them, would reveal any strains which might be developing along the region the line of piers crosses. In the case of vertical, horizontal, or oblique shears, if the surface becomes strained thru an angle of about $1/2000$, we should expect a strong shock. It would be necessary to start with the rock in an unstrained condition; this could readily be done now in the neighborhood of the San Andreas fault. The monuments set up close to the fault-line (vol. I, pp. 152-159) were not placed with this object in view, but with the object of measuring actual slips on the old fault-line. Measures of the class described would be extremely useful, not only for the purpose of prediction, but also to reveal the nature of the earth-movements taking place, and thus lead to a better understanding of the causes of earthquakes. Less definite, but still valuable, information could be obtained by the simpler process of determining, from time to time, the absolute directions of Farallon Light-house and Mount Diablo from Mount Tamalpais; by this means northerly or southerly movements of 1 foot of either of the first two stations relative to the third could be detected; and we should know if strains were being set up in the intermediate region; but we could not tell where the strain was a maximum nor to what extent it may have been relieved by small displacements on intervening fault-planes.

¹ F. Cramer, *Am. Jr. Sci.*, 3d Series, 1890, vol. xxxix, pp. 220-225; and 1891, vol. xl, pp. 432-434. Mr. H. P. Cushing has shown me pictures of similar cracks with elevated lips in central New York.

It seems probable that a very long period will elapse before another important earthquake occurs along that part of the San Andreas rift which broke in 1906; for we have seen that the strains causing the slip were probably accumulating for 100 years. There have been no serious earthquakes reported along this part of the rift, except at its southern extremity, since the country has been occupied by white men, altho strong earthquakes have occurred in neighboring regions. It seems probable that more consistent results might be obtained regarding the periodicity of earthquakes if only the earthquakes occurring at exactly the same place were considered in the series. The Messina earthquake of December 28, 1908, seems to have resulted from a movement on the great fault passing thru the Straits of Messina. The last strong movement at the same place seems to have occurred in 1783; tho the Calabrian earthquake of 1905 may have been caused by a movement on another part of the same fault.

It is quite possible, however, for strong earthquakes to occur on neighboring faults after short intervals. The ruptures of the Haywards fault in 1868 and of the San Andreas fault in 1906 are a fair example, tho the interval is rather long. The Iceland earthquakes of 1896, already referred to, illustrate this much better. Five strong shocks occurred within fifteen days; but they were central, not in the same region, but in regions successively more and more to the west.

When a rupture occurs, the elastic rebound may carry the sides of the fault beyond their positions of no strain, and the friction may temporarily hold them there; or the friction may be so great that they do not entirely reach these positions. In either case further shocks may be expected before long; but they are apt to be slight, and are more likely to constitute *after-shocks* than independent earthquakes.

SHEARING MOVEMENTS IN THE FAULT-ZONE.

CHANGES IN THE LENGTH OF LINES.

In the general descriptions of the fault-trace it is shown that when the rupture occurred there was a zone of varying width between the shifting sides which did not partake of their simple movements, but was more or less distorted by the shearing forces to which it was subjected. The existence of this zone in alluvium or disintegrated rock may be explained even tho the fault were a sharply defined crack in the underlying solid rock. Let us suppose that the straight line AOC in the rock (fig. 17) has been broken at the fault and displaced into the two parts $A'O'$ and $D'C'$. If the alluvium were brittle and with little plasticity, it might be broken and displaced in the same way, but if it were plastic, as it would be if it were to some extent composed of clay, a part of the displacement would be accomplished by shearing distortion, and the offset at the fault-plane would be less than that of the underlying rock. Close to the rock the displacement of the alluvium would be very nearly the same as that of the rock (lines 1 in the figure); at greater distances, however, the distortion in the vertical plane would make itself felt; the offset would be less, and the displacement would be distributed more like the lines 2. The alluvium might be so thick or plastic that it would suffer no break at the surface along the fault-line, the whole displacement being distributed like line 3; this seems to be the condition which produces the *echelon phase* of the fault-trace in very wet alluvium, as described by Mr. Gilbert (vol. 1, p. 66).

Special phenomena were exhibited in this zone of shearing distortion which might easily be misunderstood, but which can be explained fully on mechanical principles.

The zone was in some places only 2 to 6 feet wide, in others several hundred yards. Where it was broad the shift was divided in some cases among a number of cracks; in others it was distributed more or less evenly over the zone; in all cases, we have a zone of greater or less width subjected to shear; let us see what compressions and extensions take place in it. Let W and E (fig. 18) be the eastern and western boundaries of the sheared zone, whose width is l and let W move a distance s , short in comparison with l ; and let all other lines parallel with the boundaries also move a distance proportional to their distance from E . WN will be the direction of this motion;

the line Ec , which makes an angle a with WN , a being positive to the right of WN , is shortened by an amount cd ; and the simple geometry of the figure shows that the total shortening equals $s \cos a$; and this is independent of the length Ec , provided only that the line Ec does not materially change its direction during the motion; this is, in general,

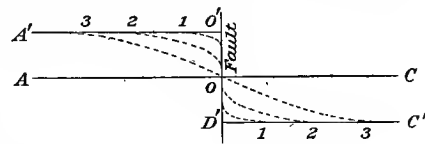

FIG. 17.

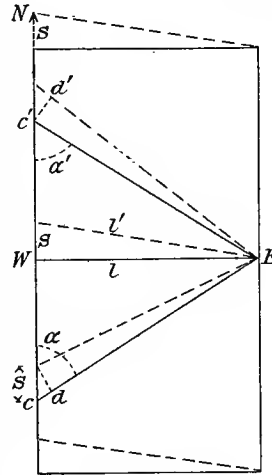

FIG. 18.

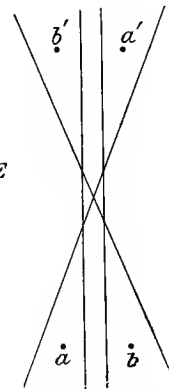

FIG. 19.

equivalent to saying that s must be small in comparison with Ec . It is evident that if the line had the position Ec' , where $a' = a$, it would be lengthened by the same amount that Ec is shortened.

Suppose we stand in the acute angle between the shearing zone and a line crossing it; if the line is on our left, as in the position a (fig. 19), we say it crosses the zone from left to right; if it is on our right, as in position b , we say it crosses from right to left. For the same line it makes no difference whether we are in the position a or a' . With this convention we can state that if a line crosses the sheared zone from left to right, it will be shortened; if from right to left, it will be lengthened; and this is true without any compression of the sheared zone at right angles to the direction of the movement. The total change in length is zero when the line is at right angles to the direction of the shift, and is greatest when it approaches parallelism with it.

To determine the change in length per unit length of the line we must divide $s \cos a$ by Ec or $l / \sin a$, which gives $(s / 2l) \sin 2a$; this is a maximum when a equals 45° ; there is therefore a tendency to form open cracks crossing the zone from left to right and making an angle of 45° with its direction. This direction would be modified by pressure or tension at right angles to the sheared zone; compression would make smaller cracks more nearly at right angles to the trend of the fault-zone; tension would make them larger and more nearly parallel with it. The very general existence of cracks making an angle of about 45° with the direction of the fault-trace shows that there was neither compression nor expansion at right angles to the fault for at least a large part of its course.

If the sheared zone is so narrow that a line crossing it is broken and the two ends separated, as in fig. 20, it is shortened or lengthened by an amount $s' \cos a$.

It may happen that a part of the movement is concentrated along a narrow crack and a part is distributed over a zone on the sides of the crack; so that the straight line l in

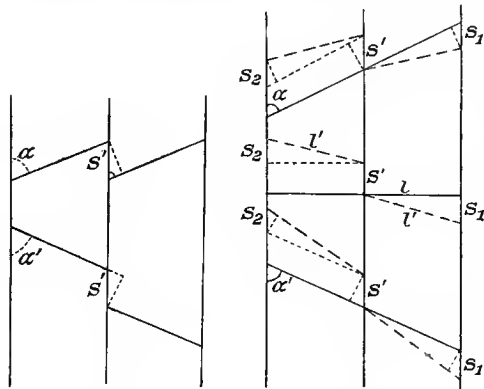

FIG. 20.

FIG. 21.

fig. 21 is changed into the two broken lines, l', l'' . A line crossing the zone from left to right will be shortened by an amount equal to the sum of the shortenings at the crack and in the zone of distributed shear, that is, by $(s_1 + s_2 + s') \cos a$, and a line crossing from left to right would be lengthened by an equal amount. But $s_1 + s_2 + s' = s$, the total shift of the boundaries of the sheared zone, so that we can say in general, *a line crossing the sheared zone from left to right is shortened, and one crossing from right to left is lengthened, by an amount equal to the total relative shift of the boundaries of the zone multiplied by the cosine of the acute angle between the line and the direction of the shift.* If therefore we measure the shortening or lengthening of a line crossing the sheared zone and the acute angle we can calculate the amount of the shift, whether the shift be concentrated in a narrow crack or distributed over a wider zone.

CRACKS IN THE GROUND.

Let us apply these simple results. When the shift is concentrated in a narrow zone, only a few feet wide, there is more or less demolition, within the zone, of a fence or other object that may cross it, and the broken ends of the fence receive an offset which gives a measure of the shift. The turf in such a narrow zone is torn in a characteristic way; at the beginning of the movement the turf is rent into strips by cracks formed at right angles to the line of greatest stretching; that is, the cracks and the strips of turf between

them would trend about north and south, as the fault runs about northwest. The subsequent movement seems in many places not to have obliterated this arrangement of the turf in strips, which is so characteristic that it indicates the position of a fault-trace without possibility of error, and shows the direction, tho not the amount, of the relative movement of the sides. Its appearance is shown in plates 16B, 39B, 43B, and it is sketched diagrammatically in figs. 18, 19, 20, vol. 1.¹ An interesting example is shown in plate 65A and fig. 57, representing an auxiliary fault at the Morrell ranch; the direction of the diagonal cracks across the road shows that the northeastern side moved relatively to the northwest, a direction contrary to the movement observed elsewhere. This unexpected result is confirmed by the offsets of the fences bordering the road; a picture of the right-hand fence is shown in plate 64B, and a measure of the offset shows a relative movement of 3.75 feet. This anomaly is local and apparently very superficial, as it does not appear in the tunnel which is nearly under the point observed; the tunnel is offset normally a short distance to the east of the auxiliary fault.²

In places the subsequent motion has so broken up and so confused the earth clods that the regular diagonal cracks have been obscured; in places a slight compression or extension at right angles to the fault has entirely closed the cracks or made others more nearly parallel with the fault; but it is surprising how generally traces of the diagonal cracks can be seen when they are lookt for. They are frequently described by the word *splintering*.

If the sheared zone runs along a slope, gravity acts as a tension on the higher part of the zone, increasing the tendency to form cracks and making them more nearly parallel with the fault-trace; in the lower part it produces a compression which tends to prevent the formation of cracks. This is the condition near San Andreas Lake (vol. 1, p. 93).

Other cracks were made which apparently were not due to the shearing movements in alluvium which we have been considering; some, such as those in the Point Reyes region and those on Black Mountain (vol. 1, pp. 75, 107) seem due to a general shattering of the mass, and may be caused by vibratory motion (vol. 11, p. 40); others (vol. 1, pp. 106-109) which are nearly parallel with the fault may in some cases be due to the topography, and in others to a small relative upthrust of one side of the crack.

In all parts of this report special efforts have been made to distinguish between cracks and dislocations due to the actual rupture along the fault, and those due to landslides, the settling of unconsolidated material, the slumping of river banks, the effects of vibrations, etc. This distinction is very important in order to interpret correctly the true movements of the underlying rock.

OFFSETS OF FENCES AND PIPES.

The distribution of shear over a broad zone is well illustrated by the distortion of fences; a number have been described in the preceding pages and illustrated by photographs and figures; we may refer especially to figs. 15, 31, 32, vol. 1. In some cases anomalies occur, which are probably not real, but which may be due to a misinterpretation of the observations; in fig. 29, for instance, the fence on both sides of the fault-line is dragged in the same direction, with shifts of 13 feet and 5 feet 9 inches on the two sides, respectively; at a distance from the fault-line there is only a very small, relative displacement of the opposite sides; this is so opposed to the general character of the displacements that it probably does not represent the true movements. In fig. 38 a fence is represented as having been distorted to the south on the eastern side of the fault, for

¹ Professor Omori describes and explains this effect of the shear in his account of the earthquake in Bull. Imperial Earthquake Investigation Commission, vol. 1, No. 1, pp. 12-15.

² See Mr. Johnson's description, vol. 1, top of page 277. Fig. 57 is badly drawn and shows the offset in the wrong direction.

a length of about 1,800 feet. There is no evidence that the zone of distributed shear had

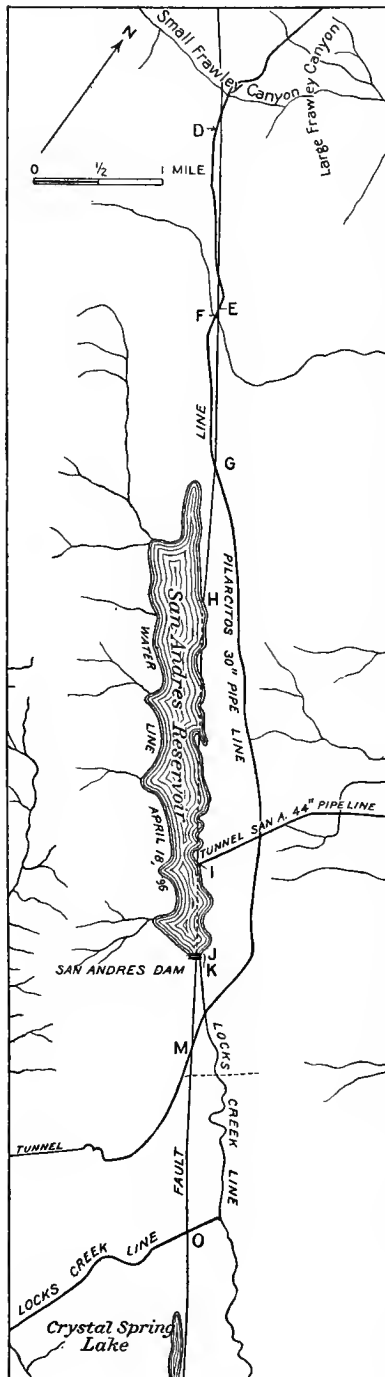

FIG. 22.

The pipe again crosses the fault near the head of San Andreas Lake, from right to left (*G*), and was pulled apart in two places a total of 6 feet 8 inches (plate 59A); this, with an offset of 6 inches, indicates that the angle between the pipe and the fault was but 3.5° .

such a breadth in this neighborhood, and moreover the displacement of the fence is in the wrong direction to be explained by this means. Nor can we refer it to elastic rebound as described on pages 17–20 for the angle of shear would be more than $1/500$ or about 7 minutes of arc, which is much greater than can be allowed. The displacements of the fence are measured from its inferred original position supposed to be a straight line, but we are not informed how the original position was determined. It would not be permissible to infer its direction from the continuation of the fence outside the eastern stone monument; and if the records of the original surveys gives the magnetic direction of the line, an imperfect knowledge of the magnetic declination and instrumental errors (if the line was run with a compass) would easily account for the deviation of 7 minutes between the present line and its supposed original direction. It seems probable therefore that the true distortion was confined to a comparatively short length of the fence. There seems no clear explanation of the bow-shaped distortion of the fence in fig. 34, unless the fence originally had this shape.

The Pilarcitos 30-inch wrought-iron pipe of the Spring Valley Water Company runs near the fault for a distance of two miles northwest of San Andreas Lake and crosses it four times (vol. 1, p. 95). The map (fig. 22), taken from the report of Mr. H. Schüssler, chief engineer of the company, shows the location of this and of some other pipes of the company. Beginning at the northwest the pipe crosses from left to right at Small Frawley Canyon, and the angle between the pipe and the fault-line is 20° ; the shortening of the pipe is 7 feet 3 inches, and the offset is 15 inches, corresponding to a total shift of 8 feet, as determined by the formula on page 34.

We have no information about the break at the next crossing, from right to left, and about a mile distant; the pipe runs nearly parallel with, and close to, the fault between these crossings and suffered many ruptures; in one place it completely collapsed.

At the next crossing (*F*), very near the last, the pipe crossed from left to right at an angle of 15° ; it was crushed in three places, the total shortening being 9 feet 8 inches (plate 59B and p. 96, vol. 1); this corresponds to a shift of 10 feet.

A half mile southeast of San Andreas Lake the pipe crosses the fault for the last time (*M*), from left to right at an angle of 65° (vol. 1, p. 100); it was crushed and shortened 22 inches; 100 feet to the north it was crushed again, the compression there being 1 foot. The total shortening, 2 feet 10 inches, corresponds to a shift 6.75 feet; as the shift at the fault-line was only 20 inches, a part of the shear must have been distributed.

Near the northwestern end of Crystal Springs Lake the 44-inch Locks Creek pipe crosses the fault-zone from left to right at an angle of 65° (fig. 22, *O*, and vol. 1, p. 101, fig. 39); it was crushed at four points, and pulled apart 3 inches at one point; the total shortening was 59.25 inches; this corresponds to a total shift of 11 feet 8 inches, the greater part of which was distributed.

The shifts indicated by the changes in length of the pipes must be looked upon in many cases as smaller than the true shift, for many other ruptures occurred, which are noted in the report of the chief engineer of the water company, but of which no details have been given.

EFFECTS ON OTHER STRUCTURES.

The two best examples of combined shortening and stretching are furnished by the gate-well on the shore of San Andreas Lake and by the flume and the waste-weir at the southeastern end of the lake; they show the existence, at the same place, of shortening and stretching in different directions, altho there is no indication of a compression or extension at right angles to the fault. The gate-well was stretched in a direction $N. 79^\circ W.$ and shortened at right angles to the stretching (vol. 1, pp. 98, 99, fig. 35). The direction of the fault-trace is about $N. 35^\circ W.$, so that the directions of greatest stretching and shortening make angles of practically 45° with the directions of the fault. From the scale of the figure the stretching is found to be 3 feet 4 inches, which corresponds to a shift of 4 feet 8 inches. This is less than the shift in this part of the fault and confirms the evidence, furnished by cracks in the ground, that the shear was distributed over a greater width than 18 feet, the projection of the diameter of the well (25 feet) in the direction of greatest stretching upon a line at right angles to the fault-trace.

The Locks Creek flume, a 44-inch wrought-iron pipe, crosses a part of the sheared zone from right to left at an angle of 15° (vol. 1, pp. 99, 100; fig. 36); it was pulled apart 4 feet, corresponding to a shift of 4 feet 2 inches. If the pipe had entirely crossed the sheared zone, it would have indicated a greater shift, which could not have been less than 7 feet at this point, according to the displacement of a fence shown in the same figure; the flume passes thru a concrete culvert and continues to San Andreas Lake; as this part of the pipe and culvert were parallel with the direction of the shear, they were uninjured. 275 feet from the break in the flume a strongly built brick waste-weir tunnel crosses the sheared zone from left to right at an angle of about 57° ; its great strength prevented it from being entirely destroyed, but it was crushed at the fault-line and shortened, tho the amount was not measured.

The examples given show very clearly that the shortening and stretching of lines in the fault-zone was not due to any general expansion or compression causing changes of area, but to shear; and the character and amount of change in length of any particular line depended on the direction in which it crossed the fault-zone and the angle it made with the direction of shift; so that, in some instances, of two lines crossing the fault-zone at the same point but from opposite sides, one was lengthened and the other shortened. It is quite possible that there were, in places near the surface, slight expansions or compression at right angles to the fault-line. As pointed out (vol. 1, p. 73) the fault-plane can not be considered a mathematical plane, and the movement must have caused a slight separation of the sides in places near the surface, which may be indicated by the trench-form of the fault-trace. It is difficult to understand how the two sides of the

fault could be made to approach each other in the region of solid rock at a distance below the surface, but it is quite possible that the more unconsolidated material near the surface might be shaken together by the earthquake. An illustration of this may perhaps be found in the compression of the fence and the sagging of the telephone wire which cross the causeway dam between the Crystal Spring Lakes, approximately at right angles to the fault (vol. 1, p. 102).

The shortening of the railway track by 7 inches between Wright and Alma (vol. 1, p. 110), a distance of 5 miles, can hardly be referred to distributed shear; the track has many curves and runs in places by the sides of steep mountain slopes; and a slight shaking down of the roadbed in places might straighten the track sufficiently to shorten it by this small amount.

VIBRATORY MOVEMENTS AND THEIR EFFECTS.

CHARACTER OF THE MOVEMENTS.

When the rupture occurred on the fault-plane, it is probable that the movement did not begin at the same moment at all parts of the plane; it probably started in some limited region, and the stress, being relieved by the break there, was concentrated upon nearby points which gave way, and thus the rupture spread from point to point until it extended over the whole fault-plane; and it is also probable that the whole movement at any point did not take place at once, but that it proceeded by very irregular steps.

We can determine roughly the time which would have been required for the rock to come back to its natural position of equilibrium if it had vibrated freely without friction. The period of vibration of the rock, distorted by simple shear, as explained on page 50, is given by the expression $T_0 = 4H\sqrt{\rho/n}$; where H , the distance from the fault-plane to which the distortion extends, may be taken as 6 km. (3.7 miles), ρ is the density of the rock, say, 2.6; and n is the coefficient of rigidity, say 2×10^{11} dynes per square centimeter (2,900,000 pounds per square inch).¹ With these values of the constants we find the total period to be about 8.7 seconds, or the time for the rock to move from its original displacement to its position of equilibrium one-fourth of this, or 2.2 seconds. This is found from the equation of the free vibration of the rock, in which case the straight line at right angles to the fault is distorted so as to be concave toward its position of equilibrium; but the observations in fig. 5 (page 16) show that the rock was distorted with the convex side toward the position of equilibrium. If therefore the break had been sharp, with no friction at the fault-plane, we should have had vibrations containing higher harmonics, so that the rock at the fault-plane would have made rapid but short vibrations back and forth during the 2.2 seconds necessary for it to reach the equilibrium position. This, however, was not what actually occurred; small slips took place at different parts of the fault-plane, and as the results of these successive slips and the great friction, some 30 to 60 seconds were required before the rock came to rest; and even then certain parts of the rock were apparently still held in a strained condition by strong friction, and from time to time gave way, producing the aftershocks which are listed in another part of the report.

The more or less sudden starting and stopping of the movement and the friction gave rise to the vibrations which were propagated to a distance. The sudden starting of the motion would produce vibrations just as would its sudden stopping; and vibrations are set up by the friction of the moving rock, exactly as the vibrations of a violin string are caused by the friction of the bow; the string vibrates altho the bow is drawn steadily across it; or as vibrations are set up in a finger-bowl when a wet finger is drawn along the edge; in this case we can see the vibrations transmitted to the water in the bowl.

Vibrations once started are propagated as elastic waves in the rock and consist in general of compressional waves like simple waves of sound, in which the vibratory movement of any particle is in the direction of propagation; and of transverse waves like those of light, in which the movement of the vibrating particle is at right angles to the direction of propagation. As a compressional wave advances, the mass of rock thru which it passes is subjected to successive compressions and extensions.

¹ See p. 21.

CRACKS FORMED IN THE GROUND AND THE BREAKING OF PIPES.

We can readily determine the amount of compression and extension that takes place; the movement of an earth particle is given by the expression

$$y = A \cos 2 \pi \left(\frac{t}{P} - \frac{x}{\lambda} \right)$$

where A is the amplitude, P the period, λ the wave-length, t the time, and x the distance, measured in the direction of propagation; the compression and extension is given by

$$\frac{dy}{dx} = -\frac{2 \pi A}{\lambda} \sin 2 \pi \left(\frac{t}{P} - \frac{x}{\lambda} \right)$$

and its maximum value is $2 \pi A / \lambda$. For a wave whose period is a half second and whose velocity is 4 miles a second, λ would be 2 miles or say 10,500 feet, and if A were 0.2 of a foot, the wave would cause successive compressions and expansions of short lengths of rock amounting to 1 : 8350 of the length. If c is the compression or expansion per unit length and M the modulus of elasticity, which for granite with a free upper surface would be about 7.66 million pounds per square inch, the force exerted is cM , or, in the case of the above wave, $\frac{7.66 \times 10^6}{8350}$, or 920 pounds per square inch. This is much less than the force necessary to break granite by crushing (6 to 10 tons per square inch), but the strength of granite under tension must be less than under compression, altho its value is not known.

Cast-iron, which resembles granite in its general structure, requires four or five times as large a force to break it by crushing as by stretching; it therefore seems possible that the numerous cracks observed in the region west of Point Reyes station may be due to the vibrations. In the case of vibrations passing thru alluvium or decomposed rock, the wave-length will be shorter, the amplitude greater, and the breaking strength much less in comparison with the modulus of elasticity; so that we should expect in places, where the condition of the ground is favorable, even at a distance from the earthquake's origin, that cracks would open and close at right angles to the direction of propagation; it is to this cause we must refer the opening of cracks and the projection of water, mud, and sand into the air, which has frequently been described in connection with strong earthquakes. This phenomenon was seen in the neighborhood of Salinas (vol. 1, p. 245). In very unconsolidated deposits cracks may be left open by the compression of the intervening material and water arising in the cracks may form craterlets (vol. 1, pp. 229, 231, 338); but cracks formed by slumping of the ground, altho started by the vibrations, are practically due to gravity.

Pipes in the ground were subjected to similar compressions and extensions, the measure of the force being Ec , where E is Young's modulus for the material of the pipe. For cast-iron E is about 5,000 tons to the square inch and with an extension of 1 : 8,350, the force tending to rupture it would be about 0.6 ton to the square inch. For wrought-iron E is about 13,000 tons to the square inch and the force developed by the above expansion would be 1.6 tons; it requires from 20 to 28 tons to break wrought-iron by tension, and 16 to 20 tons by crushing; but at the joints the pipes are weaker. On the whole, not many pipes in the ground were broken by the vibrations, tho the stronger vibrations in alluvial soil must have broken a number. A very good example is the pipe near Salinas (vol. 1, p. 245), which was broken in many places; in some places the ends were separated as much as 3 feet, in others they overlapt as much as 4 feet; and they showed that they had been hammered together and had not simply been pulled apart. A pipe seen near Alvarado had had the same experience (vol. 1, p. 305).

In the calculations above we have supposed the pipe so firmly embedded in the surrounding earth that it moves with the earth; under this supposition the strength of the pipe to resist rupture due to vibrations would not be changed by altering the thickness of the pipe; but if the pipe slips in the ground, as it might if it were very straight for distances of half a wave-length or more, it might be strengthened by making it thicker; but it is hardly practicable to lay pipes straight for such distances, and therefore we should not seek to strengthen pipes in the ground by making them thicker; but they would be strengthened by selecting a material with a large ratio of its breaking strength to its Young's modulus. Wrought-iron pipes would yield by crushing rather than by tension, whereas cast-iron would yield first by tension; but it would require a stronger vibration to pull apart a cast-iron pipe than to crush one of wrought-iron. In general, however, the joints are the weakest spots and the ruptures occur there.

The Spring Valley Water Company sends water to San Francisco thru three pipes (map No. 21, and fig. 22). The San Andreas pipe draws directly from the lake of the same name; altho it starts at the fault-line it was ruptured at one place only, where it crosses a marsh at Baden Station on a trestle. The pipe here was weakened by an extension joint, the two ends being held together by wires passing over lugs on the pipes; these lugs were pulled out. The lack of injury to the pipe at other places shows that, where buried in the ground, it was quite strong enough to stand the compressions and extensions due to the vibrations, and makes it probable that the many injuries received by the two other pipes, not along the fault-line, and of which we have no details, were due to some special causes of weakness at the points where they occurred. When the pipe was buried, it was prevented from bending and was then strong enough to remain intact, but where it was carried on a high trestle, or on a trestle over a soft marsh, bending was possible and its power of resistance was similar to that of a column under compression; as is well known, a column yields, not by crushing, but by bending.

The Pilarcitos 30-inch wrought-iron pipe is carried across Large Frawley Canyon on a high trestle about half a mile east of the fault (plate 100A); the pipe is buried on each side of the canyon, the intervening length being 100 feet; this portion was broken into two pieces of practically equal lengths which, together with the greater part of the trestle, were thrown into the canyon and left side by side, 50 or 60 feet from their original position. The ruptures occurred at riveted joints, the two pieces being otherwise intact. It is clear that the portion of the pipe on the trestle must have acted like a column with fixt ends. The formula which most accurately represents the strength under these conditions is known as Rankine's formula,¹ and is

$$p = \frac{f}{1 + cL^2/k^2},$$

where p is the pressure in tons per square inch necessary to cause the collapse, and f and c are constants, the first dependent upon the material of the column only, the second both upon the material and upon the character of the ends; L is the length of the column and k is the radius of gyration of the cross-section. For wrought-iron f is 16 tons per square inch; c is 1 : 36,000 for a pipe with fixt ends; $k^2 = \frac{d^2}{8}$, where d is the average of the inside and outside diameters; so that the formula becomes

$$p = \frac{16}{1 + \frac{1}{4500} \left(\frac{L}{d}\right)^2}.$$

The length of the pipe over Large Frawley Canyon is 100 feet and the diameter 2.5 feet, therefore $\left(\frac{L}{d}\right)^2$ is 1,600, and p , the pressure necessary to break it, becomes 11.8 tons per

¹ Ewing's Strength of Materials, p. 178.

square inch. The compressive force due to the vibrations calculated in the example we have used (with Young's modulus for wrought-iron equaling 28,000,000 pounds per square inch) is only about one-eighth as great, but at this short distance from the fault-plane it is possible that the vibrations may have been greater, and without doubt, the pipe itself, on account of the joints, would give way under a much smaller pressure than is required by the above formula; we must believe that the pipe yielded like a column under compression, and the sudden removal of the resistance when the rupture came allowed the elastic forces to throw the pieces 50 or 60 feet to the side.

The Crystal Spring 44-inch pipe suffered in the same way where it crost the San Bruno marsh near South San Francisco and the Guadeloupe and Visitacion marshes a little further north. The trestle which carried the pipe over these marshes was built on deeply driven piles. The pipe was broken in many places and the pieces flung 4 or 5 feet to right and left; the trestle was also demolisht, but the piling and its capping were in general uninjured. In some instances, however, the pipe seems to have been raised into the air and to have come down with sufficient force to destroy the trestle and crush the heavy timbers bolted to the tops of the piles. Altho the vibrations in these marshes must have been very violent, it was found after the earthquake that no permanent displacement had taken place; the piling had not lost its alinement nor its grade.

It does not seem probable that the lateral vibration was strong enough to break the pipe and throw the pieces 4 or 5 feet; the pipe must have been quite flexible enough to yield to such vibrations without breaking; nor is it probable that the vertical vibration was strong enough to throw the pipe upwards; it is most probable that we have here again to do with compressional vibrations, acting upon parts of the pipe as upon columns with round ends, for the ends of the short lengths of the pipe, over which the compression was strongest, were practically free to turn the small amount required. We suppose the vibrations to be communicated to the pipe thru the trestle and to be transmitted along the pipe as forced vibrations, with the same period and velocity, and therefore with the same wave-length, as in the underlying marsh; but there would undoubtedly be propogated in the pipe vibrations having a velocity appropriate to the material of the pipe, and these would in places combine with the forced vibrations, to produce unusually large forces of compression and tension.

Rankine's formula for the yielding of columns with round ends becomes

$$p = \frac{16}{1 + \frac{4}{4500} \left(\frac{L}{d}\right)^2}$$

With a 44-inch pipe L/d would be 40 for a length of about 150 feet, and p , the force necessary for collapse, then becomes 6.6 tons per square inch; which is about 4 times the pressure calculated in the example we have taken above; but in the marshes the wave-length would be greatly reduced, and there seems no difficulty in believing that the compressions were in places sufficient to break the pipe regarded as a column with rounded ends (especially at the joints), and then to fling the pieces to the side. Where the pipe had a slight bend in the vertical plane, the compression would throw it up rather than to the side, and in this way its subsequent blow upon the support is made clear. One piece of pipe, about 800 feet long, was found lying on the ground by the broken trestle uninjured except at its ends; it must have rolled off the trestle after the supporting sides had been battered off.

The San Bruno marsh is about 2 miles from the fault-line and the other two marshes about twice as far. The increase intensity of vibration due to the character of the foundation far more than made up for the diminisht intensity due to distance, as shown by the distribution of isoseismals on map No. 23.

CRACKS IN WALLS AND CHIMNEYS.

In Mallet's great report on the Neapolitan earthquake of 1857 he assumed that the waves were propagated thru buildings just as thru the earth below, and concluded that the cracks made in the walls were at right angles to the direction of propagation of the waves. From this he deduced the direction of propagation and the position of the focus. But the length of buildings is only a very small fraction of the length of a seismic wave; and in them the proper conditions for the rectilinear propagation of waves do not exist; so that Mallet's assumption and his conclusions can no longer be accepted. Lines drawn at right angles to the cracks on the floor are probably at right angles to the direction of propagation of longitudinal waves, for these cracks are practically formed in the ground, like those described above; but cracks in walls can not be looked upon as at right angles to the direction of the movement, even when no windows are present to cause special weakness in some directions. We shall form a better conception of the mechanical conditions if we look upon the wave as divided into two components, one producing a horizontal vibration of the house and the other a vertical vibration. If, as is usually the case, the house is longer than it is high, the inertia opposing the motion will produce a horizontal shear and it may be shown, by the method used on page 34, that cracks have a tendency to form at an angle of 45° with the horizontal in walls running in the direction of the vibration; as the motion is first in one direction and then in the other, two sets of cracks would be formed at right angles to each other, and each 45° with the horizontal. The vertical component produces vertical compression and expansions which may slightly modify the direction of the cracks. This is exactly what was observed; many walls exhibited the double system of diagonal cracks. An excellent illustration of these cracks in the St. James Hotel at San Jose is given by Professor Omori.¹

Chimneys, and walls running at right angles to the direction of the vibrations, were affected in a different way; they are high in comparison with their breadth and consequently were set into vibrations, like long rods. As they swayed back and forth they bent and were compressed on the concave and stretched on the convex sides. If this stretching exceeded the elastic limit of the material, a horizontal crack was made. It was in this way that chimneys were overthrown and the tops of walls and gables were thrown out. In practically all cases of brick walls and chimneys the break occurred at a joint and the bricks which were thrown down were usually unbroken, but entirely detached from each other, showing that the mortar was very weak. Chimneys of uniform thickness would naturally break at their lowest free point, which, in the case of the chimneys of houses, is where they pass thru the roof; and walls would break where they are not well braced, which was usually near their tops or in the gables or at the corners. The high chimneys of factories are thicker near the ground and gradually diminish in diameter and thickness from the ground up. They did not break at the ground, but at some point about a third of the way up where the bending moment was greatest in comparison with their strength. It by no means follows that a broken chimney will fall; in regions where the shock was not so very strong, many short chimneys were broken, and the detached part rocked on the lower part without overturning; the very small power of stretching possessed by brick and mortar caused chimneys to break before they were sufficiently inclined to lose their balance and fall.

ROTATORY MOVEMENTS AND THE ROTATION OF OBJECTS ON THEIR SUPPORTS.

It has been a matter of frequent observation that during the shocks of large earthquakes a twisting motion is felt, and after the shock, chimneys which were not thrown down, monuments in cemeteries, ornaments, etc., are found to have been rotated on their

¹ Bull. Imperial Earthquake Investigation Commission, vol. I, No. 1, plate iv.

supports. This has given rise to the belief that there is a rotary motion of the various parts of the ground like that of wheels about their axes. It should be pointed out that this kind of motion can not exist, for it could not be propagated as an elastic disturbance, but would break up into waves of compression and distortion, which would be propagated at different speeds and would soon be separated from each other. Moreover such a motion would produce rents in the ground, which have not been found; nor has any such motion of the ground itself ever actually been observed. Waves of elastic distortion do, however, produce very small rotations, whose maximum amount, we shall see (page 146), is given by the expression $\frac{2\pi A}{\lambda}$, where A is the amplitude and λ the wave-length; with a wave as short as 10,000 feet (3 km.) and an amplitude as large as 0.2 of a foot (6 cm.), the maximum rotation would only be about 0.25 of a minute of arc, a quantity far too small to be noticeable; even if the rotation were 100 times as great as this, it would probably not be noticed.

But there is another kind of rotation, which undoubtedly does occur, and which would, if strong enough, give rise to the sensation of twisting and would cause objects to rotate on their supports. If a swinging pendulum, as it passes its lowest point, should receive a blow at right angles to the direction of its motion, it would simply change its direction and continue to swing back and forth in a different plane; but if the blow should be received at any other part of its motion, it would swing in an ellipse; if the blow were of the right intensity and were received at the end of the swing, the pendulum would swing in a circle.

Two vibrations making an angle with each other would produce just such an elliptical or circular motion, unless they were so adjusted that they would combine to make a simple linear vibration in a direction between the two; but this would rarely occur. If the two groups of combining vibrations had different periods, the resulting movement would be very complex; and we might have rotations first in one direction and then in the other. The kind of rotatory motion thus set up is not like that of a wheel about its axis, but is like that of a book which is carried around in a circle keeping the edge always parallel to its original position. We must look upon the rotatory motion of the earth reported during earthquakes as such that every point describes an ellipse, each point with a different center, but all with parallel axes; and the lines connecting near-by points remain parallel to their original directions, and do not, as in the case of a wheel, also rotate. For the sake of clearness let us speak of this kind of motion as *parallel rotation*, to distinguish it from rotations where the various points rotate around the same center.

We have conclusive evidence that the motion of the earth during the Californian earthquake was not merely a to-and-fro motion in one direction, but that the direction of the motion changed markedly. This is shown by the sensations of observers and by the fact that objects in the same place were thrown in various directions; statements that the earthquake was a "twister" were not uncommon, and some observers reported that the motion was first in one direction and then at right angles to it; and lastly the seismographs themselves indicate a combination of simple vibratory motions; this is well shown in the seismogram made by the simple pendulum at Yountville, and in all made by Ewing duplex pendulums. (See Seismograms, sheet No. 3.)

We can picture to ourselves many ways in which movements in different directions could be produced at the same time. Suppose, for instance, that there were two shocks originating at the same place with some seconds interval between them; each in general would give rise to compressional and distortional waves; the first kind travels faster and hence outraces the second. The compressional waves of the second shock would overtake the distortional waves of the first shock in a circular zone surrounding the origin, and as their motions are at right angles to each other, we should find parallel rotations in this

zone. Again, suppose two shocks originated at different centers, their waves, in general, would cross each other at an angle, and we might have circular or elliptical motion as a result of the combination of the two sets of compressional waves, of the two sets of distortional waves, or of each set of compressional with the other set of distortional waves. Modifications of the waves on passing from one kind of rock to another would occur and give rise to still other combinations which would cause parallel rotations.

With the hope of throwing light on the progress of the rupture along the fault-plane by determining the distribution of rotatory effects in the surrounding regions a special list of questions was sent out and many answers were received. They may be summarized as follows: at a distance, where the shock was but slightly felt, rotations were rarely noticed; but where the shock was strong, even tho many miles from the fault, they were almost universal; a number of observers stated that the disturbance was first a simple vibration, and that the rotatory motion only appeared later; no one put the rotatory motion in the early part of the shock. Some, who did not notice rotations, stated that the direction of the motion changed during the disturbance. At a distance from the fault, where the movement was slow and gentle, the rotatory effect would not be very noticeable, but that it still existed is shown by the seismogram made at Carson City, where the intensity of the shock was greatly reduced. This general distribution of parallel rotations does not show how the rupture took place on the fault, but merely confirms the idea that the disturbance at any point was due to vibrations originating in many parts of the fault-plane; and the combinations of these vibrations would cause the variations in intensity and the rotations observed. The writhing motion of the steel smokestack at Mare Island (vol. 1, p. 212) must have been the result of a double vibratory motion of the ground combined into a parallel rotation; the elastic bending of the stack would cause a much greater vibration of the top than of the bottom; this explains the whole motion without the assumption of a tilting of the ground.

In the first volume numerous examples are given of statues, monuments in cemeteries, chimneys, etc., which were rotated on their supports by the earthquake; many were turned thru an angle of 90° and some as much as 180° (vol. 1, p. 359), tho in the majority of cases the rotation was less than 20° . In the cemetery near San Rafael all except one of the rotated monuments were turned with the hands of a watch thru angles of 16° or less. Similarly, at Lakeport all the rotated chimneys were turned in the same direction (vol. 1, p. 188). This phenomenon has long been observed and occurs at the times of all violent earthquakes; it naturally suggests a rotation of the support; but, as has been seen, a more careful examination of this idea shows that it is entirely untenable; indeed, Charles Darwin long ago pointed out that if objects were turned on their supports by true rotations, the axis of each rotated object must be an axis of the rotation, which is a practical impossibility. The effort, therefore, was made to explain the rotation merely as the result of a to-and-fro vibration. What is necessary is to produce a moment around the vertical axis thru the center of gravity.

Three suggestions have been made. First: Mallet¹ suggested that the object may not bear uniformly on its support, but may only press on it in a few points, and as the pressure will in general be different at these points a moment around the center of gravity due to the frictional forces would be produced during a vibratory movement, resulting in a rotation. Altho it may be possible for small rotations to be brought about in this way, they are probably very small and unimportant; for it can easily be shown that if the frictional forces at the points of contact follow the ordinary laws of solid friction, namely, that the tangential forces are proportional to the normal pressures, then no moment around a vertical axis thro the center of gravity will be set up by the vibrations, and it is only in so far as the ordinary laws of friction are departed from that moments can be

¹ Dynamics of Earthquakes. Trans. Roy. Irish Acad. 1846, vol. XXI, pp. 51-105.

produced. For the normal pressures must be such as to produce no moment around any straight line in the plane of the points of contact and immediately under the center of gravity; otherwise, the object, when undisturbed, could not remain stationary. If now

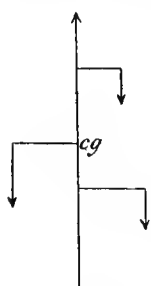

FIG. 23.

we take the straight line parallel with the direction of vibration, the moments of each frictional force about the vertical, thru the center of gravity, will be proportional to the moment of the corresponding normal force about the straight line, and therefore their sum will be zero. Houses, however, are not rigid bodies resting on rigid foundations, like a statue on its base; and the ground itself, on account of slight variations in texture or firmness, would not behave like a rigid body during the earthquake, but would have somewhat different movements at different places under the house; in this way it is quite possible for a house to be slightly rotated by the frictional forces between it and its foundation. Examples of such rotations are given in vol. 1, pp. 170, 176.

Second: Professor Thomas Gray¹ has shown that if the vibrations are at right angles to the edge of the rectangular base of a column, or along the line joining opposite corners, no rotating moment is developed; but if the shock lies between these directions, as, for example, in the direction, *of*, in fig. 24, then the column tends to rock on the corner, and to rotate around it; for the force is applied at the corner and acts in a direction parallel with the vibration and does not pass through the center of gravity. This is in entire accord with the laws of mechanics, and undoubtedly some small rotations are caused in this way; but it is to be noticed that the tendency is only to rotate until the edge is at right angles to the direction of vibration; if this direction is nearly at right angles to the edge, the rotation will be small; if the direction is nearly along the diagonal, the moment produced will be small; if the direction of vibration gradually changes, keeping pace with the turning of the column, a larger rotation might accumulate. In the case of columns with circular bases, the method would not apply at all; and it may be well doubted if any large rotations are produced in this way.

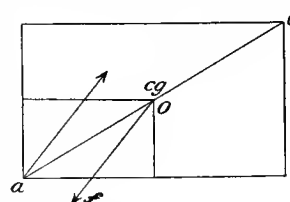

FIG. 24.

Third: The combination of vibrations at right angles offers a simpler explanation for any amount of rotation and for any form of base. If an object, as a result of the vibration, is rocking on its edge and is then subjected to a second vibration at right angles to the first, a strong moment will be set up and the object will rotate; if these vibrations are so timed as to produce parallel rotation of the support, the body will continue to rotate as long as the vibrations are sufficiently strong. One can easily realize this experimentally by means of a chair. Raise the front legs slightly from the floor by pressing against the back; then press against the side of the chair, and it will swing around about 90° on one leg; or, place a box or bottle on a book, and then rotate the book, keeping it parallel with itself; if the movement be strong enough and the friction sufficient to prevent slipping, the object will rock and rotate. The principle of cross vibrations seems to be the true explanation of the rotation in most cases and in all cases where the rotation is large. Cross vibrations will not be produced by a single shock from a single center; but a protracted shock, or successive shocks from the same center, or shocks from different centers, will produce them; that is, they will practically occur at the time of all large and important earthquakes, for then the vibrations usually originate at many points and at slightly different times.

¹ Milne, *The Earthquake in Japan of Feb. 22, 1880*. *Trans. Seism. Soc. Japan*, vol. 1, part II, pp. 33-35; and *Seismology*, p. 170.

The explanation of rotations by means of cross vibrations seems first to have been given by F. Hoffmann¹ and later repeated independently by Mallet² and others, but it does not seem to have received the consideration it deserves. I think it is clear from this chapter that cross vibrations are not only capable of explaining rotations wherever the disturbance is sufficiently strong, but that no other theory, so far proposed, can explain satisfactorily the very large rotations which statues and monuments experience.

SURFACE WAVES IN THE MEGASEISMIC DISTRICT.

In addition to the ordinary vibrations which we have been studying, many persons reported waves in the ground which had the appearance of ordinary waves on the surface of water (vol. I, pp. 380, 381). They were not a peculiarity of the California earthquake, for similar phenomena have been recorded in connection with almost all great earthquakes and have given rise to much discussion as to their cause. It is probable that they result from the modifications of condensational vibrations by the surface, as appears from the following considerations. The resistance of a substance to compression and distortion depends upon the values of two coefficients: k , the coefficient of compression under equal pressure in all directions, and n , the coefficient of rigidity or shear. If we compress a small cube of any substance between two plates, the modulus of compression, that is, the ratio of the applied forces per unit area to the linear contraction, is called Young's modulus, and its value in terms of the coefficients mentioned above is $\frac{9nk}{3k+n}$. This represents the resistance which the substance offers to compression. When the pressure is exerted, the cube is not only compressed in the direction of the pressure, but it expands at right angles to this direction, and the ratio of this expansion to the normal compression is $\frac{3k-2n}{2(3k+n)}$. The value of this ratio varies with different substances, but in general it is not far from 1:4. When the vibrations pass through the interior of the earth, the rocks are subjected to compressions and expansions, but the surrounding rock allows only longitudinal contraction or expansion and the modulus of elasticity is then given by $\frac{3k+4n}{3}$, which is greater than Young's modulus. At the surface expansion can take place upwards but not laterally, and it can be shown that here the modulus of elasticity is given by the expression $\frac{4n(3k+n)}{3k+4n}$, and the ratio of the vertical expansion to the longitudinal contraction is $\frac{3k-2n}{3k+4n}$.

The values of k and n have been determined for a number of specimens of rock by Messrs. H. Nagaoka,³ S. Kusakabe,⁴ and Adams and Coker.⁵ The average values which the last investigators found for granites are $k = 4.3 \times 10^6$ pounds per square inch, and $n = 3 \times 10^6$ pounds per square inch; and the vertical expansion would be nearly 0.3 of the longitudinal compression. As we pass down from the surface the increasing weight of overlying rock would greatly diminish the vertical expansion, and at a depth comparatively small would prevent it altogether. The actual vertical movement at the surface would be the addition of all the vertical expansions from the surface down. A longitudinal contraction of 1:8,350, as found in the example already used, would cause a vertical

¹ Nachgelassene Werke, 1838, vol. II, p. 310.

² The great Neapolitan earthquake, vol. I, pp. 375-381.

³ Elastic Constants of Rocks and the Velocity of the Seismic Waves. Publications of the Earthquake Investigation Commission in Foreign Languages, No. 4, 1900; and Phil. Mag. July, 1900, vol. L.

⁴ On the Modulus of Rigidity of Rocks. Publications of the Earthquake Investigation Commission in Foreign Languages, No. 14, 1903; No. 17, 1904; and No. 22B, 1906.

⁵ An investigation into the Elastic Constants of Rocks, etc. Carnegie Institution of Washington, Publication No. 46, 1906.

expansion of about 1 : 30,000; if we assume that the weight of the overlying rock would make the vertical expansion practically disappear at the depth of a mile; and if we assume further that the average expansion above this point is one-third of its value at the surface, we should find a vertical amplitude at the surface of 0.66 inch, or a range from crest of trough of the waves of 1.33 inches.

Referring again to the expression for the ratio of the vertical expansion to the horizontal compression we see that its value will become greater as n becomes smaller, with unity for its greatest possible value. When the waves pass from rock into alluvium or disintegrated rock, the amplitude may become distinctly larger, and since the value of n would be much less than for granite, we should expect far larger surface waves. The movement at the surface will be upwards, forwards, downwards, and backwards in the vertical plane, just like the movement in ordinary water waves. Waves of this kind must necessarily occur wherever we have longitudinal vibrations, at a great distance from the focus as well as near it, but it is only where the amplitude of the vibration is very large that the surface waves are visible to the eye; and it is, therefore, only near the focus, and generally only on alluvium that they are observed, and only in the case of very violent earthquakes. These waves must not be confused with the Rayleigh waves, in which the horizontal component of the vibration dies out at a depth of about one-eighth wavelength, and the vertical component continues to indefinite depths; whereas the waves we have just described have exactly the opposite characteristic; they are simply the surface modification of the ordinary longitudinal waves, which exist below the surface.

It is also possible that surface waves could be formed by transverse vibrations, in which the direction of motion is vertical.

Major Dutton¹ thinks that the surface waves have no relation to the elasticity of the rock. He says: "Their lengths are too small, their amplitudes too great, and their speeds of propagation too slow to be dependent upon elasticity"; but if we refer to the modulus of elasticity which holds near the surface, and upon the square root of which the velocity of transmission depends, we see that its value becomes very small as the value of n diminishes and therefore in some alluvium it is quite possible to have slow speeds and short wavelengths, and, as we have seen, large amplitudes. It is not necessary to believe that the amplitudes of surface waves are nearly as large as they appear, for it must be remembered that an observer being shaken by the strong vibrations of a violent earthquake is in a difficult position to make good observations on the phenomena about him, and particularly to distinguish between the movements which are actually taking place and those which he apparently sees, but which are really due to his own oscillations. We have many descriptions of trees and telegraph poles being swayed so violently as nearly to strike the ground, which of course is impossible, as the distortion of the earth necessary to produce this result would have caused disruptions which were not observed; and moreover, a small vibratory movement is sufficient to cause very great commotion among trees, which would naturally be referred by an observer to tiltings due to surface waves.

¹ Earthquakes, p. 144.

THE INFLUENCE OF THE FOUNDATION ON THE APPARENT INTENSITY.

THE GREATER DAMAGE ON ALLUVIUM.

Experience shows that the damage done by destructive earthquakes is much greater on alluvial soil than on solid rock. A glance at the isoseismal map No. 23 will show how well this was exemplified by the California earthquake. Probably the best example we have is the city of San Francisco itself, which is built variously on solid rock, on sand, on natural alluvium, and on "made ground." The description of the destruction done in the city (vol. I, pp. 220-245; maps, Nos. 18 and 19) shows that within its limits the character of the foundation was a far more potent factor in determining the damage done than nearness to the fault-line. This is not a question of the transmission of vibrations, for, on account of the higher elasticity of solid rock, it would transmit vibrations far better than alluvium; and indeed, as the alluvium occupies limited and comparatively shallow basins in the rock, the vibrations are always transmitted from a distance thru rock; and the question really to be answered is: How are the vibrations modified in a basin of alluvium so as to make them more destructive than without this modification? By analogy the well-known experiment of the ivory balls has been invoked to explain the fact. If the first of a row of ivory balls in contact receives a sharp blow, it transmits the shock to the next ball, but remains almost stationary itself; the shock is thus transmitted from ball to ball, and the last one, having nothing before it, flies off. It is said that the surface of alluvium having nothing above it, and having little cohesion, experiences a much stronger vibration than a rock-surface under similar circumstances. But the analogy does not seem to me a good one, for the lack of constraint of objects above the surface is the same whether we are dealing with rock or with alluvium; and it is only in so far as a lack of cohesion in the alluvium would permit its surface to be thrown into the air that a difference in the two substances might be supposed to make itself evident; but in the cases we are considering, the shock is not nearly strong enough to produce such an effect; and besides, structures built on rock are not usually firmly attached to it; they would be thrown upwards just as easily as tho they rested on alluvium, if subjected, in the two cases, to the same vibratory acceleration.

NOTE. — When a transverse wave, in which the vibrations are parallel with a free surface, is reflected from the surface, the amplitude at the surface is twice as great as that of the incident wave; the amplitude varies periodically with the distance from the surface in such a way that it equals the large surface amplitude at distances of any even number of times $\lambda/4 \cos i$; where λ is the wave-length, and i is the angle of incidence; and it is zero at distances of any odd number of times the same expression. With transverse waves not parallel with the surface or with longitudinal waves the problem is much more complicated; it would still resemble the simpler case, but the variations of intensity would be less marked. The strong surface motion would extend some distance into the medium; this is probably why observations in mines have shown practically the same intensity of movement as at the surface; the depth of the mines is only a fraction of $\lambda/4 \cos i$.

THE THEORY OF MR. ROGERS'S EXPERIMENT.

With the object of throwing light on this subject, Mr. J. F. Rogers made some very interesting experiments (vol. I, pp. 326-335), in which sand containing various amounts of water and held in a wooden box was caused to vibrate to and fro and the movement of the top of the sand compared with the movement of the box. The outside forces are

applied to the sand either at the base or at the sides of the box and must be transmitted thru the sand. What is the character of this transmission? Evidently it must depend upon the amount of water contained in the sand and also upon the frequency of the vibrations. If the sand is fairly dry and the frequency slow, the sand will act very much as an elastic solid body and we may assume that the successive horizontal layers shear slightly over each other as a solid would do, and that the forces brought into play are proportional to the shear. The movement under these conditions, when we neglect the influence of the sides of the box, would be somewhat like the movement of a flexible rod fastened to the bottom of the box. The rod, however, would be bent with compressions and expansions on opposite sides, whereas the sand is distorted simply by the elastic shear of successive horizontal layers over each other; but the character of the motion in the two cases is very similar. To understand the movements of the sand we must consider the forces acting between the successive layers. The equation of motion of such a system (provided the motion is not too large) is

$$\frac{d^2y}{dt^2} = \frac{n}{\rho} \frac{d^2y}{dx^2}$$

where x is measured vertically upwards, and y in the direction of motion; t is the time, ρ the density of the material, and n its coefficient of rigidity or shear. The solution of the equation if the column of sand were slightly distorted, and then allowed to vibrate without further disturbance, is

$$y = A \sin \frac{2\pi}{\lambda_0} x \cdot \sin \frac{2\pi}{T_0} t \quad (2)$$

where

$$\frac{\lambda_0^2}{T_0^2} = \frac{n}{\rho}$$

This represents a standing wave, of wave-length λ_0 and period T_0 . The period may have a great number of values, namely:

$$T_0 = \frac{4H}{2m+1} \sqrt{\frac{\rho}{n}} \quad (3)$$

and the corresponding wave-lengths are

$$\lambda_0 = \frac{4H}{2m+1} \quad (4)$$

where H is the thickness of the sand; and $2m+1$ is any positive, odd, whole number. Introducing these values in (2) we get

$$y = A \sin \frac{2\pi(2m+1)}{4H} x \cdot \sin \frac{2\pi(2m+1)}{4H} \sqrt{\frac{n}{\rho}} t \quad (5)$$

The longest period with which the system can vibrate is

$$T_0 = 4H \sqrt{\frac{\rho}{n}} \quad (6)$$

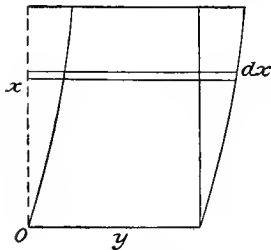

FIG. 25.

but in addition there may be superposed the odd harmonics. For the simplest vibration an originally vertical straight line would be changed into a quarter of a sine curve, as shown in fig. 25. Equation (6) is the expression used on page 39 to determine the free period of vibration of the strained rocks near the fault-plane at the time of the earthquake.

Suppose, instead of vibrating freely, the base of the sand is made to vibrate according to the expression $B \sin \left(\frac{2\pi}{P} \right) t$; *i.e.*, with an amplitude B and a period P .

The solution of equation (1) under these conditions is

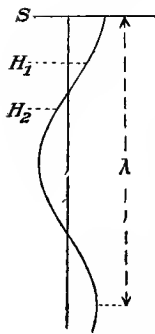

FIG. 26.

$$y = \frac{B}{\cos 2\pi \frac{H}{\lambda}} \cos \frac{2\pi}{\lambda}(x - H) \sin \frac{2\pi}{P}t \quad (7)$$

where λ , the length of a distortional wave of period P in the sand, supposed of indefinite extent, equals $P\sqrt{\frac{n}{\rho}}$. Equation (7) shows that a vertical straight line in the sand is distorted into a cosine curve with its maximum amplitude at the surface. Fig. 26 shows the form of this curve; S is the surface and only that part of the curve is followed which lies between S and the bottom at the distance H below it. At the surface $x = H$, since x is measured from the bottom, and the amplitude becomes

$$\frac{B}{\cos 2\pi \frac{H}{\lambda}} \quad (8)$$

and this varies between B and infinity, according to the value of the ratio of $\frac{H}{\lambda}$. If H is any even number of times $\frac{\lambda}{4}$, the denominator becomes 1 and the amplitude becomes B . If H is any odd number of times $\frac{\lambda}{4}$, the denominator becomes 0 and the amplitude infinite. If, instead of varying the depth, we suppose it constant and vary the period of the disturbance, we get similar results. Replace λ in (8) by its value and the surface amplitude becomes

$$\frac{B}{\cos \frac{2\pi H}{P\sqrt{\frac{n}{\rho}}}} \quad (9)$$

The free periods of the system are given by equation (3), and if P has one of the values there given, the denominator of (9) becomes the cosine of an odd number of times $\frac{\pi}{2}$, which is 0, and the amplitude becomes infinite. Practically, of course, friction or a slipping of the sand particles would prevent the amplitude from becoming extraordinarily large.

We see, therefore, from (7), (8), and (9) that the surface would vibrate with the same period as the base and that it would always be in the same or in the opposite phase; that its amplitude would never be less than that of the base and that it would in general be larger and might become indefinitely large when the depth of the sand is an odd number of times a quarter wave-length, a wave-length being determined by the density and rigidity of the mass and the period of vibration; or what amounts to the same thing, when the period of vibration becomes equal to one of the free periods of the system. If, however, the frequency of the vibration should be too great, the bond between the different grains of sand would be broken, and the conditions upon which the above conclusions are based would no longer hold; the sand grains would slip over each other, and the amplitude of the upper surface would be diminished. If we apply the above theory to Mr. Rogers's experiments with dry sand, we find it in close agreement with his results. When the frequency is very low, the sand moves with the box; in terms of the theory, we are dealing with only the upper part of the curve in fig. 26, and since H is very small in comparison with λ the surface amplitude as given by (8) becomes B , the amplitude of

the base. As the frequency increases the wave-length, λ , decreases, and the surface amplitude increases; we have to do with a longer part of the curve in fig. 26. When the frequency becomes too large, the surface amplitude begins to decrease, suggesting that the sand no longer acts as a solid, but that slipping takes place. The addition of a small amount of water to the sand diminishes the cohesion between the grains, which reduces the value of the coefficient of rigidity, n , and shortens the wave-length, for a given frequency; we therefore get larger surface amplitudes, but slipping occurs at lower frequencies than with drier sand. As the sand is probably only able to bear a definite shearing force without slipping, an increase in the amplitude of vibration would cause the slipping to begin at a lower frequency than with smaller amplitudes. The conclusions are in good accord with Mr. Rogers's results as shown graphically in his figs. 62 and 63.

When, with increasing frequency, the slipping first begins, it must take place only at the ends of the strokes where the acceleration, and therefore the force, is greatest; but as the frequency gets still higher, the slipping is spread over a greater and greater part of the stroke and the surface amplitude becomes less and less; the mathematical theory we have sketcht out does not apply after slipping begins.

So far we have considered the motion as communicated to the sand from the bottom of the box and not by the pressure of the sides, which would undoubtedly modify it, but the results given by Mr. Rogers are for the sand near the middle of the box where the sides have the least influence; and in one experiment where the sand was piled up on the bottom of the car without touching the sides, the results were not altered; it appears therefore that in the case of sand which is not too wet, and for frequencies not high enough to cause slipping, the influence of the sides has not been great enough to alter the general character of the motion of the sand in the middle of the box; but near the sides their influence causes much confusion in the motion of the sand.

When the sand is thoroly soaked with water, it becomes very plastic, the elastic forces become very small and viscous forces become the predominating forces between the successive layers. We therefore determine what is the character of the motion transmitted from the bottom by means of viscous forces. We find that transverse waves are set up which advance to the surface and are there reflected back again. These waves have a wave-length dependent upon the density of the material and the viscosity, and are very quickly damped out. Indeed, the amplitude of the advancing wave is reduced to less than 1/500 of its original value at a distance of one wave-length from the base, and the reflected wave starts with a small amplitude and dies out very rapidly. We find that the amplitude at the surface is always less than that at the base and that its value is twice as great as that of the direct wave at the surface if it were not reflected; that is, if the depth of the sand were one wave-length the amplitude at the surface would be about 1/250 of the amplitude at the base, instead of about 1/500, as in the case of no reflected wave. It is quite evident that waves of this character could not explain the movement of the wet sand in the experiment; and we therefore turn our attention to the influence the sides of the box would have on the motion of a fluid as viscous as the mixture must be. As Mr. Rogers says, the damping is so great that the mixture could not have a free period of its own. The experiment described in vol. I, pp. 328 and 329, and illustrated by fig. 61, shows very well the character of the motion, namely, that the surface material moves very steadily during the greater part of its excursion with a fairly uniform velocity, somewhat greater than that of the base, and that its velocity is rapidly reversed at the end of the stroke. This being the case we conclude that there is little force acting upon the sand except near the ends of its excursion and that there a strong force acts for a short time. It seems probable, therefore, that as the box diminishes in velocity towards the end of the stroke the sand, by its inertia, is carried forward and raises the mixture in

front of it against the side of the box; this together with the return movement of the box produces a strong force which quickly reverses the movement of the sand, giving it a velocity slightly greater than the maximum velocity of the box; but the force is not active again until the box approaches its maximum displacement on the other side. The movement therefore depends upon the action of the sides of the box and is not transmitted from the bottom. It is clear from Mr. Rogers's experiments that the forces when the sand is dry are very different from those when the sand is very wet; and when different parts of the sand contain different amounts of water, that the movements would be so different as to produce much confusion.

APPLICATION OF THE THEORY TO SMALL BASINS.

When we attempt to apply the results of the experiments to explain the case of the greater disturbance in alluvial soil than in rock, we recognize with Mr. Rogers that it is dangerous to carry analogy from such small quantities to such large masses, and we must be very carefully guided by theory if we wish to avoid great error.

As already noted, alluvium occupies basins in the rock of more or less extent, and in considering its motions we must divide the basins into two classes; the first comprises those basins which are small enough, in the direction of propagation, for all parts to move practically in the same phase, like the box in Mr. Rogers's experiments; that is, they must be not much larger than an eighth of the wave-length of the waves in the surrounding rock. With waves whose period is as short as a half second, the basins may be somewhat more than a quarter mile across; but with periods as long as 10 seconds, they may be over 5 miles across, and still be in this class. The second class comprizes all large basins, where the progressive character of the wave-motion must be considered.

Where alluvial basins are not extremely small, they are always much broader than they are deep, usually many times as much; and they are also saturated with water. When the material is largely sand or gravel, the grains are held so closely together by the weight of the material lying above them that the vibrations can be transmitted from the bottom in the same way as with dry sand; but when the material is soft mud, transverse vibrations can not be so transmitted and the influence on the sides becomes predominant. The limiting case of fluidity is exemplified by streams, ponds, and even vessels containing water or milk, where the liquid may be so greatly agitated as to be splashed out on the sides. Mr. Rogers's experiments seem to explain pretty satisfactorily the larger surface amplitude and the greater damage done in the class of small basins of alluvium; but it must be noted that the basins have not a flat bottom like a box, but have rather an open V shape, like stream valleys; and there is no abrupt distinction between the bottom and the sides. Where the material is sufficiently solid, the vibrations are transmitted both as transverse and longitudinal vibrations from the bottom, the surface amplitude being in general greater than at the base and varying with the depth, the coefficient of rigidity, and the period of the vibration; the depth of a basin is more or less irregular, the character of the material, and therefore the coefficient of rigidity, varies from point to point; therefore the amplitude will vary from point to point on the surface, and points not far apart may be even in opposite phases, so that more or less discordant movements take place. The commotion may be sufficiently great to produce cracks in the ground, especially at the boundaries of softer and firmer material. The damage to buildings is due more to the discordant character of the disturbance than to the mere increase in amplitude at the surface of the alluvium, for deep pilings with a strong concrete capping diminish the damage to a remarkable degree; the capping must move nearly as a rigid body and relieve the building above it from different movements in different parts of its foundation. The capping must also diminish the amplitude, for movements in opposite direc-

tions of neighboring parts of the alluvium would be nullified by it. When the alluvium is so soft and plastic that shearing forces are insignificant, the alluvium is flung back and forth by the reaction of the sides of the basin with effects apparently still worse than in the former case; and with the formation, near the sides, of elevations and depressions resembling wave-surfaces; but they are not true progressive waves, for the rigidity is too small for the surface waves described on page 47 to be formed; and the viscosity is too great to permit of gravitational waves, but the violent to-and-fro motion of the basin and the low rigidity produce, near the sides, elevations resembling a wave surface, and the motion of the soft alluvium is so quickly damped out by its viscosity that the form is fixt and remains after the disturbance is over. This condition was characteristic of the small filled-in swamps of San Francisco, usually accompanied by a general lowering of the surface, due to the character of the refuse used for filling them; this material was so little consolidated that the surface has been steadily sinking for years (vol. 1, pp. 241-242), and its volume was materially reduced by the shaking of the earthquake.

LARGE BASINS.

The second class of alluvial basins are those which are too large to be lookt upon as moving as a whole; that is, they are larger than an eighth wave-length; in some cases they are many wave-lengths in breadth. They are represented in California by the large valleys, the Santa Clara, the San Joaquin, etc. We must picture them to ourselves as broad, shallow basins with irregular floors and containing material whose coefficient of rigidity varies considerably even in neighboring parts; this material is principally water-soaked sands and gravels, given a certain amount of rigidity by the weight of the material above it. As the elastic waves pass thru the underlying rock they enter the alluvium and are refracted upwards on account of the smaller velocity in the alluvium than in the rock. If the angle of incidence is sufficiently small, the amplitude of vibration in the alluvium will be larger than in the rock; for instance, if we assume the density of the alluvium to be 0.8 that of the rock, and the velocity of propagation one-fifth as great, then for normal incidence the amplitude of the refracted wave in the alluvium would be nearly double that of the incident wave in the rock, both for compressional and for distortional waves. After entering the alluvium the waves would be reflected back and forth from the surface and bottom until they were damped out by the viscosity of the alluvium; for normal incidence the amplitude of the wave reflected from the bottom would be fifteen-sixteenths that of the incident wave, and then a large part of the motion would be kept in the alluvium. When the angle of incidence from the rock to the alluvium is greater than zero, two reflected and two refracted waves are produced; and when this angle is not large the refracted wave in the alluvium would still have a larger amplitude than the incident wave in the rock. When reflected at the surface, the wave would have its phase changed by half a period, and if the length of its path to the floor and back again were a half wave-length, it would find itself in the same phase as the direct wave when it again reached the surface, and the resulting amplitude would be the sum of the amplitudes of the two waves. In many parts of the basins this relation of depth to wave-length must approximately have existed for some of the waves present in the earthquake disturbance. Repeated reflections would probably result in a surface amplitude considerably greater than would occur at the surface of continuous rock; and the irregularities mentioned above would cause discordance of motion in points near together, and thus greatly increase the damage.

A thin coating of alluvium over the rock would evidently move with the rock and would not have an especially large amplitude; it would be necessary for its depth to be something like an eighth of a wave-length to obtain the full effect; the small velocities

of transmission in alluvium would allow this condition to be satisfied even with a much smaller depth than was found in many parts of the large Californian valleys.

Surface waves would also be a strong factor in causing damage on alluvium; these waves and the irregularities due to varying coefficients of elasticity are probably the principal causes of the increased damage on alluvial soils, even when of sufficient thickness to experience the accumulated amplitudes described above.

The sides of the basins would exert no special influence except in their immediate neighborhood; but a certain amount of irregular reflection and refraction there would probably cause unusual intensity at some points.

THE FOUNDATION COEFFICIENT.

At Professor Lawson's suggestion I have attempted to find some quantitative relation between the intensity of the shock on sands, marshy land, and solid rock.

We shall first consider small basins within the limits of San Francisco. If we look at the profiles drawn by Mr. Wood and reproduced in map 18, we find the following estimates of the accelerations (a column has been added to the table giving the ratios of the accelerations on the various materials to that on the most solid rock. I have called this ratio the *foundation coefficient*):

TABLE 4.—The Foundation Coefficient (San Francisco).

SECTION.	FOUNDATION.	ACCELERATION mm. / sec. ²	FOUNDATION COEFFICIENT.
E F	Serpentine	250	1.0
E F	Made land	1,100	4.4
E F	{ Marsh	3,000	12.0
	{ Sandstone	250 to 600	1 to 2.4
C D	Made land	2,900	11.6
C D	Sand	600	2.4
C D	Sandstone	400	1.6
A B	Sand (Mission Valley)	1,100	4.4
A B	Marsh	3,000	12.0
A B	Sundry solid rocks	250	1.0

These observations are not all entirely independent; for instance, the marsh indicated in the first and last sections is the same marsh, as these two sections go thru it; and the first two sections cross on the sandstone of Telegraph Hill. The high intensity at the southwestern extremity of section *AB* has not been considered because it is too near the fault; nor has the local strengthening of the intensity near the middle of section *CD*, which apparently is not to be explained merely by the nature of the terrane at these points. The very low intensity of only 250 millimeters per second per second on solid rock indicates a smaller intensity in San Francisco than further north, where we should have to go at least three times as far from the fault-line to find the intensity so low. The table, which gives only a very rough approximation to the coefficients, shows that the damage on small marshes may represent an acceleration as much as 12 times as great as on solid rock; on made land, from 4.4 to 11.6 times as great; on loose sand, from 2.4 to 4.4; and on sandstone, from 1 to 2.4. Altho it has been well known that the apparent acceleration on soft land is much greater than on rock, the ratios obtained seem very much greater than had been suspected.

The following table gives a list of places on alluvial soil in basins of considerable size, too large to be considered *small* basins, in the sense we have used that word.

TABLE 5.—*The Foundation Coefficient (Distant Points).*

PLACE.	ROSSI-FOREL SCALE.		ABSOLUTE SCALE.		FOUNDATION COEFFICIENT.
	Apparent Intensity.	General Intensity.	Apparent Intensity.	General Intensity.	
Salinas	IX	IV +	2,000	125	16
San Jose	IX	VII ?	2,000	300	7
Santa Rosa	X	VIII	2,500	1,200	2
Ukiah	VIII	VII	1,200	250	5
Willits	IX	VII	2,000	250	8
Clear Lake	VIII	VI	1,200	200	6
Priest Valley	VII	IV $\frac{1}{2}$	300	100	3
Sacramento	VI $\frac{1}{2}$	V $\frac{1}{2}$	200	125	2
Los Banos	IX	V $\frac{1}{2}$	200	125	16
West San Joaquin Valley	VIII +	V $\frac{1}{2}$	1,600	125	12

The intensities are given both in the Rossi-Forel scale and in the absolute scale of accelerations; the first column under each scale gives the *apparent* or felt intensity, and the second gives the *general* intensity or what seemingly would have been felt on solid rock if it had existed there. To determine the general intensity requires the exercise of some judgment, guided of course by the intensity map, No. 23; this quantity therefore is subject to considerable error. The same is true of the values in the absolute scale; we have used Professor Omori's estimates of the absolute values of the Rossi-Forel scale for intensities of VII or more¹ and Professor Holden's estimates for the lower intensities.² The difficulties of obtaining the correct intensities, apparent and general, according to the Rossi-Forel scale, and the further difficulty of translating into the absolute scale, on account of the larger difference between the successive degrees of higher numbers of the former scale, make the values obtained only approximate; therefore it must be recognized that the foundation coefficients are far from accurate.

The regions about Sacramento, Santa Rosa, and Priest Valley seem to have had their intensities increased least of all the alluvial basins. The great destruction of Santa Rosa suggested a special disturbance in that region, but this seems entirely unnecessary in view of its low coefficient in the table. The Salinas and San Joaquin Valleys have exceptionally high coefficients. The value at Salinas is probably accounted for by the extremely loose character of the alluvium in the flood-plain of the river and its nearness to the fault; but the low value at Sacramento suggests that a similar explanation may not be satisfactory for Los Banos and the San Joaquin Valley; and the high intensity the whole length of this valley has suggested an auxiliary fault in the region. The fact that the greatest northeastern extension of the lower isoseismals is not opposite the center of the known fault, but almost opposite its southern end; and the extension of the same isoseismals to the southeast, where they are more nearly symmetrical with respect to the San Joaquin Valley than with respect to the known fault, support the view of an auxiliary fault in or near this valley. On the other hand, it is quite possible that the intensity in the valley has been overestimated, and that the alluvial character of the ground may account for the intensity that actually existed there. I am inclined to think an auxiliary crack the best explanation of the high intensity in the San Joaquin Valley; but the evidence for it is by no means satisfactory. (See further, vol. 1, pp. 344, 345.)

The great differences in the coefficients found for the different alluvial basins are much too great to be accounted for by inaccuracies in their determinations; we must conclude that there are differences in the character and in the depth of the alluvium in different basins, and probably even in different parts of the same basin, which are important factors in the values of the coefficients.

¹ Publications of the Earthquake Investigation Commission in Foreign Languages, No. 4.

² Dutton's Earthquakes, p. 128.

PART II

INSTRUMENTAL RECORDS OF THE EARTHQUAKE

EARTHQUAKE INVESTIGATION COMMISSION

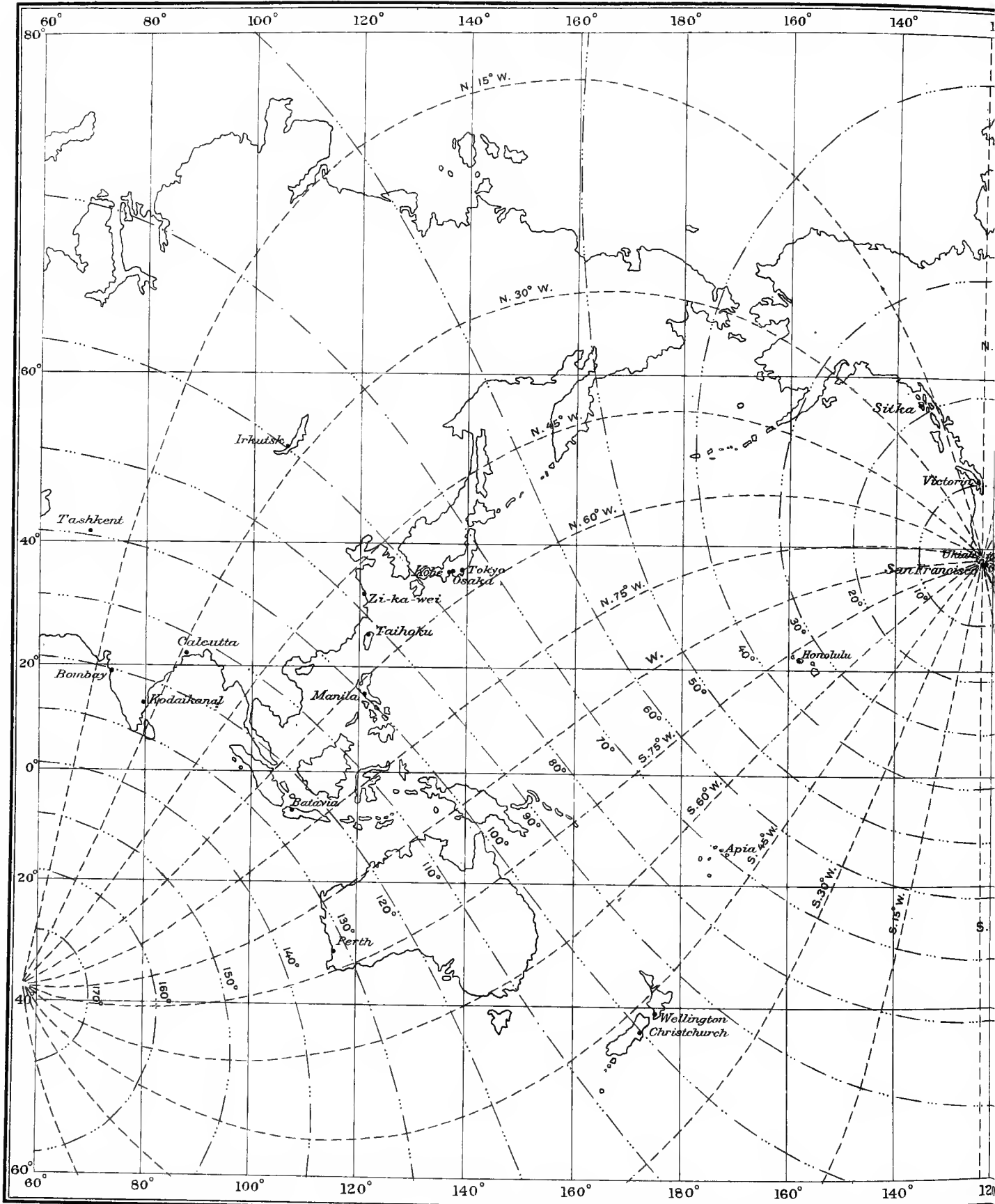

MAP SHOWING DISTANCES AND DIRECTI...

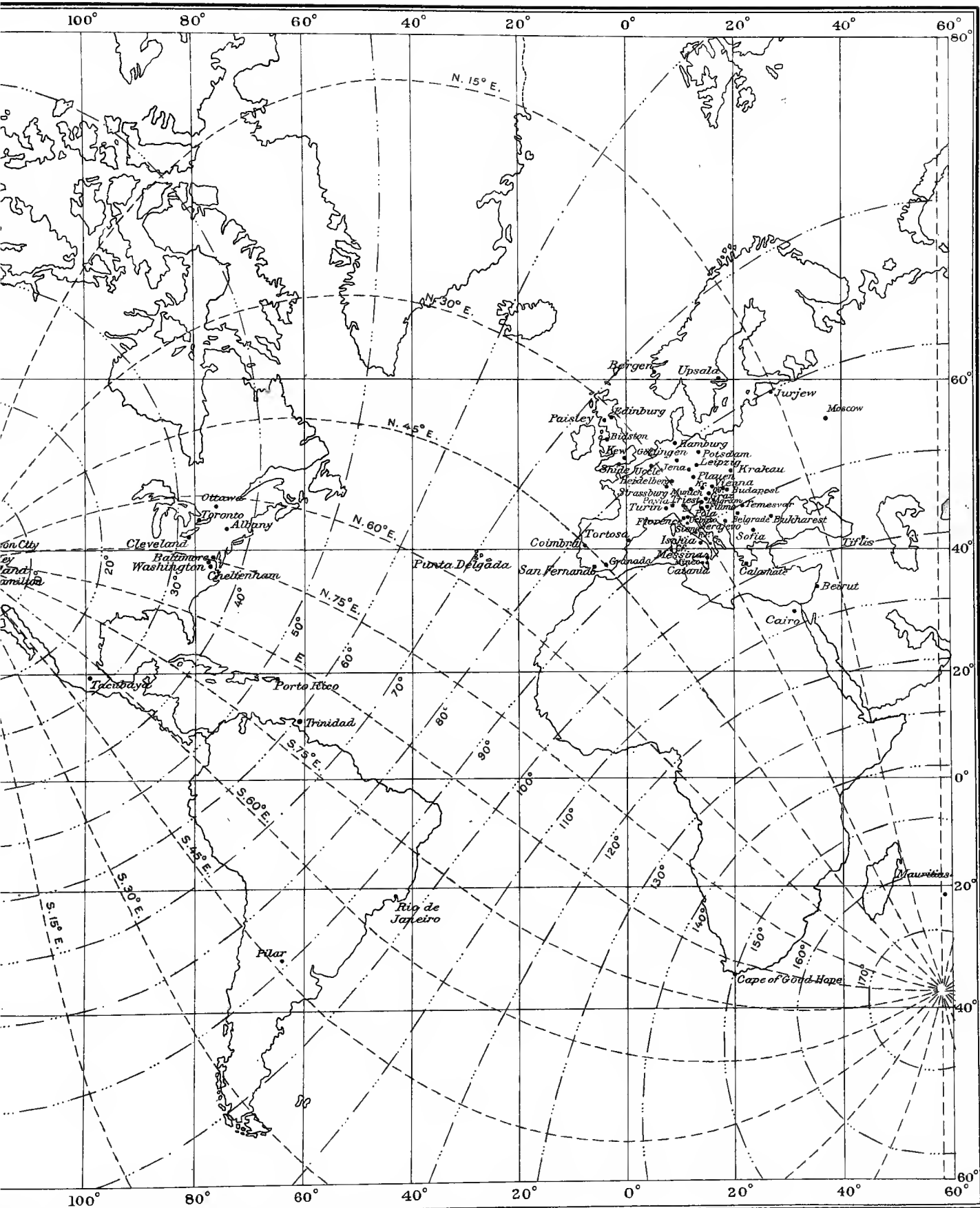

ISOSEISMALS FROM THE ORIGIN OF THE SHOCK

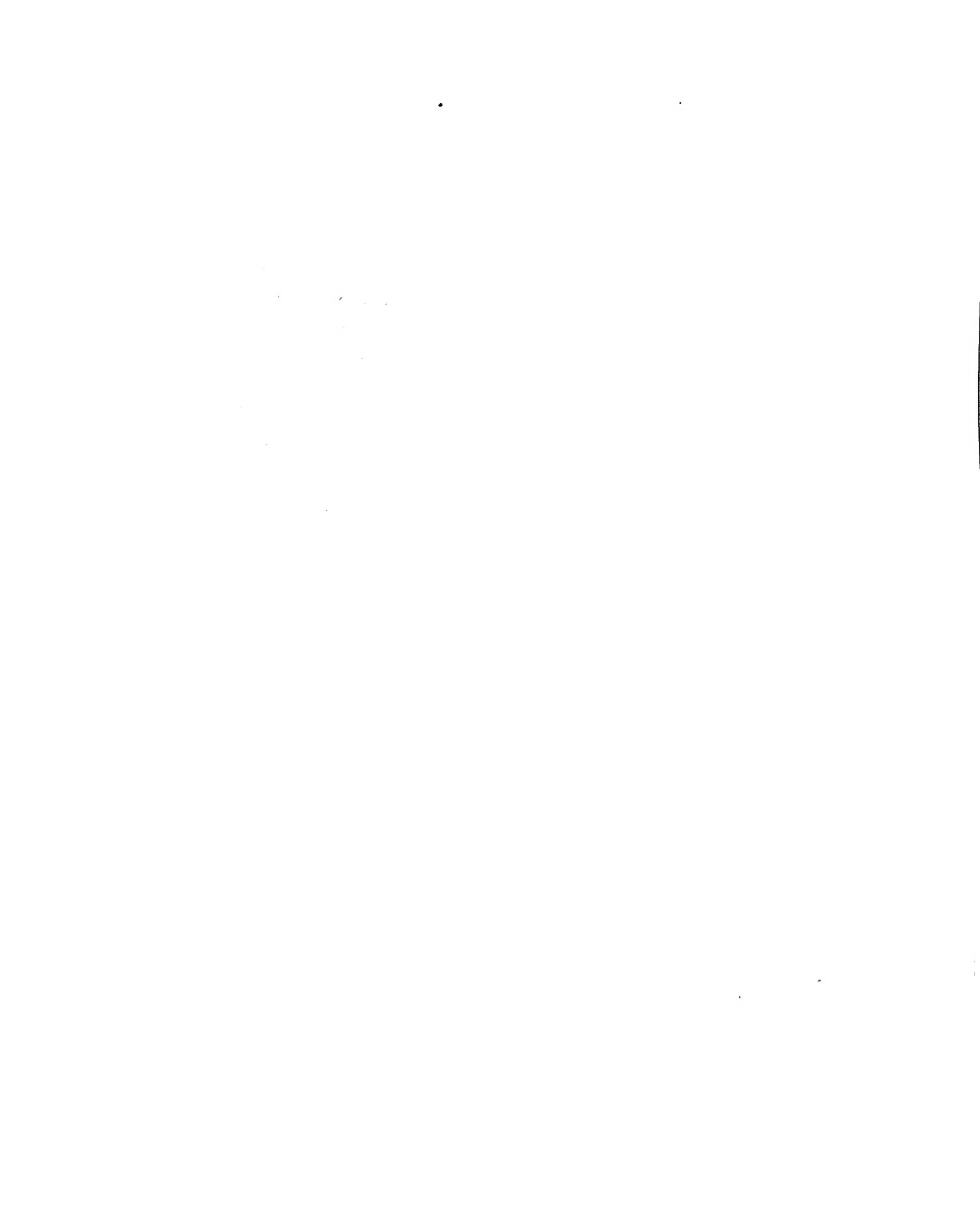

COLLECTION AND REPRODUCTION OF THE SEISMOGRAMS.

The intensity of the shock was so great that practically all seismographs, situated in any part of the world, recorded it. Shortly after the earthquake letters were addressed to all the seismological observatories in the world asking for copies of their seismograms and other necessary data, and the Commission takes pleasure in expressing its thanks to the directors of the various observatories, who were kind enough to send reports and either their original seismograms or copies, which have been reproduced in the Atlas. A few, however, were too faint for reproduction and have been omitted.

In the great majority of cases, copies of the seismograms, and not the originals, were sent; and it was not thought necessary to reproduce them in facsimile, especially as the International Seismological Association has recently reproduced in facsimile the seismograms of the Valparaiso and Aleutian earthquakes of August 16, 1906. A very careful tracing was therefore made of each seismogram and this was reproduced by photolithography. Some of the seismograms, especially those made by Milne instruments, do not lend themselves to this method, and they have been reproduced by a gelatin process. Some of these were too faint in places to yield good reproductions; they were accordingly slightly strengthened, the draftsman keeping well in view the character of the instrument and being guided by the marginal records, so that the true form of the central record has been preserved.

Great care has been given to all reproductions, and the characteristics of the various seismograms have been well brought out.

In printing the seismograms those recording times are so placed that the time increases from left to right; it has not always been possible also to make the time increase from top to bottom, but an arrow has been placed at the beginning of the record so that this part can readily be found. In most cases the times are given in Greenwich mean civil time (G. M. T.), 0 hours beginning at midnight. Where a correction is necessary or where local time is used, the correction to reduce to G. M. T. is given under the seismogram, the total correction is always given, including the error of the clock, the parallax of the recording stylus, and the correction for longitude where local time was used.

The seismograms are reproduced in their original size, except in a few instances, which are noted. These were cases in which they were extremely large and the copies supplied were from hand tracings, so that nothing was lost by the reduction; or cases in which the copies were already reduced. The seismograms on sheets 1 and 2 have been inadvertently reduced about 2 per cent; but this is unimportant. It was desired to arrange the seismograms in the order of their distances from the origin, but on account of the two different methods of reproduction, and the greater number of plates this plan would require, it was given up and the seismograms arranged so as to make the smallest possible number of plates. The seismograms from any station can readily be found from the list of observatories, from the contents, or from the table of contents of the Atlas.

OBSERVATORIES AND THE DATA OBTAINED.

In the following list the observatories are arranged in the order of their distances from the origin of the disturbance, and the map, plate 1, shows their positions graphically; it also shows their distances from the origin and the courses followed by the earthquake waves.¹ The distances of the stations are calculated along the arc in degrees and in kilometers, and along the chord in kilometers. In calculating these quantities the ordinary trigonometrical formulæ are used. The earth is considered spherical with a radius of 6,370 km.; which gives 111.18 km. for the length of one degree of arc. (We can readily convert kilometers into miles by multiplying by 1.61.) In the collection of data all information available aiding in the interpretation of the seismograms is given. Altho other instruments in the same observatory may have recorded the shock, only those whose records were obtained are mentioned; and all their constants, so far as possible, are given. The component indicated refers to the direction of the earth vibrations recorded; for instance, a horizontal pendulum in the meridian would record the east-west component. The abbreviations used have the following meanings:

- T_0 , the complete period of the pendulum without damping.
- V , the magnifying power for very rapid vibration.
- J , the indicator length, as used by Professor Wiechert. It is the product of the length of the simple mathematical pendulum, having the same period, multiplied by the magnifying power, V . Its value is therefore $(T_0/2\pi)^2 g V$. It is also given by a/ω , where a is the displacement of the pointer due to a tilt, ω , of the ground. On account of friction these two values do not always agree. The value obtained by the first method is given; and *Angular displacement* gives the displacement of the pointer due to a tilt.
- L , the distance of the center of oscillation from the axis of rotation; it equals the length of a mathematical pendulum of the *same type*, as defined on page 155.
- L' , the length of the simple mathematical pendulum having the same period. Its value in meters is practically the square of half the period in seconds.
- M , the mass of the pendulum.
- ϵ , the damping ratio of the vibrations.
- r , the frictional displacement of the medial line, as defined on page 163, and shown in fig. 43.

In the majority of cases the values of the constants, or data sufficient to calculate them, have been supplied by the director in charge of the instrument; in the case of the Milne or the 10-kilogram Bosch-Omori instrument, the values of some of the constants could be obtained from exactly similar instruments installed in Baltimore. The value of L for the Wiechert inverted pendulum is taken from Dr. Etzold's report on the Leipzig instrument. The times of the arrival of the different components at the station as recorded by the various instruments refer to the *first preliminary tremors*, the *second preliminary tremors*, the *regular waves*, the *principal part*, and the *maximum disturbance*. The hour is usually omitted as unnecessary; when the times are reported in minutes and seconds, they are indicated thus, 21^m 43^s; when they are reported in minutes and tenths of minutes they are indicated thus, 21.7^m. The *interval* of time required for the waves to reach the station is given by subtracting the time of the shock, 12^m 28^s or 12.5^m, from the time of arrival. The *amplitude* is the displacement of the pointer from its position of equilibrium measured on the seismogram in millimeters, and always refers to the maximum disturbance unless it stands opposite some other time. The *earth's amplitude* is the corre-

¹ ERRATA. — Two of the stations have been slightly misplaced. Kodaikanal, Madras, should be about 2.5 mm. north of the southern end of India and about equally distant from the sea to the east and west. Mauritius should lie in the southeastern angle between the line marking 20° S. latitude and the red north-south line thru the antipodes of the origin, and practically touching these lines.

sponding displacement of the earth. The *period* relates to the period of the earth-waves as recorded on the seismogram, and not to the natural period of the pendulum. Some of the times and other quantities relating to the records were sent by the directors of the various observatories, some were extracted directly from the seismograms. A discussion of any special characteristics which a seismogram may have follows the records of each station.

Usually different instruments at the same station give somewhat different times for the arrival of the various phases. The cause of these differences is not known and the average has been taken as the record of the station. In a few cases some instruments have evidently been late in responding to the disturbance; their records have been disregarded.

The *direction* of a station is the angle at the origin between the meridian and the great circle passing thru the origin and the station.

In order more readily to find the data of any particular station the following alphabetical list refers to the records and the seismograms.

List of Observatories.

STATION.	PAGE.	SEISMOGRAM, SHEET NO.	STATION.	PAGE.	SEISMOGRAM, SHEET NO.
Agram (Zagreb), Hungary . . .	93	...	Messina, Italy	100	12
Alameda, California	63	3	Mizusawa, Japan	73	...
Albany, New York	71	8	Moscow, Russia	84	...
Apia, Samoa	72	...	Mount Hamilton, California . . .	64	3
Baltimore, Maryland	71	1	Munich, Germany	85	5
Batavia, Java	106	15	Oakland, California	62	3
Belgrade, Servia	97	...	O'Gyalla, Hungary	91	...
Bergen, Norway	74	...	Osaka, Japan	76	15
Berkeley, California	62	3	Ottawa, Canada	69	10
Bidston, England	75	1	Paisley, Scotland	73	1
Bombay, India	105	2, 15	Pavia, Italy	88	7
Budapest, Hungary	91	...	Perth, Western Australia	106	2
Caggiano (Salerno), Italy	99	...	Pilar (Cordoba), Argentina . . .	95	1
Cairo (Helwan), Egypt	104	1	Pola, Austria	94	...
Calamata, Greece	102	15	Ponta Delgada, Azores	73	1
Calcutta, India	105	1	Porto Rico (Vieques)	71	8
Cape of Good Hope, Africa	107	1	Potsdam, Germany	81	4, 5
Carloforte, Sardinia, Italy	97	..	Quarto-Castello (Florence), Italy	94	6
Carson City, Nevada	65	3	Rio de Janeiro, Brazil	101	...
Catania, Italy	101	13	Rocca di Papa, Italy	96	14
Cheltenham, Maryland	70	8	Salò, Italy	89	...
Christchurch, New Zealand	103	...	San Fernando, Spain	85	1
Cleveland, Ohio	68	3	San Jose, California	63	3
Coimbra, Portugal	82	1	Sarajevo, Bosnia	97	15
Dorpat (Jurjew), Russia	78	10	Shide, England	76	7, 12
Edinburgh, Scotland	74	1	Sitka, Alaska	66	11
Fiume, Hungary	92	...	Sofia, Bulgaria	100	13
Florence (Ximeniano), Italy	93	6	Strassburg, Germany	84	14
Florence (Quarto-Castello), Italy	94	6	Tacubaya, D. F., Mexico	67	9
Göttingen, Germany	81	12	Tadotsu, Japan	104	...
Granada, Spain	87	14	Taihoku, Formosa	99	15
Hamburg, Germany	78	...	Taschkent, Turkestan	102	2, 13
Honolulu, Hawaiian Islands	68	2	Tiflis, Russia	102	...
Irkutsk, Siberia	79	2, 2a, 13	Tokyo, Japan	74	11
Ischia (Grande Sentinella), Italy	98	7	Toronto, Canada	68	1
Ischia (Porto d'Ischia), Italy	98	7	Tortosa, Spain	86	...
Jena, Germany	83	11	Triest, Austria	90	...
Jurjew (Dorpat), Russia	78	10	Trinidad, West Indies	72	...
Kew, England	77	1	Uccle, Belgium	78	2a
Kobe, Japan	77	5	Upsala, Sweden	75	9
Kodaikanal, India	106	2	Urbino, Italy	95	...
Krakau, Austria	87	13	Victoria, British Columbia . . .	66	1
Kremsmünster, Austria	86	2	Vienna, Austria	89	9
Laibach, Austria	90	...	Washington, District of Columbia	69	8
Leipzig, Germany	82	...	Wellington, New Zealand	102	2
Los Gatos, California	64	3	Yountville, California	62	3
Manila, Philippine Islands	103	4	Zagreb (Agram), Hungary	93	...
Mauritius	107	2	Zi-ka-wei, China	95	15

BERKELEY, CALIFORNIA.

Students' Astronomical Observatory of the University of California. Prof. A. O. Leuschner, director.
 Lat. $37^{\circ} 53' N.$; long. $122^{\circ} 16' W.$; altitude, 97 meters; distance, 0.46° or 51 km.; direction, S. $68^{\circ} E.$
 Foundation, solid rock.
 Seismograms, sheet No. 3.

The instruments used were (1) Ewing three-component seismograph, (2) Ewing duplex pendulum, *V*, 4. The recording plate of the three-component seismograph was raised off its bearings and failed to revolve, and the brackets recording horizontal motion were so disarranged that no reliable record was made; but the weight recording vertical motion showed a maximum displacement just within the range of the instrument, namely, 76 mm., and as the magnifying power was 1.7, and the friction so great that it was practically dead-beat, we may fairly conclude that the maximum vertical range of the ground was about 45 mm., and the amplitude half as much.

The duplex pendulum record is greatly confused and much affected by the stops which limit the displacement of the pendulum; but by a careful study of a greatly magnified record, Professor Leuschner has succeeded in working out the early part of the motion which is reproduced separately on the left of the complete seismogram. The directions on the seismograms show the directions of the earth's movements. As the magnifying power is 4, we see that there was first a movement of the earth of 4.5 mm. towards the east, that is, away from the origin, followed by a movement of 6.5 mm. to the north. It then swung towards the west and back to the southeast. The character of the movement from this point can be more easily understood from the seismogram than from a verbal description; it is soon lost in the confused record which shows a great deal of irregularity; this must, however, partly be due to the influence of the stops which limit the movements of the pendulum. The stops limited the motion so that an earth-amplitude of only 11 mm. was recorded, far less than was actually experienced.

OAKLAND, CALIFORNIA.

Chabot Observatory. Prof. Charles Burckhalter, director.
 Lat. $37^{\circ} 48' N.$; long. $122^{\circ} 17' W.$; altitude, $4 \pm$ meters; distance, 0.48° or 53 km.; direction, S. $59^{\circ} E.$
 Foundation, alluvium.
 Seismograms, sheet No. 3.

The instrument used was a Ewing duplex pendulum, *V*, 4. The seismogram is too confused to give details; but we see clearly that the movement of the pendulum was limited by the nature of the instrument; the movement seems to have been in nearly all directions, and more or less irregular, tho this irregularity was undoubtedly in part due to the pendulum's striking against the side of the case. The beginning of the movement can not be made out on the seismogram. The earth-amplitude recorded is only 10 mm., much less than was actually experienced.

YOUNTVILLE, CALIFORNIA.

Veterans' Home. F. M. Clarke, superintendent.
 Lat. $38^{\circ} 24' N.$; long. $122^{\circ} 22' W.$; altitude, 50 meters; distance, 0.49° or 54 km.; direction, N. $45^{\circ} E.$
 Foundation, alluvium over trachite.
 Seismograms, sheet No. 3.

The instrument used was a simple pendulum about a meter long, the bob weighing 8.15 kg. A long pin passes freely thru a vertical hole in the middle of the bob and records on smoked glass below, with very little friction. $V, 1.1 \pm$.

The reproduced seismogram represents the record as it was made by the pendulum. If the pendulum had remained stationary, the movements of the earth would have been just opposite to the recorded movements of the pendulum; but the record is complicated by the free swinging of the pendulum, which was subjected to little friction. The beginning of the movement can not be determined from the seismogram; but from observation of a swinging electric light Mr. Clarke reports it as north to south. The seismogram shows a movement in the northwest-southeast quadrants with a fairly uniform amplitude of 25 mm. The direction of the pendulum's swing changes, but shows little rotatory motion. Singularly, there is no large motion in the northeast-southwest quadrants, the motion in this direction being represented by an elliptic swing with its long axis directed to the northeast, but with only one-third the amplitude of the larger motion. The smallness of the friction, and the lack of exact information regarding the period of the waves, make it impossible to determine the true amount of the earth's motion.

Mr. Clarke gives the following account of the disturbance:

"The first motion was a tremor that swiftly increased in intensity from north to south, and was quickly compounded into a twisting motion accompanied with severe upward thrusts, a 'churning motion.' Then followed a jerky easterly and westerly motion, without the upward thrust, and again the twist; at the end the motion seemed to be southeasterly and northwesterly. Houses were jerked upward. Chimneys were thrown down at the latter part of the shock."

It is curious that the pendulum did not indicate more clearly the existence of rotatory motion; and it is still more curious that there was so little motion in a northeasterly direction, the direction of propagation of the disturbance.

ALAMEDA, CALIFORNIA.

Mills College Observatory. Prof. Josiah Keep, director.

Lat. $37^{\circ} 47' N.$; long. $122^{\circ} 11' W.$; distance, 0.55° or 61 km.; direction, S. $61^{\circ} E.$
Seismograms, sheet No. 3.

The instrument used was a Ewing duplex pendulum; mechanical registration on smoked glass; $V, 4.$

The seismogram shows a confused record with the beginning undetermined. The marking point has jumped and must have been caught beyond the glass plate, as the record is evidently incomplete. The recorded amplitude corresponds to an earth-amplitude of 10 mm., but it must have been much greater.

SAN JOSE, CALIFORNIA.

University of the Pacific. Prof. J. Culver Hartzell.

Lat. $37^{\circ} 20' \pm N.$; long. $121^{\circ} 55' \pm W.$; altitude, $25 \pm$ meters; distance, 1.01° or 112 km.; direction, S. $45^{\circ} E.$

Foundation, alluvium.

Seismograms, sheet No. 3.

The instrument used was a Ewing duplex pendulum, $V, 4.$

The beginning of the movement is probably contained in the blur near "W," but it is impossible to determine in what direction the pointer moved from this spot; the pointer must have caught, for the seismogram evidently represents but a small part of the disturbance. The recorded amplitude corresponds to an earth-amplitude of 10 mm.; but it must have been much greater.

LOS GATOS, CALIFORNIA.

Private observatory. Irving H. Snyder.

Lat. $37^{\circ} 14' N.$; long. $121^{\circ} 59' W.$; distance, 1.04° or 115 km.; direction, $S. 38^{\circ} E.$

Foundation, on soil not far from solid rock.

Seismograms, sheet No. 3.

The instruments used were Rocker seismographs. Two lead bars are each supported at the center of two thin circular segments, so that they rock easily on a smooth plate, one in a north-south, and one in an east-west direction. The movements of these rockers are recombined by means of levers and a record is made on smoked glass entirely analogous to the records of a Ewing duplex pendulum. The movement of the earth was magnified about four times.

The arrows show the directions of the motions. If the marking point is supposed stationary, it would be necessary to interchange the directions north and south, east and west, in order to represent the true movement of the earth. The movement seems to have begun in the blurred mark near the middle of the seismogram and the first distinct movement of the pointer was towards the west, and therefore the first distinct movement of the earth was towards the east. This was followed by movements in various directions; the violence of the disturbance quickly disarranged the rockers, and the record is very incomplete. The recorded earth-amplitude is only 5 mm.; but this was much less than the real maximum.

MOUNT HAMILTON, CALIFORNIA.

Lick Observatory. Prof. W. W. Campbell, director.

Lat. $37^{\circ} 20' N.$; long. $121^{\circ} 39' W.$; altitude, 4,210 meters; distance, 1.16° or 129 km.; direction, $S. 53^{\circ} E.$

Foundation, solid rock; the observatory is on the summit of Mount Hamilton.

Seismograms, sheet No. 3.

The instruments used were: (1) Ewing three-component seismograph; V : north-south component, 4.2; east-west component, 4; vertical component, 1.8. The reproduced seismogram is only half the size of the original and therefore it only magnifies the displacements half as much as indicated above.

(2) Ewing duplex pendulum, V , 4. In reading the actual movement of the ground from the duplex record we must interchange the directions east and west. Both instruments record on smoked glass. The duplex record shows that the earth first moved for a distance of 7 mm. in a direction $S. 60^{\circ} E.$, that is, away from the origin; this was followed with some irregularity, by several vibrations parallel with this direction, with increasing amplitude, and then the movement became confused; there was much jumping of the pen, and as much of the movement was not recorded, the pen must have been held off the plate. Unfortunately we can not say positively when the movement recorded on this instrument began, but its amplitude makes it most probable that it began at the same time as the record on the other instrument, namely at $5^h 12^m 45^s$.

Altho the earthquake was first felt at Mount Hamilton at $5^h 12^m 12^s$, the Ewing three-component seismograph was not set in motion until $5^h 12^m 45^s$; that is, it was started by the violent shock. This was the nearest instrument to the centrum that was driven by a clock and which separated the various phases of the shock. We note that for 9 seconds the disturbance was comparatively slight and then came the strong movement which carried the pens beyond the limits of the glass plate. The north-south component was soon caught and, with the exception of one spasmodic swing across the plate, did not record again for 1 minute 40 seconds, by which time the disturbance had very much diminished. The east-west component seems to have been better placed, for altho

the pen swung well off the plate, it does not seem to have been caught for more than a few seconds at a time. The vertical component recorded but little even during the earlier phase, and when the heavy shock began, 9 seconds after the beginning, it was so deranged that it became permanently caught and incapable of vibrating, so that its record is simply a circle on the plate. The seismogram shows that there were at first two complete vibrations in a direction about northwest and southeast; the period of the first was about 1 second, that of the second about 4 seconds. The first movement was towards the southeast and amounted to 7 mm.; the second movement in that direction was twice as far. The vertical movement was first upward and amounted to about 15 mm.; the period was about twice as long as that of the horizontal motion. But this may be due to derangement by the shock. This shows quite clearly that the first movement of the ground was directed away from the origin of the shock.

At the beginning of the strong motion, at 5^h 12^m 54^s, the vibration had a period of about 2 seconds which soon increased to 4 or 5 seconds and, at times, was even as great as 10 seconds. The north-south component, as recorded at 5^h 13^m 12^s, shows an earth-amplitude of 4 cm. The maximum east-west amplitude recorded was about the same. The beginning of the strong movement was directed towards the northwest.

CARSON CITY, NEVADA.

Carson Observatory. Prof. C. W. Friend, director.¹

Lat. 39° 10' N.; long. 119° 46' W.; altitude, 1,420 meters; distance, 2.62° or 291 km.; direction, N. 64° E.

Seismograms, sheet No. 3.

The instrument used was a Ewing duplex pendulum, V, 4.

Altho the seismogram shows movements in all directions, it differs very materially from the seismograms of similar instruments nearer the origin. We do not find the sudden and irregular changes in direction, but the changes are rather gentle. At this distance from the origin the disturbance had become a gentle swing with a period of about 3 seconds.

Professor Friend gave the time of arrival of the disturbance as 5^h 12^m 25^s. This is 3 seconds before the occurrence of the heavy shock; and we are led to the inquiry whether it may not refer to the earlier light disturbance, which occurred at 5^h 11^m 58^s. This, however, is negatived by two facts. If the first disturbance was felt at Carson City, the violent shock, which was many times stronger, should have been felt at a far greater distance, whereas Winnemucca and Eureka, about twice as far from the origin as Carson City, are the most distant points where the disturbance was noticed, and the intensity at these places was so much less than at Carson City, that we must suppose they all felt the same disturbance; it does not seem possible that Carson City could have felt the earlier and lighter shock and that the violent shock was not felt at far greater distances than Winnemucca and Eureka. Again, if Carson City felt the earlier shock at 5^h 12^m 25^s, 27 seconds after its occurrence, the velocity of transmission would have been 291/27 or 10.8 km./sec. This is greater than can be admitted, for the velocity of transmission increases with the distance measured along the chord, and the velocity for points ten times as far from the origin as Carson City is only about 8.5 km./sec. We are obliged either to suppose that there is an error in the time report from Carson City, or that a light local shock occurred in its neighborhood a few seconds before the violent shock occurred on the coast. The latter could not have been felt at Carson City before 5^h 13^m, and as there is no record there of two disturbances the supposition of a local shock seems improbable. It is very unfortunate that we can not use the Carson City observations to determine the velocity of propagation of the earthquake disturbance.

¹ Professor Friend died in January, 1907.

VICTORIA, BRITISH COLUMBIA.

Meteorological Office. R. F. Stupart, F. R. S. C., director; E. Baynes Reed, superintendent.

Lat. $48^{\circ} 27' N.$; long. $123^{\circ} 22' W.$; altitude, not much above sea-level; distance, 10.41° or 1,157 km.; chord, 1,155 km.; direction, N. $20^{\circ} W.$

Foundation, solid rock.

Seismograms, sheet No. 1.

The instrument used was a Milne horizontal pendulum, east component; photographic registration. T_0 , 15 seconds; V , 6.1; J , 330 meters; angular displacement, 1 mm. = $0.76''$; M , 255 gm.; L , 15.6 cm.

East component: First preliminary tremors, 14.2^m ; second preliminary tremors, 14.7^m ; maximum, 17.1^m ; amplitude, $17+$ mm.

There seems to have been a reinforcement of the motion at 15.2^m , and at 16.1^m the motion was strong enough to join the records from opposite sides of the seismogram; that is, the amplitude of the pointer exceeded 17 mm.; this continued with slight interruptions for 11 minutes, and then diminished with many irregularities. If Victoria recorded only the violent shock, the velocity of propagation would have been $1,155/104 = 11.1$ km./sec., which is far too great; we must therefore believe that the beginning of the record refers to the earlier and lighter motion that began at $5^h 11^m 58^s$ at a point 25 km. further from Victoria. The velocity would then be $1,181/134 = 8.8$ km./sec., which is a little but not much larger than might be expected. The beginning of the strong motion on the seismogram, coming a half minute after the beginning of the record, occurs too early for the long waves from the earlier disturbance, and too early even for the second preliminary tremors. It must represent the first preliminary tremors of the violent shock, whose velocity would then be $1,155/134 = 8.6$ km./sec. We thus get two records of the velocity of the first preliminary tremors; which agree very well when we consider the difficulty of determining the exact point on the seismogram where the movements begin, and the further difficulty of reading the corresponding time as near as a tenth of a minute. The strong motion, beginning at 16.1^m , would correspond in time to the arrival of the second preliminary tremors of the earlier shock, but as this shock was not felt in Sitka it does not seem possible that it could have made so great a record in Victoria, even tho the latter recorded especially the transverse vibrations and the former the longitudinal. The remainder of the record is complicated by the overlapping of vibrations coming apparently from different parts of the fault-plane.

SITKA, ALASKA.

Magnetic Station of U. S. Coast and Geodetic Survey. O. H. Tittmann, superintendent;

Dr. H. M. W. Edmonds, magnetic observer.

Lat. $57^{\circ} 03' N.$; long. $135^{\circ} 20' W.$; altitude, 15 meters; distance, 20.72° or 2,303 km.; chord, 2,291 km.; direction, N. $19^{\circ} W.$

Foundation, directly on solid rock.

Seismograms, sheet No. 11.

The instrument was a Bosch-Omori horizontal pendulum, north component; mechanical registration on smoked paper. T_0 , 14 seconds; V , 10; J , 490 meters; ϵ , 1.0; r , 1.0 mm.; M , 10 kg.; L , 75 cm.

	FIRST PRELIMINARY TREMORS.		SECOND PRELIMINARY TREMORS.		REGULAR WAVES.		MAX.				AMPLITUDE.
	<i>m.</i>	<i>s.</i>	<i>m.</i>	<i>s.</i>	<i>m.</i>	<i>s.</i>	<i>m.</i>	<i>s.</i>	<i>m.</i>	<i>s.</i>	<i>mm.</i>
North component	17	02	21	06	22	32	23	30	to 30	20	65 +
Interval . .	4	34	8	38	10	04					

There were no regular time marks on the seismograms, but certain marks have been made artificially, which enable us to make fair estimates of the times.

The motion begins very gently at 17^m 02^s; at 17^m 32^s a stronger movement occurs, which dies down in a little over a minute; it is possible that this is the true beginning of the first preliminary tremors; at the beginning and soon after the end of this movement there were east-west jars which shook the recording drum and caused an overlapping of the record. The beginning of the second preliminary tremors is about 21^m 06^s with an amplitude of 11 mm. This continued with some irregularity until 22^m 32^s, when the marker went beyond the limits of the paper, *i.e.*, with an amplitude greater than 65 mm. The strong motion lasted about 14.5 minutes to 13^h 36^m, and then the movement continued with small amplitude and occasional reënforcements until about 15^h 17^m. It is not unlikely that the times at Sitka are all about a half-minute too late; this correction would make them accord better with observations from other stations in drawing the hodographs.

The damping is entirely negligible; and the solid friction is not large. The period during the large motion is practically that of the pendulum, so that it is impossible to estimate the magnification, or the actual movement of the earth.

The question arises: Did Sitka, like Victoria, record the early slight shock or only the violent shock? If it recorded the early shock, the average velocity from the origin would have been $2,316/304 = 7.63$ km./sec.; but since this shock reached Victoria at 14.2^m, it must have progressed from that neighborhood to Sitka at a rate of about $(2,316 - 1,180)/170 = 6.7$ km./sec. We can not believe that the disturbance advanced for the first half of the distance to Sitka at a rate of 8.8 km./sec., and for the second half only at a rate of 6.7 km./sec. We are, therefore, obliged to believe that Sitka, which recorded the component at right angles to that recorded at Victoria, really recorded only the violent shock; the velocity for which then becomes $2,291/274 = 8.36$ km./sec., which is about the velocity we should expect.

TACUBAYA, D. F., MEXICO.

Observatorio Astronomico Nacional. Señor F. Valle, director.

Lat. 19° 24' N.; long. 99° 12' W.; altitude, 2,280 meters; distance, 27.70° or 3,081 km.; chord, 3,050 km.; direction, S. 54° E.

Foundation, alluvium.

Seismograms, sheet No. 9.

The instruments used were Bosch-Omori horizontal pendulums, two horizontal components; mechanical registration on smoked paper.

(1) North component: T_0 , 17.3 seconds; V , 15; J , 1,120 meters; M , 10 kg.; L , 75 cm.

(2) East component: T_0 , 17.6 seconds; V , 15; J , 1,160 meters; M , 10 kg.; L , 75 cm.

	FIRST PRELIMINARY TREMORS.		SECOND PRELIMINARY TREMORS.		REGULAR WAVES.	PRINCIPAL PART.	MAX.	AMPLITUDE.	PERIOD.
	<i>m.</i>	<i>s.</i>	<i>m.</i>	<i>s.</i>	<i>m.</i>	<i>s.</i>	<i>m.</i>	<i>s.</i>	<i>mm.</i>
(1) North component	17	58	22	50	25 08	26 40	26 45	50 +	15-25
(2) East component	17	58	22	54	26 06	25 30	26	80 +	
Average . . .	17	58	22	52	25 37	26 05			
Interval . . .	5	30	10	24	13 09	13 37			

The second phase is much stronger on the east component than on the north component, which is due to synchronism of periods; and the long waves begin more definitely on the east component.

The periods during the strong motion approach those of the pendulums and therefore we can not estimate the earth's movement; the fact that the marker goes beyond the limits of the record very near the beginning of the strong motion shows, however, that the earth's displacement was large.

CLEVELAND, OHIO.

St. Ignatius College Observatory. Rev. F. L. Odenbach, S. J., director.

Lat. $41^{\circ} 29' N.$; long. $81^{\circ} 42' W.$; altitude, 230 meters; distance, 31.47° or 3,498 km.; chord, 3,456 km.; direction, $N. 71^{\circ} E.$

Foundation, stiff clay.

Seismograms, sheet No. 3.

The instrument used was a heavy pendulum, prevented from swinging by four carbon rods pressing against it in directions 90° apart. Electric currents pass thru the carbons and the pendulum and then thru carefully balanced solenoids, which carry pens marking on white paper. At the time of a shock the pressure of the pendulum against the carbons, and hence the currents, vary, and the marking pens are displaced, making a record. The preliminary tremors can not be made out; but the principal part begins about $13^h 29.4^m$.

TORONTO, CANADA.

Meteorological Office. R. F. Stupart, F. R. S. C., director.

Lat. $43^{\circ} 40' N.$; long. $79^{\circ} 23' E.$; altitude, 107.5 meters; distance, 32.93° or 3,571 km.; chord, 3,610 km.; direction, $N. 66^{\circ} E.$

Foundation, boulder clay, 32 meters above Lake Ontario.

Seismograms, sheet No. 1.

The instrument used was a Milne horizontal pendulum, east component; photographic registration. T_0 , 14.8 seconds; V , 6.1; J , 330 meters; ϵ , 1.051; angular displacement, 1 mm. = $0.66''$; M , 255 gm.; L , 15.6 cm.

	FIRST PRELIMINARY TREMORS.	SECOND PRELIMINARY TREMORS.	REGULAR WAVES.	MAX.	AMPLITUDE.
East component . . .	<i>min.</i> 19.3	<i>min.</i> 24.5	<i>min.</i> 27.9	<i>min.</i> 33.3	<i>mm.</i> 17 +
Interval	6.8	12.0	15.4		

Beginning given as 19.3^m ; intensified at 24.5^m ; and again at 27.6^m ; at 32.0^m the records join from opposite sides, *i.e.*, the amplitude was greater than 17 mm. This continues with one interruption for 10 minutes. The motion dies down considerably, but at 55.0^m the sides again join for 2 minutes with one small interruption. The remainder of the record is subsiding. The period during the strong motion can not be determined from the seismogram on account of the close time scale, but from records at other stations it could not be very different from that of the pendulum, and this accounts in part for the large amplitude.

HONOLULU, HAWAIIAN ISLANDS.

Magnetic Observatory of U. S. Coast and Geodetic Survey. O. H. Tittmann, superintendent; S. A. Deel, magnetic observer.

Lat. $21^{\circ} 19' N.$; long. $158^{\circ} 04' W.$; distance, 34.60° or 3,846 km.; chord, 3,790 km.; direction, $S. 71^{\circ} W.$

Foundation, directly on solid coral rock.

Seismograms, sheet No. 2.

The instrument used was a Milne horizontal pendulum, east component; photographic registration. T_0 , 19 seconds; V , 6.1; J , 560 meters; M , 255 gm.; L , 15.6 cm.

	FIRST PRELIMINARY TREMORS.	SECOND PRELIMINARY TREMORS.	MAX.	AMPLITUDE.
	<i>min.</i>	<i>min.</i>	<i>min.</i>	<i>mm.</i>
East component . .	19.5	24.4	26.2 to 28.2 28.9 to 32.1	17 +
Interval . . .	7.0	11.9		17 +

The instrument was not perfectly still and the time of the beginning is difficult to determine. The time given is that of the observer in charge. There is a well-marked movement 0.6 minute later, which may mark the arrival of waves reflected once internally at the earth's surface. The time of arrival of the long waves is not definite. There are large vibrations at 26.6^m and others at 29.1^m; the latter fit the hodograph of the regular waves, but they are too uncertain and have not been used.

OTTAWA, CANADA.

Astronomical Observatory. Dr. Otto J. Klotz, director.

Lat. 45° 24' N.; long. 75° 43' W.; altitude, 82 meters; distance, 35.37° or 3,932 km.; chord, 3,871 km.; direction, N. 62° E.

Foundation, boulder clay.

Seismograms, sheet No. 10.

The instruments used were Bosch-Omori horizontal pendulums, two horizontal components; photographic registration.

(1) North component: T_0 , 5.71 seconds; V , 120; J , 970 meters; ϵ , 1.50; r , 0.0 mm.; M , 200 gm.; L , 6.68 cm.

(2) East component: T_0 , 7.06 seconds; V , 120; J , 1,500 meters; ϵ , 1.76; r , 0.0 mm.; M , 200 gm.; L , 6.68 cm.

	FIRST PRELIMINARY TREMORS.	SECOND PRELIMINARY TREMORS.	PRINCIPAL PART.
	<i>m.</i> <i>s.</i>	<i>m.</i> <i>s.</i>	<i>m.</i> <i>s.</i>
(1) North component .	19 25	24 50	30 40
(2) East component .	19 12	31 20 (?)
Average	19 19	24 50	31.0
Interval	6 51	12 22	18.5

The east component began 13 seconds before the north; this indicates that the longitudinal motion began before the transverse. The north earth-amplitude (one minute after the beginning) was 0.004 mm.; and the east earth-amplitude (0.5 minute after beginning) was 0.005 mm. These values are somewhat uncertain on account of the closeness of periods. The periods of the waves are not very different from that of the pendulums. On the north component the motion became so large for 10 minutes after 31.0^m that it can not be followed; it then dies down to quiet at about 16^h 30^m. On the east component the records are superposed so that the phases can not be distinguished after the beginning.

WASHINGTON, DISTRICT OF COLUMBIA.

U. S. Weather Bureau. Prof. Willis L. Moore, chief; Prof. C. F. Marvin in charge of seismographs.

Lat. 38° 54' N.; long. 77° 03' W.; altitude, 20.5 meters; distance, 35.44° or 3,939 km.; chord, 3,878 km.; direction, N. 74° E.

Foundation, firm clay and gravel; solid rock probably within 8 meters.

Seismograms, sheet No. 8.

The instrument used was a Bosch-Omori horizontal pendulum; east component; mechanical registration on smoked paper. T_0 , 32 seconds, V , 10; J , 2,540 meters; ϵ , 1.35; r , 0.56 mm.; M , 17.35 kg.; L , 75.2 cm.

	FIRST PRELIMINARY TREMORS.		SECOND PRELIMINARY TREMORS.		REGULAR WAVES.		PRINCIPAL PART.		MAX.		AMPLITUDE.	
	<i>m.</i>	<i>s.</i>	<i>m.</i>	<i>s.</i>	<i>m.</i>	<i>s.</i>	<i>min.</i>	<i>min.</i>	<i>min.</i>		<i>mm.</i>	
East component . .	19	20	25	00	29	20	30.5	32 to 35		95		
Interval . . .	6	52	12	32	16	52	18.0					

Duration, 4.3 hours. Perhaps the long waves should begin a minute earlier. The very strong motion only lasted about 4.5 minutes. During the second preliminary tremors the period was about 25 seconds, and amplitude 95 mm., corresponding to an earth-amplitude of 0.4 mm. During the regular waves at 32.0^m when the pointer went off the record, the period was about 30 seconds, practically that of the pendulum; so that we can not draw conclusions regarding the actual motion of the ground.

CHELTHENHAM, MARYLAND.

Magnetic Observatory of U. S. Coast and Geodetic Survey. O. H. Tittmann, superintendent; W. F. Wallis, magnetic observer.

Lat. 38° 44' N.; long. 76° 50.5' W.; altitude, 72 meters; distance, 35.64° or 3,962 km.; chord, 3,899 km.; direction, N. 74° E.

Foundation, sands and gravel.

Seismograms, sheet No. 8.

The instruments used were Bosch-Omori horizontal pendulums, two horizontal components; mechanical registration on smoked paper. The corrections to G. M. T. are negative for both components.

(1) North component: T_0 , 20 seconds; V , 10; J , 1,000 meters; M , 10 kg.; L , 75 cm.

(2) East component: T_0 , 25 seconds; V , 10; J , 1,560 meters; M , 10 kg.; L , 75 cm.

	FIRST PRELIMINARY TREMORS.		SECOND PRELIMINARY TREMORS.		REGULAR WAVES.		PRINCIPAL PART.		PERIOD.		AMPLITUDE.	
	<i>m.</i>	<i>s.</i>	<i>m.</i>	<i>s.</i>	<i>m.</i>	<i>s.</i>	<i>min.</i>	<i>sec.</i>	<i>sec.</i>		<i>mm.</i>	
(1) North component	19	30	25	01	30	00	32.3 to 36	13	13		40 +	
(2) East component	19	16	25	09	30	32	32.8 to 39	9	9		35 +	
Average . . .	19	23	25	05	30	16	32.5					
Interval . . .	6	55	12	37	17	48	20.0					

Duration, north, 2.7 hours; east, 3.1 hours. The time of the first preliminary tremors on north component is not very definite, but it is not later than 19^h 30^m. The longitudinal waves apparently arrived some seconds earlier than the transverse. This probably means that the longitudinal waves were first felt, and then the disturbance became more complex. The regular waves are a little earlier on the north than on the east component, as is also the strong motion.

The dying-out curves sent me to determine the damping and friction are too irregular to yield definite results, which is probably due to irregular friction; but if we neglect the damping and frictional terms, we find the magnifying power of the north component for waves of period 13 seconds (13^h 34^m) to be 17.3; and since the amplitude of the pendulum is 40 mm. that of the earth would be 2.3 mm.; with the same assumption, the magnifying power of the east component for waves of period 9 seconds (13^h 36^m) is 11; and the corresponding earth-amplitudes, 3.2 mm. But both of these values are too small, as the movements of the pendulums seem to have been limited by the stops. It is not unlikely that the total earth-amplitude at Cheltenham may have amounted to 5 mm.

BALTIMORE, MARYLAND.

Johns Hopkins University. Prof. Harry Fielding Reid, in charge of seismographs.
 Lat. $39^{\circ} 18' N.$; long. $76^{\circ} 37' W.$; altitude, 30 meters; distance, 35.74° or 3,973 km.;
 chord, 3,909 km.; direction, N. $73^{\circ} E.$

Foundation, clays and gravels, about 30 meters thick, resting on rock.

Seismograms, sheet No. 1.

The instrument used was a Milne horizontal pendulum; component, N. $60^{\circ} W.$; photographic registration. T_0 , 14 seconds; V , 6.1; J , 300 meters; ϵ , 1.03; r , 0.0 mm.; angular displacement, 1 mm. = $0.83''$; M , 255 gm.; L , 15.6 cm.

	FIRST PRELIMINARY TREMORS.	SECOND PRELIMINARY TREMORS.	PRINCIPAL PART.	MAX.	AMPLITUDE.
	<i>min.</i>	<i>min.</i>	<i>min.</i>	<i>min.</i>	<i>mm.</i>
N. $60^{\circ} W.$ component	19.4	25.2	31.6	31.8 to 39.1	17 +
Interval	6.9	12.7	19.1		

If we assume that the wave period at Baltimore was the same as that at Cheltenham, namely, 13 seconds, we see that the large amplitude at this station is due to synchronism of periods of the waves and the pendulums.

ALBANY, NEW YORK.

New York State Museum. Dr. John M. Clarke, State geologist.

Lat. $42^{\circ} 39' N.$; long. $73^{\circ} 45' W.$; altitude, 26 meters; distance, 37.13° or 4,128 km.;
 chord, 4,056 km.; direction, N. $67^{\circ} E.$

Foundation, heavy blue clay with interbedded sand and gravel.

Seismograms, sheet No. 8.

The instruments used were Bosch-Omori horizontal pendulums, two horizontal components; mechanical registration on smoked paper. Constants for both components: T_0 , 30 seconds; V , 10; J , 2,240 meters; M , 11.28 kg.; L , 85.5 cm.

	FIRST PRELIMINARY TREMORS.	SECOND PRELIMINARY TREMORS.	REGULAR WAVES.	PRINCIPAL PART.	MAX.	AMPLITUDE.
	<i>m.</i> <i>s.</i>	<i>m.</i> <i>s.</i>	<i>m.</i> <i>s.</i>	<i>min.</i>	<i>m.</i> <i>s.</i>	<i>mm.</i>
(1) North component	21 30	29 04	33 00	33.5 to 35.5	34 30	32
(2) East component	21 30	28 00	32 30	34.0 to 42	34 40	22
Average	21 30	28 32	32 45	33.7		
Interval	9 02	16 04	20 17	21.2		

Duration, north, 2.1 hours; east, 2.7 hours. The times of the preliminary tremors are two or three minutes too late. The strong motion on the east component lasted about 9 minutes, on the north component only 2 minutes; but the greatest amplitude was shown by the latter. The strong motion was not regular nor long enough to estimate the amplitudes of the earth's motion.

PORTO RICO (VIEQUES), WEST INDIES.

Magnetic Observatory of U. S. Coast and Geodetic Survey. O. H. Tittmann, superintendent; P. H. Dike, magnetic observer.

Lat. $18^{\circ} 08' N.$; long. $65^{\circ} 26' W.$; altitude, 40 meters; distance, 53.45° or 5,942 km.;
 chord, 5,729 km.; direction, S. $85^{\circ} E.$

Seismograms, sheet No. 8.

The instruments used were Bosch-Omori horizontal pendulums, two horizontal components; mechanical registration on smoked paper.

(1) North component: T_0 , 20 seconds; V , 10; J , 1,000 meters; ϵ , 1.066; r , 3.25 mm.; M , 11 kg.; L , 75 cm.

(2) East component: T_0 , 21 seconds; V , 10; J , 1,100 meters; ϵ , 1.0; r , 2.6 mm.; M , 11 kg.; L , 75 cm.

	FIRST PRELIMINARY TREMORS.		SECOND PRELIMINARY TREMORS.		REGULAR WAVES.	PRINCIPAL PART.	MAX.		AMPLITUDE.
	<i>m.</i>	<i>s.</i>	<i>m.</i>	<i>s.</i>	<i>min.</i>	<i>min.</i>	<i>m.</i>	<i>s.</i>	<i>mm.</i>
(1) North component	21	45	30	24	40?	43 to 50?	48	50	24
(2) East component	21	54	29	50	39?	47.5 to 54.5?	50	0	30
Average . . .	21	50	30	07	39.5?				
Interval . . .	9	22	17	39	27.0?				

Duration, north, 2 hours; east, 2.5 hours. The periods of the waves coincide with periods of the pendulums and the strong motion lasted too short a time to enable an estimate of the earth's motion to be made. There seems to have been a certain amount of separation of the north and east components of the waves, as the strong motion of each occurs when that of the other is much reduced. The regular waves do not appear very definitely.

TRINIDAD, BRITISH WEST INDIES.¹

St. Clair Experiment Station of the Botanical Gardens. J. H. Hart, F. L. S., superintendent.

Lat. $10^{\circ} 40'$ N.; long. $61^{\circ} 30'$ W.; altitude, 20.5 meters; distance, 60.94° or 6,774 km.; chord, 6,460 km.; direction, S. 80° E.

Foundation, 2 meters of concrete laid on sands and clays.

The instrument used was a Milne horizontal pendulum, east component; photographic registration. T_0 , 18 seconds; V , 6.1; J , 490 meters; angular displacement, 1 mm. = $0.5''$; M , 255 gm.; L , 15.6 cm.

Preliminary tremors, 11^m ; regular waves, 42^m ; maximum, 53^m ; amplitude, 10^m . Interval for regular waves, 29.5 minutes.

The record of the commencement is evidently erroneous. The time of arrival of the regular waves at 42^m may be fairly correct. Duration 3.2 hours.

APIA, SAMOA.²

Observatorium der Kgl. Gesellschaft der Wissenschaften in Göttingen. Dr. F. Linke, director.

Lat. $13^{\circ} 48'$ S.; long. $171^{\circ} 46'$ W.; distance, 69.20° or 7,694 km.; chord, 7,235 km.; direction, S. 52° W.

The instrument used was a Wiechert inverted pendulum (1,000 kg.), two horizontal components; mechanical registration on smoked paper.

First preliminary tremors, $23^m 22^s$; interval, $10^m 54^s$.

Second preliminary tremors, $32^m 24^s$; interval, $19^m 56^s$.

¹ The data were obtained from Circular 14 of the Seismological Committee of the B. A. A. S.

² Information obtained from Wiechert and Zoeppritz, "Ueber Erdbebenwellen"; Nach. Kgl. Gesell. Wissen. Göttingen, Math.-Phys. Kl., 1907.

MIZUSAWA, JAPAN.¹

Meteorological Observatory.

Lat. 39° 08' N.; long. 141° 07' E.; distance, 70.46° or 7,834 km.; chord, 7,349 km.; direction, N. 55° W.

The instrument used was an Omori horizontal pendulum; mechanical registration on smoked paper.

First preliminary tremors, 24^m 07^s; interval, 11^m 39^s.

Second preliminary tremors, 33^m 14^s; interval, 20^m 46^s.

Apia has a Wiechert pendulum which magnifies more than the Omori at Mizusawa and therefore probably showed the movement more promptly.

PONTA DELGADA, AZORES.

Serviço Meteorologico dos Açores. Major F. A. Chaves, director.

Lat. 37° 44' N.; long. 25° 41' W.; altitude, 16 meters; distance, 72.53° or 8,064 km.; chord, 7,536 km.; direction, N. 55° E.

Foundation, basaltic rock in a volcanic region.

Seismograms, sheet No. 1.

The instrument used was a Milne horizontal pendulum, east component; photographic registration. V , 6.1; angular displacement, 1 mm. = 0.49"; M , 255 gm.; L , 15.6 cm.

	FIRST PRELIMINARY TREMORS.	PRINCIPAL PART.	MAX.	AMPLITUDE.
East component . .	<i>min.</i> 23.6	<i>min.</i> 50.5 ?	<i>min.</i> 54.6	<i>mm.</i> 7.3
Interval . . .	11.1	38.0 ?		

Duration, 3.5 hours. The second preliminary tremors are not distinguishable. There is a curious difference between the seismograms of Ponta Delgada and those of Paisley and Edinburgh, at practically the same distance from the origin. In the former, the first preliminary tremors are stronger and the beginning of the second preliminary tremors are not clearly differentiated; in the two latter, the first preliminary tremors are very feeble but the second preliminary tremors begin sharply.

PAISLEY, SCOTLAND.

Coats Observatory. David Crilley, director.

Lat. 55° 51' N.; long. 4° 26' W.; altitude, 32 meters; distance, 72.54° or 8,065 km.; chord, 7,537 km.; direction, N. 31° E.

Foundation, boulder clay.

Seismograms, sheet No. 1.

The instrument used was a Milne horizontal pendulum, east component; photographic registration. T_0 , 17 seconds; V , 6.1; J , 440 meters; angular displacement, 1 mm. = 0.55"; M , 255 gm.; L , 15.6 cm.

	FIRST PRELIMINARY TREMORS.	SECOND PRELIMINARY TREMORS.	REGULAR WAVES.	PRINCIPAL PART.	MAX.	AMPLITUDE.
East component . .	<i>min.</i> 23.2	<i>min.</i> 33.3	<i>min.</i> 47.4	<i>min.</i> 51.0 to 0.0	<i>min.</i> 54 to 57	<i>mm.</i> 17 +
Interval . . .	10.7	20.8	34.9	38.5		

Duration, 4.1 hours. The period of the long waves was from 25 to 30 seconds.

¹ Information obtained from "Preliminary Note on the Seismographic Observations of the San Francisco Earthquake," by F. Omori, Bull. Imperial Earthquake Investigation Commission, vol. 1, No. 1.

BERGEN, NORWAY.¹

Seismical Station of the Museum. Prof. Dr. Carl F. Kolderup, director.

Lat. 60° 24' N.; long. 5° 18' E.; altitude, 20 meters; distance, 72.79° or 8,092 km.; chord, 7,560 km.; direction, N. 24° E.

The instruments used were Bosch-Omori horizontal pendulums, two components; mechanical registration on smoked paper; *V*, 15.

	FIRST PRELIMINARY TREMORS.		SECOND PRELIMINARY TREMORS.		PRINCIPAL PART.		MAX.		PERIOD.	AMPLITUDE.
	<i>m.</i>	<i>s.</i>	<i>m.</i>	<i>s.</i>	<i>m.</i>	<i>s.</i>	<i>m.</i>	<i>s.</i>	<i>sec.</i>	<i>mm.</i>
(1) North component	22	46	32	09	54	45	18	5.0
(2) East component	22	56	32	20	51	44	55	06	15	50.0
Average . . .	22	51	32	15	51	44	54	55		
Interval . . .	10	23	19	47	39	16	42	27		

The great difference between the maximum amplitudes is probably due to differences in the periods of the two pendulums.

EDINBURGH, SCOTLAND.

Royal Observatory. Thomas Heath, director.

Lat. 55° 55.5' N.; long. 3° 11' W.; altitude, 131.5 meters; distance, 72.99° or 8,115 km.; chord, 7,578 km.; direction, N. 31° E.

Foundation, Devonian lava.

Seismograms, sheet No. 1.

The instrument used was a Milne horizontal pendulum, east component. *T*₀, 17 seconds; *V*, 6.1; *J*, 440 meters; ϵ , 1.11; angular displacement, 1 mm. = 0.54"; *M*, 255 gm.; *L*, 15.6 cm.

	FIRST PRELIMINARY TREMORS.	SECOND PRELIMINARY TREMORS.	REGULAR WAVES.	PRINCIPAL PART.	MAX.	AMPLITUDE.
	<i>min.</i>	<i>min.</i>	<i>min.</i>	<i>min.</i>	<i>min.</i>	<i>mm.</i>
East component .	23.5	33.0	48.0	52.0 to 05.6	54.2 to 56.7	17 +
Interval . .	11.0	20.5	35.5	39.5		

Duration, 3.7 hours.

TOKYO, JAPAN.

Tokyo Imperial University. Prof. F. Omori, D. Sc., director.

Lat. 35° 42.5' N.; long. 139° 46' E.; distance, 73.92° or 8,217 km.; chord, 7,660 km.; direction, N. 57° W.

Seismograms, sheet No. 11.

The instrument used was an Omori horizontal pendulum, east component; mechanical registration on smoked paper. *T*₀, 41.5 seconds; *V*, 30; *J*, 1,290 meters; *M*, 16.5 kg.; *L*, 75 cm.

	(a) FIRST PRELIMINARY TREMORS.	(b) SECOND PRELIMINARY TREMORS.	REGULAR WAVES.	(d) PRINCIPAL PART.	MAX.	AMPLITUDE.			
	<i>m.</i>	<i>s.</i>	<i>m.</i>	<i>s.</i>	<i>m.</i>	<i>s.</i>	<i>mm.</i>		
East component	24	35	34	24	46	20	50 15	46 45 to 48 10	93 +
Interval . .	12	07	21	56	33	52	37 47		

¹ The information was obtained from "Registrierungen an der seismischen Station in Bergen in Jahre 1906," by Carl F. Kolderup. Bergens Museum Aarbo, 1907, 2 Hefte. A mechanical reproduction of the seismogram there is given.

At 15^h 31^m, (f), vibrations propagated along major arc, according to Professor Omori. The large amplitudes shown, both at the beginning of the second preliminary tremors and in the long waves are due to approximate synchronism of periods of the waves and the pendulum.

BIDSTON, ENGLAND.

Liverpool Observatory. W. E. Plummer, director.

Lat. 53° 24' N.; long. 3° 04' W.; altitude, 54 meters; distance, 74.81° or 8,317 km.; chord, 7,739 km.; direction, N. 33° E.

Foundation, sandstone.

Seismograms, sheet No. 1.

The instrument used was a Milne horizontal pendulum, east component; photographic registration. T_0 , 18.7 seconds; V , 6.1; J , 530 meters; ϵ , 1.057; M , 255 gm.; L , 15.6 cm.

	FIRST PRELIMINARY TREMORS.	SECOND PRELIMINARY TREMORS.	REGULAR WAVES.	PRINCIPAL PART.	MAX.	AMPLITUDE.
	<i>min.</i>	<i>min.</i>	<i>min.</i>	<i>min.</i>	<i>min.</i>	<i>mm.</i>
East component	24.3	34.0	48.2	51.6	54.3, 56.3 to 58.2	17 +
Interval	11.8	21.5	35.7	39.1		

Duration, 4.1 hours. The regular waves can be recognized by their greater period, which amounts to 24 seconds against 19 seconds during the principal part; this becomes still shorter during the strongest part of the disturbance. A comparison with the seismograms of Edinburgh, Paisley, and Kew also help to identify this phase, tho there is not so marked a change in amplitude at its beginning as in the other seismograms mentioned.

UPSALA, SWEDEN.

Meteorological Observatory of the University. Prof. Dr. H. H. Hildebrandsson, director.

Lat. 59° 51.5' N.; long. 17° 37.5' E.; altitude, 16 meters; distance, 76.80° or 8,538 km.; chord, 7,914 km.; direction, N. 19° E.

Seismograms, sheet No. 9.

The instrument used was a Wiechert inverted pendulum, two horizontal components; mechanical registration on smoked paper.

(1) North component: T_0 , 6.8 seconds; V , 230; J , 2,650 meters; ϵ , 3; M , 1,000 kg.; L' , 11.5 meters; L , 1 meter.

(2) East component: T_0 , 5.3 seconds; V , 270; J , 1,900 meters; ϵ , 3; M , 1,000 kg.; L' , 11.5 meters; L , 1 meter.

	FIRST PRELIMINARY TREMORS.	SECOND PRELIMINARY TREMORS.	REGULAR WAVES.	PRINCIPAL PART.	MAX.	AMPLITUDE.	PERIOD.
	<i>m. s.</i>	<i>m. s.</i>	<i>m. s.</i>	<i>m. s.</i>	<i>m. s.</i>	<i>mm.</i>	<i>sec.</i>
(1) North component	24 51	34 43	50 20	54 05	55 00 59 15 02 45	46 50 57	15
(2) East component	24 51	34 45	52 00 to 55	54 00	15	
Average . . .	24 51	34 44	50 20	53 02?			
Interval . . .	12 23	22 16	37 52	40 34?			

Duration, 3 hours. The first and second preliminary tremors are especially well defined. The amplitudes of the long waves are about equal on the north and on the east components; what appears to be the principal part on the east corresponds to dying down of regular waves on north. It is curious that the strongest motion of east occurs when

north is weak, and the first strong maximum, at 55^m of north, is at the weakest part of east. The other north maxima do not correspond to any reinforcement of the east component. The largest earth-amplitude occurred between 13^h 50^m and 52^m and amounted, on the north component, to 3.6 mm.; on the east component, to 3.76 mm. At the maximum displacement of the north needle (14^h 02^m 45^s) the earth-amplitude was only 1.2 mm. and at the maximum displacement of the east needle (13^h 54^m) the earth-amplitude was 1.9 mm.; a half minute earlier the north earth-amplitude was 2.8 mm.

SHIDE, ISLE OF WIGHT, ENGLAND.

Prof. John Milne, F. R. S., director.

Lat. 50° 41' N.; long. 1° 17' W.; altitude, 15 meters; distance, 77.08° or 8,569 km.; chord, 7,938 km.; direction, N. 34° E.

Foundation, disintegrated chalk over solid chalk.

The instruments used were:

(1) Milne horizontal pendulum, east component. Time scale, 1 mm. to 1 minute. T_0 , 20 seconds; V , 6.1; J , 600 meters; M , 255 gm.; angular displacement, 1 mm. = 0.36"; L , 15.6 cm.

(2) Milne Horizontal Pendulum, east component; time scale, 4.25 mm. to 1 minute. Seismograms, sheet No. 12. V , 6.1; M , 255 gm.; L , 15.6 cm.

Heavy horizontal pendulums, supported by an iron post more than 2 meters high. Seismograms, sheet No. 7.

(3) North component: V , 25.4; ϵ , 1.24; r , 0.2 mm.; M , 45 kg.; L , 1.030 meters.

(4) East component: V , 8.3; ϵ , 1.51; r , 0.0; M , 45 kg.; L , 1.030 meters.

	FIRST PRELIMINARY TREMORS.	SECOND PRELIMINARY TREMORS.	REGULAR WAVES.	PRINCIPAL PART.	MAX.	AMPLITUDE.
(1) East component	<i>min.</i> 23.7	<i>min.</i> ...	<i>min.</i> ...	<i>min.</i> ...	<i>min.</i> 58.2	<i>mm.</i> 17 +
(2) East component	24.1	34.2	49.7	...	57.1	16
(3) North component	25.0	...	51.4	56.6	01.8	20
(4) East component	50.7	...	58.0 to 01.5	70 +
					54	17 +
Average . . .	<i>m. s.</i> 24 16	<i>m. s.</i> 34 12	<i>m. s.</i> 50 36			
Interval . . .	11 48	21 44	38 08			

Duration (1) 4.4 hours; (2) 4.8 hours. The large amplitudes are probably due to coincidence of periods; they occur at different times for the different pendulums.

OSAKA, JAPAN.

Meteorological Observatory. N. Shimono, director.

Lat. 34° 42' N.; long. 135° 31' E.; distance, 77.30° or 8,594 km.; chord, 7,957 km.; direction, N. 56° W.

Seismograms, sheet No. 15.

The instrument used was an Omori horizontal pendulum, east component; mechanical registration on smoked paper. T_0 , 27 seconds; V , 20; J , 3,600 meters.

	(a) FIRST PRELIMINARY TREMORS.	(b) SECOND PRELIMINARY TREMORS.	(d) REGULAR WAVES.	MAX.	AMPLITUDE	PERIOD.
	<i>m. s.</i>	<i>m. s.</i>	<i>m. s.</i>	<i>m. s.</i>	<i>mm.</i>	<i>sec.</i>
East component .	24 24	34 13	47 56	50 19	44	25
Interval . .	11 56	21 45	35 28	50 03	31	

Duration, 3.1 hours. The period during the strong motion is closely that of the pendulum and in the absence of strong damping and exact knowledge of the damping ratio, the movement of the earth can not be estimated. The letters on the seismogram refer to the following times: *a*, 13^h 24^m 24^s; *b*, 34^m 13^s; *c*, 42^m 26^s; *d*, 47^m 56^s; *e*, 53^m 51^s; *f*, 14^h 10^m 22^s; *g*, 25^m 43^s; *h*, 15^h 01^m 46^s; *i*, 40^m 11^s; *j*, 16^h 33^m 08^s.

KOBE, JAPAN.

Meteorological Observatory. C. Nakagawa, director.

Lat. 34° 41' N.; long. 136° 10' E.; altitude, 53.3 meters; distance, 77.54° or 8,619 km.; chord, 7,976 km.; direction, N. 55° W.

Foundation, Paleozoic rocks.

Seismograms, sheet No. 5.

The instrument used was an Omori horizontal pendulum, north component; mechanical registration on smoked paper. T_0 , 35 seconds; V , 10; J , 3,000 meters; M , 5 kg.; L , 75 cm.

	(a) FIRST PRELIMINARY TREMORS.		(b) SECOND PRELIMINARY TREMORS.		REGULAR WAVES.		MAX.		AMPLITUDE.	PERIOD.
	<i>m.</i>	<i>s.</i>	<i>m.</i>	<i>s.</i>	<i>m.</i>	<i>s.</i>	<i>m.</i>	<i>s.</i>	<i>mm.</i>	<i>sec.</i>
North component . .	24	23	34	19	50	20	52	56	15	23
Interval . . .	11	55	21	51	37	52				

Duration, 3 hours. Altho the long waves appear quite definitely to begin at (c), the time seems somewhat late. There are two well-marked but separated waves in this part of the motion with a period of 31 seconds and a very large amplitude, possibly in part due to harmony of periods. The amplitude of the earth during the principal part can not be determined as the motion lasted only a short time and the damping is small.

The letters on the seismogram refer to the following times: *a*, 13^h 24^m 23^s; *b*, 34^m 19^s; *c*, 45^m 31^s; *d*, 53^m 39^s; *e*, 59^m 55^s; *f*, 14^h 06^m 06^s; *g*, 12^m 32^s; *h*, 22^m 29^s; *i*, 57^m 35^s; *j*, 16^h 26^m 13^s.

KEW, ENGLAND.

National Physical Laboratory. Dr. Charles Chree, in charge of seismograph.

Lat. 51° 28' N.; long. 0° 19' W.; altitude, 6 meters; distance, 77.63° or 8,630 km.; chord, 7,986 km.; direction, N. 32° E.

Foundation, deep alluvial gravel; Mesozoic limestone 1,150 feet below the surface.

Seismograms, sheet No. 1.

The instrument used was a Milne horizontal pendulum, east component; photographic registration. T_0 , 18 to 19 seconds; V , 6.1; J , 520 meters; ϵ , 1.114; r , 0.0 mm.; angular displacement, 1 mm. = 0.55"; M , 255 gm.; L , 15.6 cm.

	FIRST PRELIMINARY TREMORS.	SECOND PRELIMINARY TREMORS.	REGULAR WAVES.	MAX.	AMPLITUDE
	<i>min.</i>	<i>min.</i>	<i>min.</i>	<i>min.</i>	<i>mm.</i>
East component . . .	25.7	34.0	50.0	57.0 to 02.0	17 +
Interval . . .	13.2	21.5	37.5		

Duration, 3.8 hours. The time of the first preliminary tremors has not been used in the determination of velocity of propagation; it is fully a minute later than at all other stations which do not differ considerably from Kew in distance from the focus; and the beginning of the movement on the seismogram is too indefinite to permit a satisfactory determination of its time.

HAMBURG, GERMANY.

Hauptstation für Erdbebenforschung. Dr. R. Schütt, director.

Lat. 53° 34' N.; long. 9° 59' E.; altitude, 16.2 meters; distance, 79.74° or 8,866 km.;
chord, 8,167 km.; direction, N. 26° E.

The instruments used were Rebeur-Paschwitz horizontal pendulums, modified by Dr. Hecker, two components; photographic registration.

	FIRST PRELIMINARY TREMORS.		SECOND PRELIMINARY TREMORS.		REGULAR WAVES.		PRINCIPAL PART.	
	<i>m.</i>	<i>s.</i>	<i>m.</i>	<i>s.</i>	<i>m.</i>	<i>s.</i>	<i>m.</i>	<i>s.</i>
North component	34	42	51	57
East component . .	24	32	34	57	44	32	51	34
Average	24	32	34	50	44	32	51	45
Interval	12	04	22	22	32	04	39	17

UCCLE, BELGIUM.

Observatoire Royale de Belgique. M. G. Lecointe, director.

Lat. 50° 48' N.; long. 4° 22' E.; altitude, 100 meters; distance, 79.80° or 8,872 km.;
chord, 8,173 km.; direction, N. 31° E.

Foundation, coarse Tertiary limestone.

Seismograms, sheet No. 2 *a*.

The instrument used was an Ehlert triple pendulum, photographic registration.

(1) N. 60° E. component: T_0 , 11.25 seconds; V , 160; J , 5,100 meters; ϵ , 1.003; r , 0.0 mm.; M , 185 gm.; L , 10.08 cm.

(2) N. 60° W. component: T_0 , 10.53 seconds; V , 160; J , 4,400 meters; ϵ , 1.004; r , 0.0 mm.; M , 185 gm.; L , 10.08 cm.

(3) North component: T_0 , 11.15 seconds; V , 160; J , 5,100 meters; ϵ , 1.004; r , 0.0 mm.; M , 185 gm.; L , 10.08 cm.

	FIRST PRELIMINARY TREMORS.		REGULAR WAVES.	
	<i>m.</i>	<i>s.</i>	<i>m.</i>	<i>s.</i>
(1) N. 60° E. component . .	24	27	34	57
(2) N. 60° W. component . .	24	27	34	57
(3) North component	24	27	34	57
Average	24	27	34	57
Interval	11	59	22	29

All three pendulums suffered permanent displacements during the disturbance.

JURJEW, RUSSIA.

Astronomical Observatory of the University. Prof. Dr. G. Lewitsky, director; Dr. A. Orloff, assistant.

Lat. 58° 23' N.; long. 26° 43' E.; altitude, 48.5 meters; distance, 80.27° or 8,924 km.; chord, 8,212 km.; direction, N. 16° E.

Foundation, fine sand.

Seismograms, sheet No. 10.

The instruments used were Zöllner-Repsold horizontal pendulums, two components; photographic registration.

(1) North component: T_0 , 31.53 seconds; V , 64.5; J , 15,000 meters; ϵ , 1.004; r , 0.0 mm.; M , 50 gm.; L , 13.3 cm.

(2) East component: T_0 , 28.22 seconds; V , 64.9; J , 13,000 meters; ϵ , 1.005; r , 0.0 mm.; M , 50 gm.; L , 13.3 cm.

	FIRST PRELIMINARY TREMORS.		SECOND PRELIMINARY TREMORS.	
	<i>m.</i>	<i>s.</i>	<i>m.</i>	<i>s.</i>
(1) North component . . .	24	45	34	43
(2) East component . . .	24	41	34	49
Average	24	43	34	46
Interval	12	15	22	18

The seismograms are carefully drawn from the original, parts of which were so faint, on account of the rapid movement, that they could not be reproduced. (The correction to G. M. T. should be +43 seconds and not -43 seconds, as marked on the seismograms.) The north component begins in the middle of the sheet at the bottom of the seismogram; it had an amplitude of 15 mm. when the sheet was put on. This movement gradually died down, but the pendulum was not perfectly still when the earthquake arrived 3^h 10^m later. The first preliminary tremors have a small amplitude, about 1 mm., and a period the same as the period of the pendulum, showing an extremely small disturbance. The second preliminary tremors have an increasing amplitude from about 10 mm. to 20 mm.; at 13^h 50^m 45^s the motion becomes so large and the photographic record so faint that it can not be copied; a few turning points are shown in the lower part of the plate; this continues for the rest of this line. The record is again picked up at the beginning of the next line at about 14^h. The center of the record is shown by the single line on the left of the plate. The movement gradually dies down, but still has an amplitude of 20 mm. two hours later. The east component begins in the middle of the sheet; it has small oscillations which entirely die out before the preliminary tremors arrive. The first preliminary tremors and second preliminary tremors begin at the same time as those of the north component, but they have larger amplitudes, the first attaining an amplitude of 7 mm.; and the second, beginning with nearly 50 mm., attain 120 mm. by 13^h 48^m, and a few minutes later (13^h 53^m 45^s) are lost. They are picked up again 8 minutes later, and about 14^h 25^m drop to an amplitude of about 40 mm.; they then gradually die out more irregularly than the other component. The very large amplitudes are due to synchronism of the periods of the waves and the pendulums.

IRKUTSK, SIBERIA.

Meteorological and Magnetic Observatory. M. A. Voznesenskij, director.

Lat. 52° 16' N.; long. 57° 14' E.; altitude, 470 meters; distance, 80.82° or 8,986 km.; chord, 8,259 km.; direction, N. 27° W.

Foundation, hard Jurassic clay.

The instruments used were:

Repsold-Zöllner horizontal pendulums, two components; photographic registration.

Seismograms, sheet No. 2 *a*.

(1) North component: T_0 , 35 seconds; V , 57.5; J , 17,500 meters; angular displacement, 1 mm. = 0.011"; M , 30 gm.; L , 14 cm.

(2) East component: T_0 , 25.5 seconds; V , 57.5; J , 9,300 meters; angular displacement, 1 mm. = 0.021"; M , 30 gm.; L , 14 cm.

Bosch-Omori horizontal pendulums, two components; mechanical registration on smoked paper. Seismograms, sheet No. 13.

(3) North and (4) East components: T_0 , 24 seconds; V , 10 (?); J , 1,430 meters (?); M , 11 kg. (?); L , 75 cm. (?).

(5) Milne horizontal pendulum, east component, photographic registration. Seismograms, sheet No. 2. T_0 , 20.5 seconds; V , 6.1; J , 700 meters; M , 255 gm.; L , 15.6 cm.

	FIRST PRELIMINARY TREMORS.	SECOND PRELIMINARY TREMORS.	REGULAR WAVES.	MAX.	AMPLITUDE.	PERIOD.
	<i>min.</i>	<i>min.</i>	<i>min.</i>	<i>min.</i>	<i>mm.</i>	<i>sec.</i>
(1) North component .	24.6	34.3	...	54.6	165	
(2) East component .	24.7	34.4	...	58.7	87.6	
(3) North component .	24.7	35.0	...	02.7	4.0	24
(4) East component .	24.6	34.5	...	01.0	6.0	
(5) East component .	24.4	34.3	51.3	05.3	17 +	
Average	<i>m.</i> 24 <i>s.</i> 36	<i>m.</i> 34 <i>s.</i> 50	51.3			
Interval	12 08	22 22	38.8			

Duration, (1) and (2), 6.5 hours; (3) 2.5; (4) 2.7; (5) 4.6.

On the Zöllner-Repsold records there is no clear evidence of long waves. The strong motion seems to have been stronger and to have lasted longer on the east component; it also began nearly two minutes earlier; but the north component shows a marked movement between 16^h and 18^h which is lacking in the east movement.

It is interesting to compare the records from the similar instruments at Jurjew and Irkutsk, which are practically the same distance from the centrum. We find certain differences; at Jurjew the north component is apparently the stronger and holds its strong motion longer, but comes to rest sooner than the east component; after about 15^h it seems to be dying down with very slight irregularities; whereas the east component experiences distinct disturbances up to 17^h 30^m. We could give almost the same description of the movement at Irkutsk if we interchanged components. This is curious, as the disturbance approaches the two stations in directions making about the same angle with the meridian. It is unfortunate that the instruments have so little damping that their proper motions persist for a long time and interfere with a better interpretation of the seismograms. For instance, it is impossible to say whether the prolonged strong motion of the north component at Jurjew is due to a continued strong disturbance or to the proper motion of the pendulum. The east component may have felt just as strong and long a disturbance but its large displacement may have been checked by it. We do not find this difference between the components of the strongly damped pendulum at Göttingen, which is but slightly further from the centrum.

The periods of the movement at Irkutsk are decidedly larger than at Jurjew; at the latter, during the first and second preliminary tremors the periods are about 30 seconds, very near the natural periods of the pendulums; at Irkutsk they are about 37 seconds and 50 seconds for the east and north components, respectively, in comparison with the natural periods of the pendulums of 25 and 35 seconds. During the large motion the east component did not record, and the north component is too irregular to determine a period, but both indicate comparatively large displacements of the ground.

The maximum displacements of the Bosch-Omori pendulums at Irkutsk seem entirely due to synchronism of periods and indicate a comparatively small earth amplitude, just the opposite of the indications of the Repsold-Zöllner pendulums. The beginning of the long waves is not apparent on the Zöllner instruments unless we take it at the beginning of the strong motion, but appears pretty well on the Bosch-Omori records, and the period is about 1 minute.

The times of arrival at Jurjew and Irkutsk are practically the same, indicating uniform velocities along the two paths followed.

POTSDAM, GERMANY.

Kgl. Preussisches Geodätisches Institut. Prof. Dr. O. Hecker, in charge of seismographs.

Lat. $52^{\circ} 53' N.$; long. $13^{\circ} 04' E.$; altitude, 90 meters; distance, 81.35° or 9,042 km.; chord, 8,303 km.; direction, $N. 25^{\circ} E.$

Foundation, sand.

The instruments used were:

Rebeur-Paschwitz pendulums, photographic registration. Seismograms, sheet No. 4.

(1) North and (2) East components: T_0 , 18 seconds; V , 36; J , 2,900 meters; ϵ , 2.5; M , 70 gm.; L , 9 cm. (?).

Wiechert inverted pendulum, two components; mechanical registration on smoked paper. Seismograms, sheet No. 5.

(3) North component: T_0 , 14 seconds; V , 133; J , 6,500 meters; ϵ 5; M , 1,000 kg.; L' , 49 meters.

(4) East component; T_0 , 14 seconds; V , 130; J , 6,350 meters; ϵ , 5; M , 1,000 kg.; L' , 49 meters.

	FIRST PRELIMINARY TREMORS.		SECOND PRELIMINARY TREMORS.		REGULAR WAVES.		PRINCIPAL PART.		MAX.		AMPLITUDE.		PERIOD.	
	<i>m.</i>	<i>s.</i>	<i>min.</i>		<i>min.</i>		<i>m.</i>	<i>s.</i>	<i>m.</i>	<i>s.</i>	<i>mm.</i>		<i>sec.</i>	
(1) North component	24	50	35.6		52.3		
(2) East component		52.0		60		23	
(3) North component	24	50	35	27	51	18	54	50	56	40	85 +		28	
(4) East component	24	51	35	05	51	40	54	50	56	07	80 +		28	
Average . . .	24	50	35	23	51	49	54	50						
Interval . . .	12	22	22	55	39	21	42	22						

Duration, 6 hours.

On account of the overlapping of the records on the seismogram of the East component of the Rebeur-Paschwitz instrument the beginning of the first two phases can not be made out. There was a shifting of the median lines at about 14^h , after which it exactly overlay the earlier line. The copyist has made the terminal part of the curve pass into the earlier part at about $15^h 33^m$ ($13^h 34^m$). The maximum amplitudes of the earth, as shown by the various instruments, approach the following values, tho the movements were not sufficiently regular to make the measures exact. (1) 1.7 mm.; (3) 2.7 mm.; (4) 2.2 mm. These maximums all occurred between $13^h 56^m$ and $13^h 57^m$. The recording point passed its limits and ceased to record on (4) at the time when the amplitude was measured. (3) indicates an earth-amplitude of 3.65 mm. at $13^h 53^m$, during the long waves; the east component at that time is not sufficiently regular to yield a measure, but the total value must be greater than 4.

GÖTTINGEN, GERMANY.

Geophysikalisches Institut der Universität. Prof. Dr. E. Wiechert, director.

Lat. $51^{\circ} 33' N.$; long. $9^{\circ} 58' E.$; altitude, 270 meters; distance, 81.36° or 9,046 km.; chord, 8,304 km.; direction, $N. 28^{\circ} E.$

Seismograms, sheet No. 12.

The instruments used, all having mechanical registration on smoked paper, were:

(1) Wiechert inverted pendulum, north component: T_0 , 1.48 seconds; L' , 0.543 meter; V , 2,100; J , 1,140 meters; ϵ , 8.0; r , 0.3 mm.; M , 17,000 kg.

Wiechert inverted pendulum, two components:

(2) North component: T_0 , 14.07 seconds; V , 152; J , 7,500 meters; ϵ , 3.9; r , 1.5 mm.; M , 1,200 kg.; L' , 49 meters.

(3) East component: T_0 , 12.6 seconds; V , 172; J , 6,700 meters; ϵ , 3.4; r , 0.9 mm.; M , 1,200 kg.; L' , 39.7 meters.

(4) Wiechert Vertical Motion Seismograph. T_0 , 4.8 seconds; V , 170; J , 970 meters; ϵ , 2.8; r , 0.1 mm.; M , 1,300 kg.; L' , 5.7 meters.

	FIRST PRELIMINARY TREMORS.		SECOND PRELIMINARY TREMORS.		REGULAR WAVES.		PRINCIPAL PART.			MAX.	AMPLITUDE.	PERIOD.	
	<i>m.</i>	<i>s.</i>	<i>m.</i>	<i>s.</i>	<i>m.</i>	<i>s.</i>	<i>m.</i>	<i>s.</i>	<i>min.</i>	<i>m.</i>	<i>s.</i>	<i>mm.</i>	<i>sec.</i>
(1) North component	24	55	35	15	51	10	57	55 to 07.0		59	20	18	20
(2) North component	24	44	34	52	51	..	56	00 to 06.0	48+	18	17
(3) East component	24	46	34	46	51	..	55	54 to 10.0	40+	18	17
(4) Vertical component	24	31	35	31	51	10	05	15	15	16
Average	24	44	35	06	51	05	56	36					
Interval	12	16	22	38	38	37	44	08					

During the long waves, at 13^h 54–54.5^m, we find the following earth-amplitudes indicated: (1) North, 0.8 mm.; (2) North, 0.97 mm.; (3) East, 1.31 mm.; (4) Vertical, 1.64 mm. at 13^h 52–53^m; probably the total would be about 2 mm. During the principal part: (1) North, 1.5 mm. at 13^h 59^m 20^s; (2) North, 0.53 mm.; (3) East, 0.52 mm.; (4) Vertical, 0.7 mm., at 14^h 06.5^m. (2) and (3) give too small values for the pendulum struck against the stops during the large part of the principal part. It is to be noticed, however, that (1) gives a larger and (4) a smaller amplitude than during the long waves. Probably the maximum during the principal part was a little greater than 2 mm.

COIMBRA, PORTUGAL.

Observatorio Magnetico-Meteorologico. Prof. A. S. Viegas, director.

Lat. 40° 12' N.; long. 8° 25' W.; altitude, 140.3 meters; distance, 81.39° or 9,049 km.; chord, 8,307 km.; direction, N. 45° E.

Foundation, Triassic sandstone.

Seismograms, sheet No. 1.

The instrument used was a Milne horizontal pendulum, east component; photographic registration; V , 6.1; M , 255 gm.

	FIRST PRELIMINARY TREMORS.	SECOND PRELIMINARY TREMORS.	REGULAR WAVES.	MAX.	AMPLITUDE.
	<i>min.</i>	<i>min.</i>	<i>min.</i>	<i>m.</i> <i>s.</i>	<i>mm.</i>
East component	25.4	35.0	50.5	55 58	16
Interval	12.9	22.5	38.0		

Duration, 3 hours. During the strong motion the period of the waves was about 24 seconds; the proper period of the pendulum is not known and the actual magnification can not be determined.

LEIPZIG, GERMANY.

Kgl. Geologisches Bureau. Prof. Dr. Hermann Credner, director; Dr. F. Etwold, assistant.

Lat. 51° 20' N.; long. 12° 23.5' E.; distance, 82.40° or 9,161 km.; chord, 8,392 km.; direction, N. 26° E.

Foundation, alluvium and sands.

The instrument used was a Wiechert inverted pendulum, two components; mechanical registration on smoked paper.

(1) North component: T_0 , 8.5 seconds; V , 220.6; J , 4,000 meters; ϵ , 3.05; M , 1,100 kg.; L' , 18.1 meters.

(2) East component: T_0 , 8.5 seconds; V , 241; J , 4,350 meters; ϵ , 2.4; M , 1,100 kg.; L' , 18.1 meters.

	FIRST PRELIMINARY TREMORS.		SECOND PRELIMINARY TREMORS.		REGULAR WAVES.	PRINCIPAL PART.	MAX.	AMPLITUDE.	PERIOD.	EARTH'S AMPLITUDE.	
	<i>m.</i>	<i>s.</i>	<i>m.</i>	<i>s.</i>	<i>m.</i>	<i>s.</i>	<i>min.</i>	<i>mm.</i>	<i>sec.</i>	<i>mm.</i>	
(1) North component	24	50	35	39	51	09	56.0 to 06.3	$\left. \begin{array}{l} 57.8 \\ 05.9 \end{array} \right\}$	$\left. \begin{array}{l} 24 \\ 34 \end{array} \right\}$	$\left. \begin{array}{l} 21 \\ 17 \end{array} \right\}$	$\left. \begin{array}{l} 0.59 \\ 0.51 \end{array} \right\}$
(2) East component	24	50	35	39	51	34	55.0 to 06.5	$\left. \begin{array}{l} 55 \quad 41 \\ 57 \quad 28 \end{array} \right\}$	$\left. \begin{array}{l} 64+ \\ 64+ \end{array} \right\}$	$\left. \begin{array}{l} 26 \\ 22 \end{array} \right\}$	$\left. \begin{array}{l} 1.81 + \\ 1.55 + \end{array} \right\}$
Average . . .	24	50	35	39	51	21	55 30				
Interval . . .	12	22	23	11	38	53	43 02				

Duration, 4.4 hours. At 13^h 54^m the long waves of north component had a period of about 40 seconds and an amplitude of 10 mm. This gives an amplitude on the north component of the earth-movement of about 1 mm.; at the same time the east component indicates an earth-amplitude of 1.2 mm., and the total may be 1.5 mm. At 13^h 55^m 41^s, the east earth-amplitude is 1.81 mm. and the combined amplitude is 2.17 mm. At 13^h 57.5^m the north earth component is 0.58 and east component 1.55; total 1.65 mm. These amplitudes are not entirely trustworthy, because at times the instrument reached its limit and the motion was not very regular. At Plauen, a substation of Leipzig, and 90 km. to the south, the record resembled that at Leipzig.

The seismogram from Leipzig is reproduced in "Siebenter Bericht der Erdbebenstation Leipzig" (Ber. der Math. Phys. Kl. d. Kön. Sächsischen Gesells. d. Wissens. zu Leipzig. Bd. LIX, January 14, 1907). A copy of this was forwarded by Dr. Credner, but the seismogram was overlooked, and therefore is not reproduced in the atlas.

JENA, GERMANY.

Sternwarte. Prof. Dr. Rudolph Straubel, director; Dr. Eppenstein, assistant.

Lat. 50° 56' N.; long. 11° 35' E.; altitude, 155 meters; distance, 82.45° or 9,167 km.; chord, 8,396 km.; direction, N. 27° E.

Foundation, in the valley of the Saale River, on 4 to 5 meters of weathered sandstone, underlain by the Bunt sandstone.

Seismograms, sheet No. 11.

The instrument used was a Wiechert inverted pendulum, two components; mechanical registration on smoked paper.

(1) North component: T_0 , 11.6 seconds; V , 160; J , 5,300 meters; ϵ , 5.0; M , 1,200 kg.; L' , 33.6 meters.

(2) East component: T_0 , 11.6 seconds; V , 180; J , 6,000; ϵ , 5.0; M , 1,200 kg.; L' , 33.6 meters.

	FIRST PRELIMINARY TREMORS.		SECOND PRELIMINARY TREMORS.		REGULAR WAVES.	PRINCIPAL PART.	MAX.	AMPLITUDE.
	<i>m.</i>	<i>s.</i>	<i>m.</i>	<i>s.</i>	<i>min.</i>	<i>min.</i>	<i>min.</i>	<i>mm.</i>
(1) North component	24	34	35	09	51.2	56.5 to 07.5	55.0 to 59.0	..
(2) East component	24	34	35	09	51.2	56.8	58.0 to 00.	80 +
Average . . .	24	34	35	09	51 12	56 39		
Interval . . .	12	06	22	41	38 44	44 11		

Duration, 5.6 hours. From 54 to 56^m, during the long waves the earth's amplitudes were the largest, being 2.6 mm. for the north and 1.9 mm. for the east component, a possible total of 3.2 mm. At about 59^m the indicated earth's amplitudes are 2.0 mm. and 1.5 mm. for north and east components, respectively, and with a possible total of 2.5 mm.; but this is undoubtedly too small, as the instruments reached the stops.

STRASSBURG, GERMANY.

Kais. Hauptstation für Erdbebenforschung. Prof. Dr. G. Gerland, director; Dr. E. Rudolph, assistant.

Lat. 48° 35' N.; long. 7° 46' E.; altitude, 135 meters; distance, 82.91° or 9,218 km.; chord, 8,434 km.; direction, N. 30° E.

Foundation, compact alluvial gravel.

Seismograms, sheet No. 14.

The instruments used were:

Rebeur-Ehlert triple pendulums, No. 2, two components; photographic registration.¹

(1) N. 30° E. component; (2) E. component; T_0 , 10 seconds; V , 45; J , 1,120 meters.

(3) Omori horizontal pendulum, east component.

Vicentini microseismograph, three components; mechanical registration on smoked paper.

(4) North and (5) east components. (6) Vertical component; V , 85; no damping and very slight friction.

(7) Schmidt trifilargravimeter.

	FIRST PRELIMINARY TREMORS.		SECOND PRELIMINARY TREMORS.		REGULAR WAVES.	PRINCIPAL PART.	MAX.	AMPLITUDE.	PERIOD.	EARTH'S AMPLITUDE.
	m.	s.	m.	s.	min.	min.	m. s.	mm.	sec.	mm.
(1) N. 30° E. component	24	52	35	18	51.2?	58.0	02 39	16.5	16	0.59
(2) East component .	25	06	35	28	m. s. 46 13	.. .	01 19	7.0	20	0.47
(3) East component .	24	51	35	17	46 36	.. .	07 27	4.4	12	
(4) North component	48	.. .	01 25	2.0	22	
(5) East component .	24	53	35	18	46 05	.. .	02 35	2.0	18	
(6) Vertical compent .	25	12	52	.. .	05 20	0.3	14	
(7) Vertical component	24	43	50 31	.. .	02 31	1.3	16	
Average	24	57	35	20						
Interval	12	29	22	52						

Duration, Rebeur, 2.5 to 3.5 hours; Omori, Vicentini, Schmidt, 1 to 2 hours. The possible maximum earth-amplitude is about 0.75 mm., according to the record of the Rebeur-Ehlert instrument.

The times, amplitudes, and periods are taken from the "Wöchentliches Erdbebenbericht der Kais. Hauptstation für Erdbebenforschung zur Strassburg," with the exception of the long waves, principal part and maximum of (1), which were obtained from the seismogram. It is evident that the various times under regular waves do not refer to the same phase.

MOSCOW, RUSSIA.

Imperial University. Dr. Ernest Leyst, in charge of seismographs.

Lat. 55° 45' N.; long. 37° 34' E.; distance, 84.72° or 9,419 km.; chord, 8,584 km.; direction, N. 11° E.

Foundation, sand.

¹The constants of these instruments are taken from the text accompanying "Seismogramme de nordpazifischen und sudamerikanischen Erdbebens am 16 August, 1906," a publication of the International Seismological Association. They probably also apply to April 18, 1906.

The instruments used were Bosch-Omori horizontal pendulums, two components; mechanical registration on smoked paper.

(1) North and (2) east components: T_0 , 60 seconds; M , 10 kg.; L , 75 cm.¹

	FIRST PRELIMINARY TREMORS.	PRINCIPAL PART.	MAX.	AMPLITUDE.
	<i>min.</i>	<i>min.</i>	<i>min.</i>	<i>mm.</i>
(1) North component .	28	57 to 12	59 to 01	150 + ²
(2) East component .	51	54 to 04	57 to 03	150 + ²

MUNICH, GERMANY.

Kgl. Observatorium für Erdmagnetismus und Erdbebenstation. Dr. J. B. Messerschmitt, director.

Lat. 48° 09' N.; long. 11° 36.5' E.; altitude, 530 meters; distance, 84.75° or 9,423 km.; chord, 8,587 km.; direction, N. 29° E.

Seismograms, sheet No. 5.

The instrument used was a Wiechert inverted pendulum.

(1) North and (2) east components: T_0 , 12.1 seconds; V , 200; J , 7,300 meters; ϵ , 6.0; M , 1,000 kg.; L' , 36.6 meters.

	FIRST PRELIMINARY TREMORS.		SECOND PRELIMINARY TREMORS.		REGULAR WAVES.		MAX.	AMPLITUDE.	PERIOD.	EARTH'S AMPLITUDE.
	<i>m.</i>	<i>s.</i>	<i>m.</i>	<i>s.</i>	<i>m.</i>	<i>s.</i>	<i>min.</i>	<i>mm.</i>	<i>sec.</i>	<i>mm.</i>
(1) North component	25	00	35	26	52	00	04	80 +	?	..
(2) East component	25	00	35	41	51	26	58	80 +	20	0.8 +
Average . . .	25	00	35	34	51	43				
Interval . . .	12	32	23	06	39	15				

At 13^h 52^m the north component of the earth's movement is 0.47 mm., and the east component 1.26; a possible total of 1.35 mm.; this is during the long waves. During the principal part at 13^h 58^m, the east indicator went beyond the limits, indicating an earth-amplitude of more than 1.25 mm.; at the same time the north indicator showed an earth-amplitude of 0.77 mm.; that is, the total amplitude was possibly greater than 1.47 mm. At 14^h 05^m the north indicator exceeded the limits; and after that time no further record was made.

It is possible that the regular waves should be put about 4 minutes earlier; but the phase here taken is evidently the same as that taken for the regular waves at Jena.

SAN FERNANDO, SPAIN.

Instituto y Observatorio de Marina. Capitan Thomas de Azcarate, director.

Lat. 36° 28' N.; long. 6° 12' W.; altitude, 28 meters; distance, 85.25° or 9,478 km.; chord, 8,628 km.; direction, N. 46° E.

Foundation, solid rock.

Seismograms, sheet No. 1.

The instrument used was a Milne horizontal pendulum, east component; photographic registration; T_0 , 20 seconds; V , 6.1; J , 600 meters; ϵ , 1.13; M , 255 gm.; L , 15.6 cm.

¹ The times at Moscow are taken from an article by Dr. E. Leyst in the Bulletin of the Naturalists of Moscow, Nos. 1 and 2, 1906. They are given to minutes only. It is evident that the beginning was not recorded, and the identification of the phases actually recorded is uncertain.

² Off paper.

	FIRST PRELIMINARY TREMORS.	SECOND PRELIMINARY TREMORS.	REGULAR WAVES.	MAX.	AMPLITUDE.
	<i>min.</i>	<i>min.</i>	<i>min.</i>	<i>min.</i>	<i>mm.</i>
East component	25.1	35.3	48.5 or 53.7	} 57.9 } 04.2	17.5 +
Interval	12.6	22.8	36.0 or 41.5		17.5 +

The identification of the beginning of the regular waves is very doubtful.

TORTOSA, SPAIN.

Observatorio del Ebro. P. R. Cirera, S. J., director.

Lat. 40° 49' N.; long. 0° 30' E.; altitude, 38 meters; distance, 85.65° or 9,522 km.;
chord, 8,660 km.; direction, N. 39° E.

Foundation, solid rock; cretaceous strata.

The instrument used was a Vicentini microseismograph, two horizontal components; mechanical registration on smoked paper. T_0 , 1.8 seconds; V , 180; J , 1,450 meters; M , 100 kg.; L , 1.43 meters.

	FIRST PRELIMINARY TREMORS.	SECOND PRELIMINARY TREMORS.	REGULAR WAVES.	MAX.	AMPLITUDE.	PERIOD.	EARTH'S AMPLITUDE.
	<i>m.</i> <i>s.</i>	<i>m.</i> <i>s.</i>	<i>m.</i> <i>s.</i>	<i>min.</i>	<i>mm.</i>	<i>sec.</i>	<i>mm.</i>
Average	24 55	36 00	55 00	18.0	3	16.4	1.36
Interval	12 27	23 32	42 32				

Duration, 2.5 hours. If both components have the same maximum amplitude at the same time, the total earth-amplitude might be 1.82 mm.

KREMSMÜNSTER, AUSTRIA.

Observatoire des Benedictines. P. Franz Schwab, director.

Lat. 48° 03' N.; long. 14° 08' E.; altitude, 380 meters; distance, 85.77° or 9,535 km.;
chord, 8,670 km.; direction, N. 27° E.

Foundation, about 20 meters of glacial till lying on Tertiary strata.

Seismograms, sheet No. 2.¹

The instruments used were Ehlert horizontal pendulums (triple); photographic registration.

(1) N. 13° W. component: T_0 , 10 seconds; V , 81.4; J , 2,000 meters; ϵ , 1.0; L , 10 cm.

(2) N. 47° E. component: T_0 , 10 seconds; V , 76.7; J , 1,900 meters; ϵ , 1.0; L , 10 cm.

(3) N. 73° W. component: T_0 , 10 seconds; V , 81.4; J , 2,000 meters; ϵ , 1.0; L , 10 cm.

	FIRST PRELIMINARY TREMORS.	SECOND PRELIMINARY TREMORS.	PRINCIPAL PART.	MAX.	AMPLITUDE.
	<i>min.</i>	<i>min.</i>	<i>min.</i>	<i>min.</i>	<i>mm.</i>
(1) N. 13° W. component	24.4	38.3?	01.9?	} 37.5 } 06.8	13 18
(2) N. 47° E. component	24.4	35.5	49.1?		} 39.1 } 01.6 } 05.8
(3) N. 73° W. component	24.4	} 40.8 } 00.2 } 05.8	
Average	24.4	35.5			
Interval	11.9	23.0			

¹ The middle record of the seismogram records the N. 47° E. component of the motion and not the N. 47° W. component as indicated.

Duration, 1.8 hours. The three Ehlert pendulums give very different effects. They all begin at closely the same time but the second group is well shown only on (2), the instrument which records the northeast movement, that is, at right angles to the direction of propagation; this indicates a transverse wave. It can be recognized on (1), recording the north-northwest component, at 38.3^m, but not so clearly. The beginning of the regular waves is not recognizable; nor can we be sure of the time of beginning of the principal part.

The lines just below the seismograms are the records of a different hour.

KRAKAU, AUSTRIA.

K. K. Sternwarte, Prof. Dr. M. F. Rudski, director.

Lat. 50° 04' N.; long. 19° 58' E.; altitude, 205 meters; distance, 85.98° or 9,558 km.; chord, 8,687 km.; direction, N. 23° E.

Foundation, compact sandy clay alluvium.

Seismograms, sheet No. 13.

The instruments used were Bosch-Omori horizontal pendulums, two components; mechanical registration on smoked paper.

(1) Northwest component: T_0 , 31.2 seconds; V , 10; J , 2,400 meters; ϵ , 1.0 (?); r , 2.8 mm. (?); M , 11 kg.; L , 75 cm.

(2) Northeast component: T_0 , 25.8 seconds; V , 9.6; J , 1,600 meters; ϵ , 1.24 (?); r , 2.1 mm. (?); M , 11 kg.; L , 75 cm.

	SECOND PRELIMINARY TREMORS.	REGULAR WAVES.	PRINCIPAL PART.	MAX.	AMPLI- TUDE.	PERIOD.
	<i>min.</i>	<i>min.</i>	<i>min.</i>	<i>min.</i>	<i>mm.</i>	<i>sec.</i>
(1) Northwest component	35.8	54.5	57.1	00.9	20	32
(2) Northeast component	35.6	53.6	58.0	59.2	55	24
Average	<i>m.</i> <i>s.</i>	<i>m.</i> <i>s.</i>	<i>m.</i> <i>s.</i>			
Interval	35 42	54 06	57 33?			
	23 14	41 38	45 07?			

Duration, northwest, 2.3 hours; northeast, 1.8 hours.

The beginning of the disturbance was not registered, tho very slight movements can be made out on the northwest component about 13^h 27^m; they are very slight and would not be recognized unless especially lookt for. The early motion (second preliminary tremors) is somewhat larger in the northwest than in the northeast component, indicating longitudinal waves; but this may be due to friction in the latter component. It is not entirely clear why the first preliminary tremors were not properly registered; the seismograms show that the northeast component had strong, solid friction which would be sufficient to prevent it from registering very small disturbances; but this condition is not so evident in the northwest component.

Dr. Rudski only gives the times to tenths of minutes on account of the uncertainty of the beginning of the different phases; but the clock-time is perfect. The periods during the strong motion are so close to the natural periods of the pendulum that we can not make a good determination of the earth's movement. The values of the damping ratios and the solid friction are determined from observations made long before the date of the earthquake.

GRANADA, SPAIN.

Observatorio de Cartuja. P. S. Navarro-Neumann, S. J., director.

Lat. 37° 11' N.; long. 3° 48' W.; altitude, 776 meters; distance, 86.08° or 9,570 km.; chord, 8,696 km.; direction, N. 44° E.

Foundation, piers are directly on Tertiary limestone.

Seismograms, sheet No. 14.

The instruments used were:

(1) Stiattesi horizontal pendulum, east component; mechanical registration on smoked paper. T_0 , 17.6 seconds; V , 25; J , 1,900 meters; M , 208 kg.; L , 1.75 meters.

(2) Vicentini microseismograph, east component; mechanical registration on smoked paper. T_0 , 3.4 seconds; V , 155; J , 450 meters; M , 312 kg.; L , 2.88 meters.

	FIRST PRELIMINARY TREMORS.		SECOND PRELIMINARY TREMORS.		REGULAR WAVES.		PRINCIPAL PART.		MAX.	AMPLITUDE.	PERIOD.	EARTH'S AMPLITUDE.
	m.	s.	m.	s.	m.	s.	min.					
(1) East component	24	40	35	20	48	09	54.6 to 11.0		{ 58.0 { 05.8 { 08.5 { 55.2 { 57.2	46 +	17.6	...
(2) East component	24	40	35	20	54.7 to 11.0			28.1	4.2	1.8
Average . . .	24	40	35	20	48	09	m. s. 54 39			16.7	4.0	0.6
Interval . . .	12	12	22	52	35	31	42 11					

Duration, 5.5 hours. The time of the regular waves is taken a little later than the time marked on the seismogram; it is evident that what is here taken for the beginning of the principal part is that of the regular waves on the Krakau, the Pavia, and the Vienna seismograms; it is accordingly so considered in the determination of velocity of propagation.

PAVIA, ITALY.

R. Osservatorio Geofisico. Dr. P. Gamba, director.

Lat. 45° 11' N.; long. 9° 10' E.; altitude, 81.7 meters; distance, 86.20° or 9,583 km.; chord, 8,707 km.; direction, N. 32° E.

Foundation, Quarternary alluvium, about 200 meters thick.

Seismograms, sheet No. 7.

The instrument used was an Agamennone vertical pendulum, two horizontal components; mechanical registration with ink on paper.

(1) Northeast component: T_0 , 6 seconds; V , 20; J , 180 meters; ϵ , 1.14; r , 0.38 mm.; M , 200 kg.; L , 8.96 meters.

(2) Southeast component: T_0 , 6 seconds; V , 20; J , 180 meters; ϵ , 1.52; r , 1.05 mm.; M , 200 kg.; L , 8.96 meters.

	FIRST PRELIMINARY TREMORS.		SECOND PRELIMINARY TREMORS.		REGULAR WAVES.		PRINCIPAL PART.		MAX.	AMPLITUDE.	PERIOD.	EARTH'S AMPLITUDE.
	m.	s.	m.	s.	m.	s.	m. s. m. s.					
(1) Northeast component	25	06	35	06	54	00	59 20 to 08 40		04 25	8.0	15	4.0
(2) Southeast component	24	46	02 30 to 08 30		{ 03 15 { 06 25	10.0	16.0	5.0
Average	24	56	35	06	54	00	00 55?			9.5	13.8	3.0
Interval	12	28	22	38	41	32	48 27?					

Duration, 2+ hours. The second group begins more sharply in the northeast than in the northwest component, *i.e.*, at right angles to the direction of propagation. The long waves are also better marked on this component and the principal part begins earlier and lasts longer, tho it has a slightly greater maximum on the other component. This is probably not a question of period, as both components have the same; but the less well-defined record of the southeast component is probably in part due to the greater friction; its value of r is more than twice that of the other component.

The period of the regular waves on the northeast component at 13^h 56^m is about 27 seconds; and amplitude 2.8 mm.; indicating an earth-amplitude of 2.7 mm. An earth-amplitude of 2.2 mm. is the maximum on the northeast component at 14^h 04.4^m; both of these maxima occur at times of minima on the northwest component. An earth-amplitude of 3 mm. is shown on the southeast component at 14^h 03^m; at this time the earth-amplitude on the northeast component is only about 1 mm., so that the total amplitude may be 3.3 mm.

VIENNA, AUSTRIA.

K. K. Zentralanstalt für Meteorologie und Geodynamik. Prof. Dr. J. M. Pernter, director.

Lat. 48° 15' N.; long. 16° 21.5' E.; altitude, 200 meters; distance, 86.37° or 9,602 km.; chord, 8,719 km.; direction, N. 26° E.

Foundation, loam soil.

Seismograms, sheet No. 9.

The instrument used was a Wiechert inverted pendulum, two components; mechanical registration on smoked paper.

(1) North and (2) east components: T_0 , 14 seconds; V , 250; J , 12,500 meters; ϵ , 2.0; M , 1,000 kg.; L' , 49 meters.

	FIRST PRELIMINARY TREMORS.		SECOND PRELIMINARY TREMORS.		REGULAR WAVES.		PRINCIPAL PART.	MAX.	AMPLITUDE.	PERIOD.	EARTH'S AMPLITUDE.	
	<i>m.</i>	<i>s.</i>	<i>m.</i>	<i>s.</i>	<i>m.</i>	<i>s.</i>	<i>min.</i>	<i>m.</i>	<i>s.</i>	<i>mm.</i>	<i>sec.</i>	<i>mm.</i>
(1) North component .	25	15	36	08	53	58	58.0 to 11.5	08	00	35	18.8	0.11
(2) East component .	25	15	36	09	53	24	57.1	59	35	30	23.4	0.23
Average	25	15	36	08	53	41	<i>m.</i> <i>s.</i> 57 33					
Interval	12	47	23	40	41	13	45 05					

Duration, 2.7 hours. The times of arrival of the regular waves is difficult to determine; it is possible, but not probable, that they should be taken about 6 minutes later. Tho the second group are also slightly questionable, the time given is probably correct. The earth-amplitude was slightly larger for the east component; it was 0.21 mm. at 13^h 59.5^m against 0.09 mm. for the north component; it was 0.14 mm. at 14^h 04.5^m, 14^h 06.5^m, and 14^h 08^m; and for the north component it was 0.19 mm. at 13^h 58.5^m and 0.13 mm. at 14^h 08^m.

SALÒ (BRESCIA), ITALY.

Osservatorio Geodinamico. Signor P. Bettoni, director.

Lat. 45° 36' N.; long. 10° 30' E.; distance, 86.42° or 9,608 km.; chord, 8,722 km.; direction, N. 31° E.

The instrument used was an Agamennone seismometrograph, northeast and northwest components; mechanical registration with ink on white paper. T_0 , 7.8 seconds; V , 10; J , 150 meters; M , 220 kg.

A very faint movement is discernible at 13^h 52^m, which reaches a maximum of 2 mm. amplitude at 14^h 05^m on the northeast component. The greatest amplitude on the northwest component is only 0.2 mm. The transverse waves are therefore much stronger than the longitudinal. Earth-amplitudes can not be determined. The seismogram arrived too late for insertion in the atlas.

LAIBACH, AUSTRIA.

Erdbebenwarte. Prof. Dr. A. Belar, director.

Lat. 46° 03' N.; long. 14° 31' E.; distance, 87.22° or 9,697 km.; chord, 8,786 km.; direction, N. 29° E.

The instruments used were:

Ehlert triple pendulums, three components; photographic registration.

(1) North component: T_0 , 3 seconds.

(2) East component: T_0 , 7 seconds.

(3) Northeast component: T_0 , 12 seconds.

Horizontal pendulum, two components.

(4) Northeast and (5) northwest components: this instrument consists of a box containing 40 kg. of stone pressing against a steel point and supported by a long wire; registration with ink on white paper; T_0 , 20 seconds; V , 11; M , 40 kg.

Vicentini microseismograph; registration on smoked paper.

(6) North, (7) east, and (8) vertical components; V , 100.

Seismograph (construction not known).

(9) North and (10) east components; V , 12.6.

	FIRST PRELIMINARY TREMORS.		SECOND PRELIMINARY TREMORS.		PRINCIPAL PART.		MAX.		AMPLITUDE.	PERIOD.
	<i>m.</i>	<i>s.</i>	<i>m.</i>	<i>s.</i>	<i>m.</i>	<i>s.</i>	<i>m.</i>	<i>s.</i>	<i>mm.</i>	<i>sec.</i>
(1) North component . .	25	25	35	38
(2) East component . . .	25	37	35	30	54	21 to 11	08	59	47	25
(3) Northeast component .	25	30	35	21	54	10 to 10	00	59	52	30
(4) Northeast component ¹	26	52	36	47	52	17 to 11	20	02	42	5.5
(5) Northwest component ¹	26	31	36	25	52	38 to 11	32	02	52	6
(6) North component . . .	25	36	35	31	53	56 to 11	03	59	55	3.7
(7) East component . . .	25	34	35	29	54	09 to 10	57	59	52	3.0
(8) Vertical component . .	25	37	35	32	54	15 to 12	00	00	02	1.0
(9) North component . . .	25	37
(10) East component . . .	25	38
Average	25	34	35	30	54	10				
Interval	13	06	23	02	41	42				

TRIEST, AUSTRIA.

K. K. Maritimes Observatorium. Prof. Dr. Edu. Mazelle, director.

Lat. 45° 34' N.; long. 13° 46' E.; altitude, 67.5 meters; distance, 87.74° or 9,754 km.; chord, 8,828 km.; direction, N. 29° E.

Foundation, rock.

The instruments used were:

Ehlert horizontal pendulums (triple); photographic registration.

(1) North component: T_0 , 12 seconds; V , 88; J , 3,150 meters; L' , 35.8 meters; M , 200 (?) gm.; L , 9.9 cm.

(2) N. 60° W. component: T_0 , 14 seconds; V , 84; J , 4,100 meters; M , 200 (?) gm.; L , 9.9 cm.

(3) N. 60° E. component: T_0 , 18 seconds; V , 88; J , 7,100 meters; L' , 80.7 meters; M , 200 (?) gm.; L , 9.9 cm.

Vicentini microseismograph, three components; mechanical registration on smoked paper.

(4) North and (5) east components: T_0 , 2.41 seconds; V , 100; J , 143 meters; M , 100 kg.; L , 1.43 meters.

¹ The records of this instrument were not used in making up the average, as they differ so materially from the others.

(6) Vertical component: T_0 , 0.95 seconds; V , 100; J , 22.5 meters; M , 45 kg.; L , 1.50 meters.

	FIRST PRELIMINARY TREMORS.		SECOND PRELIMINARY TREMORS.		REGULAR WAVES.		MAX.	AMPLI- TUDE.	PERIOD.
	<i>m.</i>	<i>s.</i>	<i>m.</i>	<i>s.</i>	<i>m.</i>	<i>s.</i>	<i>min.</i>	<i>mm.</i>	<i>sec.</i>
(1) North component . . .	24	33	35	03	04.6	22	...
(2) N. 60° W. component	25	28	35	34	05.8	40	...
(3) N. 60° E. component .	25	11	35	18	05.4	28	...
(4) North component . . .	25	26	35	47	45	30	05.7	2.0	18
(5) East component	36	18	49	31	03.0	1.5	18.9
(6) Vertical component	05.7	0.5	17.5
Average	25	09	35	36					
Interval	12	41	23	08					

Duration, Ehlert, 3 hours; Vicentini, 2 hours. The movement on the vertical component began at 02^m 51^s with reinforcement at 05^m 18^s. The seismograms of the Vicentini instrument were too faint to reproduce, but we can determine from them the movements of the earth. At 14^h 05.7^m the earth's amplitude was: North, 1.1 mm.; east, 0.1 mm.; vertical, 0.9; total, 1.4 mm. At 14^h 03^m: North, 1.03; east, 0.9; vertical, 0; total, 1.4 mm. These amplitudes should be a little larger, as the seismograms from which they were determined were slightly reduced.

BUDAPEST, HUNGARY.

Seismological Observatory of the University. Prof. Dr. R. de Kovesligethy, director.
Lat. 47° 29.5' N.; long. 19° 04' W.; altitude, 110 meters; distance, 87.93° or 9,777 km.;
chord, 8,846 km.; direction, N. 25° E.

Foundation, alluvium on Tertiary strata.

The instruments used were:

Bosch-Omori horizontal pendulum, north component: T_0 , 23 seconds; V , 9; J , 1,190 meters; M , 10 kg.; L , 75 cm.

Vicentini-Konkoly vertical pendulum.

North component: T_0 , 2.45 seconds; V , 44; J , 66 meters; M , 105 kg.; L , 1.5 meters.

East component: T_0 , 2.45 seconds; V , 60; J , 90 meters; M , 105 kg.; L , 1.5 meters.

The clock controlling the time marks was not working, so that no time records were made; but the "Bulletin hebdomadaire des observatoires sismiques de la Hongrie et de la Croatie" gives the maximum amplitudes and the corresponding periods of the waves, which enables us to calculate the earth-amplitudes when the instruments recorded a maximum. We have:

Bosch-Omori, north component: amplitude, 22.3 mm.; period, 15 seconds; earth's amplitude, 1.42 mm.

Vicentini-Konkoly, north component: amplitude, 1.0 mm.; period, 26 seconds; earth's amplitude, 2.5 mm.

Vicentini-Konkoly, east component: amplitude, 0.55 mm.; period, 26 seconds; earth's amplitude, 1.06 mm.

O'GYALLA, HUNGARY.

Seismological, Meteorological, and Geodynamic Observatory. Dr. N. Thege von Konkoly, director.

Lat. 47° 52' N.; long. 18° 12' E.; altitude, 111 meters; distance, 88.08° or 9,792 km.;
chord, 8,856 km.; direction, N. 25° E.

Foundation, on a sandy plain.

The instruments used were:

Bosch-Omori horizontal pendulums, two components; mechanical registration on smoked paper.

(1) North component: T_0 , 23 seconds; V , 10; J , 1,300 meters; ϵ , 1.17; M , 11 kg.; L , 75 cm.

(2) East component: T_0 , 21 seconds; V , 10; J , 1,050 meters; ϵ , 1.17; M , 11 kg.; L , 75 cm.

Vicentini-Konkoly vertical pendulum, two components; mechanical registration on smoked paper.

(3) North component: T_0 , 2.5 seconds; V , 41; J , 64 meters; ϵ , 1.105; M , 105 kg.; L , 1.55 meters.

(4) East component: T_0 , 2.5 seconds; V , 49; J , 76 meters; ϵ , 1.105; M , 105 kg.; L , 1.15 meters.

	FIRST PRELIMINARY TREMORS.		SECOND PRELIMINARY TREMORS.		PRINCIPAL PART.		MAX.	PERIOD.	AMPLITUDE.	EARTH'S AMPLITUDE.	
	<i>m.</i>	<i>s.</i>	<i>m.</i>	<i>s.</i>	<i>m.</i>	<i>s.</i>	<i>m.</i>	<i>s.</i>	<i>sec.</i>	<i>mm.</i>	<i>mm.</i>
(1) North component .	25	12	35	57	54	18	00	21	20	55 +	1.4
(2) East component .	25	28	36	20	52	59	06	32	18	43	1.26
(3) North component	56	44?	02	01	17	0.3	0.33
(4) East component	51	24	00	32	19	0.55	0.64
Average	25	20	36	08							
Interval	12	52	23	40							

Duration, (1) 2 hours; (2) 1.8 hours; (3) 36 minutes; (4) 54 minutes. There is little concordance in the times of the principal part, and in the absence of the seismograms these values can not be used in the determination of the velocity.

The times, periods, and amplitudes are taken from the "Bulletin hebdomadaire des observatoires sismiques de la Hongrie et de la Croatie"; and the earth-amplitudes are calculated. The smaller amplitudes of the Vicentini instrument are probably more reliable than those of the Bosch-Omori instrument, for the period of the latter is so nearly that of the waves that its magnifying power is very uncertain. On the other hand the Vicentini failed to record the first and second preliminary tremors, indicating a lack of sensitiveness, possibly due to friction.

The Vicentini instrument at Zagreb, 30 km. further from the origin than O'Gyalla, indicates much larger amplitudes, but they also are very uncertain.

FIUME, HUNGARY.

Seismological Observatory. Dr. P. Salcher, director.

Lat. $45^{\circ} 20'$ N.; long. $14^{\circ} 26'$ E.; altitude, 20 meters; distance, 88.17° or 9,802 km.; chord, 8,863 km.; direction, N. 29° E.

Foundation, folded Cretaceous limestones.

The instrument used was a Vicentini-Konkoly pendulum, two components; mechanical registration on smoked paper. V , 86; M , 100 kg.; L , $1.70 \pm$ meters. The movement begins on both components (north and east) at $13^{\text{h}} 40^{\text{m}}$ and reaches a maximum, north $54^{\text{m}} 18^{\text{s}}$, amplitude 0.8 mm.; east, $55^{\text{m}} 18^{\text{s}}$, amplitude 1.5 mm. The disturbance lasted 27.5 and 47 minutes, respectively, on the north and east components. It is not clear what phase the beginning of the movement refers to.

FLORENCE (XIMENIANO), ITALY.

Osservatorio Ximeniano. P. G. Alfani, S. J., director.

Lat. $43^{\circ} 47' N.$; long. $11^{\circ} 15' E.$; distance, 88.23° or 9,808 km.; chord, 8,868 km.; direction, $N. 31^{\circ} E.$

Foundation, alluvium.

Seismograms, sheet No. 6.

The instruments used were:

Stiattesi horizontal pendulums. (1) North and (2) east components: T_0 , 40 seconds; V , 30; J , 12,000 meters; M , 500 kg.; L , 1.50 meters.

Vicentini microseismograph. (3) North and east components: T_0 , 2.4 seconds; V , 100; J , 143 meters; M , 450 kg.; L , 1.43 meters.

Omori tromometrograph. (4) Northeast and (5) northwest components: T_0 , 36 seconds; V , 25; J , 8,100 meters; M , 250 kg.; L , 50 cm.

All have mechanical registration on smoked paper.

	FIRST PRELIMINARY TREMORS.		SECOND PRELIMINARY TREMORS.		PRINCIPAL PART.		MAX.	AMPLITUDE.	PERIOD.	EARTH'S AMPLITUDE.
	<i>m.</i>	<i>s.</i>	<i>m.</i>	<i>s.</i>	<i>m.</i>	<i>s.</i>	<i>min.</i>	<i>mm.</i>	<i>sec.</i>	<i>mm.</i>
(1) North component . . .	26	25	37	15	49	20	10.0	135 +	17.6	4.1 +
(2) East component . . .	26	25	37	20	45	10	07.0	100 +	17.6	2.6 +
(3) North and east components	26	25	37	05	56	00	<i>m. s.</i> 59 50
(4) Northeast components . .	26	25	36	55	48	15	10 55	75	19	2.8
(5) Northwest component . .	26	25	36	45	47	25	08 05	100	22	1.9
Average	26	25	37	04						
Interval	13	57	24	36						

There are no time marks on the record of the Omori instruments, (4) and (5). Assuming the time of beginning to be the same as that given by the other instruments, the times of the later phases are obtained from the rate of rotation of the recording drum.

ZAGREB (AGRAM), HUNGARY.

Seismological Observatory. Prof. Dr. Mohorovicsics.

Lat. $45^{\circ} 49' N.$; long. $15^{\circ} 59' E.$; distance, 88.33° or 9,820 km.; chord, 8,877 km.; direction, $N. 27^{\circ} E.$

The instrument used was a Vicentini-Konkoly vertical pendulum, two horizontal components; mechanical registration on smoked paper. (1) North and (2) east components. The constants are assumed to be about the same as those for O'Gyalla, namely: T_0 , 2.5 seconds; V , 40; J , 62 meters; M , 105 kg.; L , 1.55 meters.

	FIRST PRELIMINARY TREMORS.		SECOND PRELIMINARY TREMORS.		PRINCIPAL PART.		MAX.	AMPLITUDE.	PERIOD.	EARTH'S AMPLITUDE.
	<i>m.</i>	<i>s.</i>	<i>m.</i>	<i>s.</i>	<i>m.</i>	<i>s.</i>	<i>m. s.</i>	<i>mm.</i>	<i>sec.</i>	<i>mm.</i>
(1) North component . . .	25	33	35	21	53	16	01 09	2.2	21	3.9
(2) East component . . .	25	17	35	42	53	16	01 04	1.6	21	2.8
Average	25	25	35	31	53	16				
Interval	12	57	23	03	40	48				

The earth-amplitudes are quite uncertain on account of the uncertainties of the constants of the instrument.

The times, periods, and amplitudes are taken from the "Bulletin hebdomadaire des observatoires sismiques de la Hongrie et de la Croatie."

POLA, AUSTRIA.

K. K. Hydrographisches-Amt. Prof. Dr. August Gratzl, director.

Lat. $44^{\circ} 52' N.$; long. $13^{\circ} 51' E.$; distance, 88.34° or 9,821 km.; chord, 8,877 km.; direction, N. $29^{\circ} E.$

The instrument used was a Vicentini microseismograph, three components; mechanical registration on smoked paper. The seismogram was too faint for reproduction.

(1) North and (2) east components: T_0 , 2.24 seconds; V , 110; J , 138 meters; ϵ , 1.03; r , 0.1 mm.; M , 100 kg.; L , 125 cm.

(3) Vertical component: T_0 , 0.92 second; V , 135; J , 29 meters; M , 50 kg.

	FIRST PRELIMINARY TREMORS.		SECOND PRELIMINARY TREMORS.		REGULAR WAVES.		PRINCIPAL PART.		MAX.		AMPLITUDE.		PERIOD.		EARTH'S AMPLITUDE.	
	<i>m.</i>	<i>s.</i>	<i>m.</i>	<i>s.</i>	<i>m.</i>	<i>s.</i>	<i>m.</i>	<i>s.</i>	<i>m.</i>	<i>s.</i>	<i>mm.</i>	<i>sec.</i>	<i>mm.</i>			
(1) North component	25	56	36	13	46	05	54	29	09	29	1.6	14	0.5			
(2) East component	53	59	02	11	2.5	21	1.9			
Average . . .	25	56	36	13	46	05	54	14								
Interval . . .	13	28	23	45	33	37	41	46								

Nothing is visible in the vertical component. The greatest earth-amplitude on the north component was 1 mm. at $14^h 04.0^m$.

QUARTO-CASTELLO (FLORENCE), ITALY.

Osservatorio Geodinamico di Quarto-Castello. Dr. Raffaello Stiattesi, director.

Lat. $43^{\circ} 49' N.$; long. $11^{\circ} 16' E.$; altitude, 90 meters; distance, 88.40° or 9,828 km.; chord, 8,882 km.; direction, N. $31^{\circ} E.$

Foundation, directly on Upper Eocene limestone.

Seismograms, sheet No. 6.

The instruments used were Stiattesi horizontal pendulums, two components; mechanical registration on smoked paper.

(1) North component: T_0 , 21.4 seconds; V , 50; J , 3,780 meters; M , 500 kg.; L , 1.80 meters.

(2) East component: T_0 , 17.4 seconds; V , 50; J , 5,700 meters; M , 500 kg.; L , 1.80 meters.

	FIRST PRELIMINARY TREMORS.		SECOND PRELIMINARY TREMORS.		REGULAR WAVES.		PRINCIPAL PART.		MAX.		AMPLITUDE.		PERIOD.		EARTH'S AMPLITUDE.	
	<i>m.</i>	<i>s.</i>	<i>m.</i>	<i>s.</i>	<i>m.</i>	<i>s.</i>	<i>m.</i>	<i>s.</i>	<i>min.</i>	<i>mm.</i>	<i>sec.</i>	<i>mm.</i>				
(1) North component	26	35	37	10	52	39 ?	58	36	04	255 +	30	10.2 +				
(2) East component	26	42	36	58	51	24		07	265 +	17	1.2 +				
Average	26	38	37	04	52	01 ?										
Interval	14	10	24	36	39	33 ?										

The periods are shown on the seismogram. It is not clear why so large a movement of the earth is indicated on the north component. The foundation is limestone, and other stations, not far distant, record much smaller displacements; and the east component indicates an earth-amplitude only about 0.1 as much. This large amplitude can not be accepted as true.

ZI-KA-WEI, CHINA.

Meteorological, Magnetic, and Seismological Observatory. Rev. Louis Froc, S. J., director.

Lat. $31^{\circ} 12' N.$; long. $121^{\circ} 26' E.$; altitude, 7 meters; distance, 88.49° or 9,838 km.; chord, 8,889 km.; direction, N. $50^{\circ} W.$

Foundation, alluvium.

Seismograms, sheet No. 15.

The instrument used was an Omori horizontal pendulum, east component; mechanical registration on smoked paper. T_0 , 33.2 seconds; V , 15; J , 4,100 meters; ϵ , 1.07; r , 1.5 mm.; M , 15 kg.; L , 75.6 cm.

	FIRST PRELIMINARY TREMORS.		(b) SECOND PRELIMINARY TREMORS.		(d) REGULAR WAVES.		MAX.	AMPLITUDE.	PERIOD.
	<i>m.</i>	<i>s.</i>	<i>m.</i>	<i>s.</i>	<i>m.</i>	<i>s.</i>			
East component . . .	25	24	35	36	56	00?	<i>min.</i> 09	<i>mm.</i> 27	<i>sec.</i> 29.6
Interval . . .	12	56	23	08	43	32?			

The beginning of the movement is not shown on the seismogram, and the beginning of the long waves is not very clear. At 58^m the period of the waves is 26.4 seconds and the recorded amplitude 20 mm.; the actual magnifying power is 40.5, making the earth-amplitude 0.5 mm. At 09^m the period is 29.6 seconds, the recorded amplitude 27 mm., and the magnifying power 60; and therefore the earth's amplitude is only 0.45 mm.

PILAR, ARGENTINA.

Observatorio Magnetico. W. G. Davis, director.

Lat. $31^{\circ} 40' S.$; long. $63^{\circ} 50.5' W.$; altitude, 340 meters; distance, 88.75° or 9,866 km.; chord, 8,909 km.; direction, S. $47^{\circ} E.$

Foundation, compact alluvium.

Seismograms, sheet No. 1.

The instrument used was a Milne horizontal pendulum, east component. T_0 , 15 seconds; V , 6.1; J , 340 meters; ϵ , 1.076; M , 255 gm.; L , 15.6 cm.

First preliminary tremors, 25.6^m ; interval, 13.1 minutes. Maximum, 36.8^m ; interval, 24.3 minutes. Amplitude, 0.2 mm.

Duration, 1.3 hours. It is impossible to determine the beginning of the motion from the reproduction of the seismogram; it is only possible to see a small swelling at the time of the maximum, which apparently occurs during the second preliminary tremors. It is not clear why the record should have been so small.

URBINO, ITALY.

Osservatorio Meteorico-Sismico. Prof. T. Allipi, director.

Lat. $43^{\circ} 43' N.$; long. $12^{\circ} 38' E.$; distance, 88.82° or 9,875 km.; chord, 8,916 km.; direction, N. $30^{\circ} E.$

The instrument used was an Agamennone vertical pendulum (modified), two horizontal components; mechanical registration with ink on white paper. T_0 , 5 seconds; V , 24; J , 150 meters; M , 112 kg.; L , 6.2 meters.

(1) North component: $13^h 54^m 50^s$ to $14^h 16^m 00^s$.

(2) East component: $13^h 56^m 40^s$ to $14^h 11^m 00^s$.

Observations much too late; they probably represent only the principal part. The earlier phases were not recorded.

ROCCA DI PAPA, ITALY.

R. Osservatorio Geodinamico. Prof. G. Agamennone, director.

Lat. $41^{\circ} 46' N.$; long. $12^{\circ} 42' E.$; altitude, 760 meters; distance, 90.48° or 10,061 km.; chord, 9,046 km.; direction, N. $32^{\circ} E.$

Foundation, volcanic rock.

Seismograms, sheet No. 14.

The instruments used were:

Microseismograph Agamennone, two components; mechanical registration with ink on white paper.

(1) Northwest component: T_0 , 4.2 seconds; V , 60; J , 264 meters; ϵ , 1.0; r , 0.38 mm.; M , 500 kg.; L , 4.39 meters.

(2) Northeast component: T_0 , 4.2 seconds; V , 60; J , 264 meters; ϵ , 1.0; r , 0.20 mm.; M , 500 kg.; L , 4.39 meters.

New microseismometrograph Agamennone (80 kg.), two components; mechanical registration on smoked paper.

(3) North and (4) east components: T_0 , 2.6 seconds; V , 100; J , 168 meters; ϵ , 1.0; r , 0.1 mm.; M , 80 kg.; L , 1.68 meters.

Cancani horizontal pendulums, two components; mechanical registration with ink on white paper.

(5) North component: T_0 , 27.2 seconds; V , 1; J , 185 meters; ϵ , 1.03; r , 0.0 mm.; M , 60 kg.; L , 1.00 meter (?).

(6) East component: T_0 , 26.6 seconds; V , 1; J , 176 meters; ϵ , 1.06; r , 0.0 mm.; M , 60 kg.; L' , 1.76 meters; L , 1.00 meter (?).

	SECOND PRELIMINARY TREMORS.		REGULAR WAVES.		PRINCIPAL PART.		MAX.	AMPLITUDE.	PERIOD.	EARTH'S AMPLITUDE.
	m.	s.	m.	s.	m.	s.				
(1) Northwest component	36	15	56	25?	min. 07.3	mm. 3.2	sec. 19	mm. 1.15
(2) Northeast component	36	57	57	25?	57	29	m. s. 10 11	2.0	17	0.5
(3) North component	57	50?	06	00	07 00	2.0	17	0.8
(4) East component . .	35	46	58	14?	03	20?	07 30	2.0	17	0.8
(5) North component . .	36	34	57	50	59	15	05 20	12.5	26	
(6) East component . .	37	00	57	15	01	25	04 14	15.0	27	
Average	36	30	57	30						
Interval	24	02	45	02						

Duration, 2 hours. The beginning of the motion on all the instruments was masked by vibrations due to high winds.

The seismograms are reproduced from tracings, which, in the case of the 80 kg. Agamennone seismograph, do not bring out the regularity and fineness of the original record on smoked paper. One sees, however, the short vibrations of the pendulum superposed on the larger earth vibrations. The greatest earth-amplitude was at $14^h 07.3^m$; the 500 kg. seismograph indicates an amplitude of 1.1 mm. in the northwest direction, and the two components of the 80 kg. instrument indicate: North, 0.82 mm.; east, 1.14 mm.; a total amplitude of about 1.4 mm. in the northwest or northeast direction. These instruments therefore partially confirm each other and indicate that the maximum motion was in the line of propagation.

The Cancani horizontal pendulums have no damping; and since their natural periods correspond closely to those of the disturbance, no conclusion can be drawn from their record regarding the earth's amplitude.

BELGRADE, SERVIA.

Royal Astronomical and Meteorological Observatory. Prof. Dr. M. Nedelkovitch, director.

Lat. $44^{\circ} 48' N.$; long. $20^{\circ} 09' E.$; distance, 90.67° or 10,080 km.; chord, 9,061 km.; direction, N. $25^{\circ} E.$

Foundation, argillaceous alluvium, 130 meters thick, on Cretaceous limestones.

The instrument used was a Vicentini-Konkoly microseismograph, two components; mechanical registration on smoked paper.

(1) North component: T_0 , 2.4 seconds; V , 33; J , 47 meters; M , 105 kg.; L , 1.43 meters.

(2) East component: T_0 , 2.4 seconds; V , 48; J , 63 meters; M , 105 kg.; L , 1.43 meters.

Average: Second preliminary tremors, $36^m 54^s$; interval, $24^m 26^s$. Maximum, $02^m 51^s$. Amplitude, 1.0 mm.

Duration, 1.9 hours.

CARLOFORTE, SARDINIA, ITALY.

Stazione Astronomica Internazionale. Dr. L. Volta, director.

Lat. $39^{\circ} 08' N.$; long. $80^{\circ} 19' E.$; altitude, 18 meters; distance, 90.71° or 10,085 km.; chord, 9,067 km.; direction, N. $36^{\circ} E.$

Foundation, trachitic rock.

The instrument used was a Vicentini microseismograph, two horizontal components; mechanical registration on smoked paper.

Northwest and northeast components: T_0 , 2.2 seconds; V , 50; J , 60 meters; ϵ , 1.0. r , 0.1 (northwest component), 0.05 (northeast component); M , 100 kg.; L , 1.20 meters;

The original seismogram (too faint for reproduction) does not give clearly the times of the phases, but it shows, at $14^h 07^m$, waves of period 17 seconds and amplitude 0.5 mm.; as the magnifying power for these waves is 0.85, the earth's amplitude at that time was 0.6 mm., and since this amplitude was common to both components, the total possible amplitude of the earth's movement was 0.85 mm. At $14^h 02^m$ the northeast component shows waves of period 20.4 seconds and amplitude 0.2 mm., indicating an amplitude of the earth in that direction of 0.34 mm. On the northwest component the amplitude is 0.2 mm., and period 27 seconds, therefore the earth's amplitude is 0.6 mm.; the movement at this time has a stronger component in the northwest direction, that is, in the direction of propagation.

SARAJEVO, BOSNIA.

Meteorologisches Bureau. Herr Ph. Ballif, director; Herr Passinij, section chief.

Lat. $43^{\circ} 52' N.$; long. $18^{\circ} 26' E.$; altitude, 633 meters; distance, 90.89° or 10,104 km.; chord, 9,078 km.; direction, N. $27^{\circ} E.$

Foundation, clay; on northern slope of a hill.

Seismograms, sheet No. 15.

The instrument used was a Vicentini microseismograph, two horizontal components; mechanical registration on smoked paper.

(1) North component: T_0 , 2.2 seconds; V , 156; J , 188 meters; M , 100 kg.; L , 1.20 meters.

(2) East component: T_0 , 2.2 seconds; V , 138; J , 166 meters; M , 100 kg.; L , 1.20 meters.

	SECOND PRELIMINARY TREMORS.		PRINCIPAL PART.		MAX.		AMPLITUDE.	PERIOD.	EARTH'S AMPLITUDE.
	<i>m.</i>	<i>s.</i>	<i>m.</i>	<i>s.</i>	<i>m.</i>	<i>s.</i>	<i>mm.</i>	<i>sec.</i>	<i>mm.</i>
(1) North component .	40	05	57	47?	03	40	0.4	30	0.47
(2) East component .	33	10	54	16?	03	40	0.75	25	0.7
					14	39.5	1.0	20	0.6

Duration, 1 hour. The first preliminary tremors are not recorded, but a bell connected with a seismoscope rang at 13^h 25^m. The east component began to record earlier than the north, and throught gave much larger amplitudes. The maximum movement of the ground was at 14^h 03.7^m and amounted to about 0.54 mm.; at 14^h 10.5^m it was 0.46 mm.; its direction was nearly east-west.

ISCHIA, ITALY.

R. Osservatorio Geodinamico di Casamicciola. Two installations, one at Porto d'Ischia and one at Grande Sentinella, about 3 km. apart. Prof. G. Grablowitz, director.

PORTO D'ISCHIA.

Lat. 40° 44' N.; long. 13° 57' E.; altitude, 31 meters; distance, 91.84° or 10,211 km.; chord, 9,153 km.; direction, N. 31° E.

Foundation, trachite.

Seismograms, sheet No. 7.

The instruments used were:

Grablowitz horizontal pendulums, two components:

(1) North component: T_0 , 17 seconds; V , 8; J , 570 meters; ϵ , 1.24; r , 0.8 mm.; M , 12 kg.; L , 8 cm.

(2) East component: T_0 , 17 seconds; V , 8; J , 570 meters; ϵ , 1.07; r , 0.2 mm.; M , 12 kg.; L , 8 cm.

Vasca Sismica, two horizontal components. This is a circular tank containing water; two floats are placed near the sides at ends of a north-south and of an east-west diameter respectively, and the movement of the water is magnified and recorded on a drum. The tank is 1.56 meters in diameter and the water is one meter deep. The movement of the north-south diameter is magnified 74.4 times, that of the east-west diameter 68.6 times.

GRANDE SENTINELLA.

Lat. 40° 45' N.; long. 13° 54' E.; altitude, 122 meters; distance, 91.83° or 10,210 km.; chord, 9,151 km.; direction, N. 31° E.

Foundation, volcanic tuff.

Seismograms, sheet No. 7.

The instruments used were:

(5) Grablowitz horizontal pendulum, east component: T_0 , 12 seconds; V , 8; J , 290 meters; ϵ , 1.18; r , 0.5 mm.; M , 12 kg.; L , 10 cm.

(6) and (7) Vasca Sismica, two components; it has the same dimensions as the tank at Porto d'Ischia. V , 90.7 for the north component and 97.3 for the east component.

All the instruments at both stations record on smoked paper.

	FIRST PRELIMINARY TREMORS.		SECOND PRELIMINARY TREMORS.		REGULAR WAVES.		PRINCIPAL PART.		MAX.		AMPLI- TUDE.		PERIOD.	
	<i>m.</i>	<i>s.</i>	<i>m.</i>	<i>s.</i>	<i>m.</i>	<i>s.</i>	<i>m.</i>	<i>s.</i>	<i>m.</i>	<i>s.</i>	<i>mm.</i>	<i>sec.</i>	<i>m.</i>	<i>sec.</i>
(1) North component	36	49?	07	00	08	34	25	17		
(2) East component	04	31	08	27	50	17		
(5) East component . . .	26	42?	37	07	56	24	04	00	10	25	7.5	12.6		
Average	26	42?	36	58	56	24								
Interval	14	14?	24	30	43	56								

The vibrations of the water make it impossible to determine the phases from the Vasca Sismica either at Porto d'Ischia or at Grande Sentinella; at the former distinct waves of period about 18 seconds and amplitude 0.6 mm. occur from 14^h 04.0^m to 14^h 18.0^m. At Grande Sentinella, the waves are discernible at 13^h 56.0^m; a maximum with amplitude of nearly 1 mm. is reached at 14^h 07.0^m; the periods are from 18 to 24 seconds.

During the strong motion the periods of the vibrations recorded by the Grablowitz pendulums are the same as those of the pendulums themselves; namely, 17 seconds at Porto d'Ischia and 12 seconds at Grande Sentinella. If we attempt to find the earth-amplitudes by using the values of the damping and friction, we find 0.33 mm. or less; but it is evident that the regular movement did not continue long enough to allow the pendulums to take their full amplitudes.

CAGGIANO (SALERNO), ITALY.

Osservatorio Meteorologico-Geodinamico. Signor P. Allard, director.

Lat. 40° 54' N.; long. 15° 30' E.; altitude, 831 meters; distance, 92.63° or 10,297 km.; chord, 9,213 km.; direction, N. 30° E.

The instrument used was an Agamennone seismometrograph, northwest and southwest components; mechanical registration with ink on white paper. T_0 , 6 seconds; V , 12.5; J , 112 meters; M , 200 kg.; L , 8.95 cm.

	SECOND PRELIMINARY TREMORS.		REGULAR WAVES.		MAX.		AMPLITUDE.		PERIOD.		EARTH'S AMPLITUDE.	
	<i>m.</i>	<i>s.</i>	<i>m.</i>	<i>s.</i>	<i>m.</i>	<i>s.</i>	<i>mm.</i>	<i>sec.</i>	<i>sec.</i>	<i>mm.</i>	<i>mm.</i>	
Northwest component . . .	36	40	56	46	04	10	0.9	22		0.95		
Interval	24	12	44	18								

At 13^h 59.5^m the long waves on the northwest component had an amplitude of 0.4 mm. and a period of 32 seconds, corresponding to an earth-amplitude of 1 mm. At 14^h 07.3^m the northwest earth-amplitude was 0.68 mm. The northeast component was not perfectly free and was less sensitive than the northwest, so that the times can not be made out reliably; but notwithstanding this it indicated an earth-amplitude of 2.2 mm. at 14^h 04.2^m; denoting the strongest motion at right angles to direction of propagation.

The seismogram arrived too late for reproduction.

TAIHOKU, FORMOSA, JAPAN.

Meteorological Observatory. H. Kondo, director.

Lat. 25° 04' N.; long. 121° 31' E.; altitude, 10 meters; distance, 92.75° or 10,311 km.; chord, 9,222 km.; direction, N. 55° W.

Foundation, clay.

Seismograms, sheet No. 15.

The instrument used was an Omori horizontal pendulum, east component; mechanical registration on smoked paper. T_0 , 17 seconds; V , 10; J , 720 meters; ϵ , 1.27; r , 0.13

mm.; M , 6 kg.; L , $76 \pm$ cm. The times on the seismogram are a , $13^{\text{h}} 38^{\text{m}} 52^{\text{s}}$; b , $13^{\text{h}} 56^{\text{m}} 20^{\text{s}}$; c , $14^{\text{h}} 20^{\text{m}} 27^{\text{s}}$; d , $15^{\text{h}} 00^{\text{m}} 48^{\text{s}}$.

	(a) PRELIMINARY TREMORS.		(b) REGULAR WAVES.		MAX.	AMPLITUDE.	PERIOD.	EARTH'S AMPLITUDE.
	<i>m.</i>	<i>s.</i>	<i>m.</i>	<i>s.</i>	<i>min.</i>	<i>mm.</i>	<i>sec.</i>	<i>mm.</i>
East component	28	52	56	20	0.0	3.5	22	0.25
Interval	16	24	43	52				

The time of the beginning is evidently too late. It is probable that the earth-amplitude was greater than calculated, as the large vibration lasted for a very short time.

SOFIA, BULGARIA.

Central Meteorological Institute. Dr. Spas Watzof, director.

Lat. $42^{\circ} 42'$ N.; long. $23^{\circ} 20'$ E.; altitude, 550 meters; distance, 93.58° or 10,404 km.; chord, 9,286 km.; direction, N. 24° E.

Foundation, sands and sandy shales.

Seismograms, sheet No. 13.

The instruments used were Bosch-Omori horizontal pendulums, two horizontal components; mechanical registration on smoked paper.

(1) North component: T_0 , 20.8 seconds; V , 10.1; J , 108 meters; ϵ , 1.0; r , 2.7 mm.; M , 10 kg.; L , 74 cm.

(2) East component: T_0 , 31.0 seconds; V , 10.1; J , 2,400 meters; ϵ , 1.0; r , 4.0 mm.; M , 10 kg.; L , 74 cm.

	(a) FIRST PRELIMINARY TREMORS.	(b) SECOND PRELIMINARY TREMORS.	REGULAR WAVES.	PRINCIPAL PART.	MAX.	AMPLITUDE.	PERIOD.
	<i>min.</i>	<i>min.</i>	<i>min.</i>	<i>min.</i>	<i>min.</i>	<i>mm.</i>	<i>sec.</i>
(1) North component	25.00	35.5	57.5	03.0	04.7 to 05.8	50 +	21.9
(2) East component	36.0	56.7	60 +	28.9
Average	25.00	35.45	57.06				
Interval	12.32	23.17	44.38				

During the long waves at $14^{\text{h}} 01.5^{\text{m}}$, the north earth-amplitude was 0.48 mm. During the maximum movement of the pendulums the periods of vibration correspond very nearly to the proper periods of the pendulums; we can not therefore determine the earth's movement. It is very difficult to determine the times of the first and second preliminary tremors accurately; nor is it clear where we should place the beginning of the regular waves.

MESSINA, SICILY, ITALY.

Istituto di Fisica terrestre e Meteorologia della R. Università. Prof. B. G. Rizzo, director.

Lat. $38^{\circ} 12'$ N.; long. $15^{\circ} 33'$ E.; altitude, 46 meters; distance, 94.67° or 10,524 km.; chord, 9,368 km.; direction, N. 32° E.

Seismograms, sheet No. 12.

The instrument used was a Vicentini microseismograph, three components; mechanical registration on smoked paper.

(1) Northeast component: T_0 , 2.4 seconds; V , 100; J , 143 meters; M , 106 kg.; L , 1.43 meters.

(2) Northwest component: T_0 , 2.4 seconds; V , 100; J , 143 meters; ϵ , 1.04; M , 106 kg.; L , 1.43 meters.

(3) Vertical component: T_0 , 1.8 seconds; V , 120; J , 97 meters; ϵ , 1.14; M , 56 kg.

The records were greatly disturbed by the wind so that the times of arrival of the first two phases were entirely lost; the long waves appear at 13^h 55.5^m on the northwest component. The greatest movement of the earth occurred during the principal part, at M_2 (14^h 07.8^m), when we find

	AMPLITUDE.	PERIOD.	EARTH'S AMPLITUDE.
	<i>mm.</i>	<i>sec.</i>	<i>mm.</i>
Northwest component . .	2.0	22	1.66
Northeast component . .	0.4	21	0.30
Vertical component . . .	0.2	22	0.25

As a possible maximum of the earth-amplitude we have 1.7 mm. During the long waves, at 14^h 04.7^m, the period was 30 seconds, and the earth-amplitude 0.93 mm. The letters on the seismogram correspond to times as follows: M_1 , 14^h 04.3^m; M_2 , 14^h 07.8^m; M_3 , 14^h 10.1^m; M_4 , 14^h 12.7^m.

CATANIA, SICILY, ITALY.

R. Osservatorio di Catania ed Etneo. Prof. A. Riccò, director.

Lat. 37° 30' N.; long. 15° 05' E.; altitude, 42 meters; distance, 95.04° or 10,567 km.; chord, 9,396 km.; direction, N. 32° E.

Foundation, lava.

Seismograms, sheet No. 13.

The instrument used was a long vertical pendulum, two horizontal components; mechanical registration with ink on white paper.

(1) Northeast component: T_0 , 10 seconds; V , 12.5; J , 310 meters; ϵ , 1.01; r , 0.4 mm.; M , 300 kg.; L , 24.9 meters.

(2) Northwest component: T_0 , 10 seconds; V , 12.5; J , 310 meters; ϵ , 1.026; r , 0.5 mm.; M , 300 kg.; L , 24.9 meters.

	FIRST PRELIMINARY TREMORS.		SECOND PRELIMINARY TREMORS.		REGULAR WAVES.		PRINCIPAL PART.		MAX.		AMPLITUDE.	PERIOD.	EARTH'S AMPLITUDE.
	<i>m.</i>	<i>s.</i>	<i>m.</i>	<i>s.</i>	<i>m.</i>	<i>s.</i>	<i>m.</i>	<i>s.</i>	<i>m.</i>	<i>s.</i>	<i>mm.</i>	<i>sec.</i>	<i>mm.</i>
(1) Northeast component	26	05	37	27	56	24	04	45	12	51	4.0	18	0.72
(2) Northwest component	26	05	35	23	06	50	07	08	4.0	18	0.72
Average	26	05	36	25?	56	24	05	48?					
Interval	13	37	23	57?	43	56	53	20?					

At the times of the maximum on each component the movement is comparatively small on the other component, so that the total earth-amplitude would not be more than about 0.8 mm. The northwest component shows signs of friction; this may be the reason why it does not bring out the long waves, and why the principal part is of somewhat shorter duration than on the northeast component.

RIO DE JANEIRO, BRAZIL.

Observatorio de Rio de Janeiro. Dr. H. Morize, director.

Lat. 22° 54' S.; long. 43° 10' W.; altitude, 44 meters; distance, 96.28° or 10,703 km.; chord, 9,488 km.; direction, S. 66° E.

Foundation, decomposed gneiss.

The instruments used were Bosch-Omori horizontal pendulums, two horizontal components; mechanical registration on smoked paper. M , 15 kg.; V , 15.

The solid friction was so strong that it rendered the pendulums almost aperiodic and masked the details of the motion; for this reason the seismogram is not reproduced. The first movement discernible on the east component is at 13^h 39.7^m; and on the north component at 13^h 54^m. The total duration is nearly an hour.

WELLINGTON, NEW ZEALAND.

Department of Education. G. Hogben, director.

Lat. 41° 17' S.; long. 174° 47' E.; altitude, 15 meters; distance, 97.62° or 10,853 km.; chord, 9,588 km.; direction, S. 42° W.

Foundation, directly on the "Wellington Slates" near the edge of a cliff, 15 meters high, near Wellington Harbor.

Seismograms, sheet No. 2.

The instrument used was a Milne horizontal pendulum, east component; photographic registration. T_0 , 18.6 seconds; V , 6.1; J , 525 meters; ϵ , 0.14; M , 255 gm.; L , 15.6 cm.

	FIRST PRELIMINARY TREMORS.	SECOND PRELIMINARY TREMORS.	PRINCIPAL PART.
	<i>min.</i>	<i>min.</i>	<i>min.</i>
East component . . .	26.6	36.8	02.2 (?)
Interval	14.1	24.3	49.7 (?)

CALAMATE, GREECE.

National Astronomical Observatory. Prof. Dr. D. Eginitis, director.

Lat. 37° 02' N.; long. 22° 15' E.; altitude, 32 meters; distance, 98.28° or 10,927 km.; chord, 9,636 km.; direction, N. 28° E.

Seismograms, sheet No. 15.

The instrument used was an Agamennone vertical pendulum, two horizontal components; mechanical registration with ink on white paper. T_0 , 6.95 ± seconds; V , 12; J , 144 meters; M , 200 kg.; L , 1.44 m.

The disturbance began at 14^h 02^m 06^s and lasted 18 minutes. Evidently the preliminary tremors were not recorded, but only the principal part, whose interval is 49^m 38^s.

TIFLIS, CAUCASIA, RUSSIA.

Physical Observatory. Herr S. von Hlasek, director.

Lat. 41° 43' N.; long. 44° 48' E.; distance, 99.43° or 11,054 km.; chord, 9,719 km.; direction, N. 9° E.

The instruments used were:

Ehlert triple horizontal pendulum, photographic registration.

Milne horizontal pendulum, photographic registration, east component.

Bosch-Omori horizontal pendulums, two components; mechanical registration on smoked paper.

Two heavy Zöllner horizontal pendulums.¹

First preliminary tremors, 26^m 09^s; interval, 13^m 41^s. Second preliminary tremors, 37^m 59^s; interval, 25^m 31^s.

TASCHKENT, RUSSIAN TURKESTAN.

Astronomical and Physical Observatory. M. Ossipoff, director.

Lat. 41° 20' N.; long. 69° 18' E.; altitude, 478 meters; distance, 99.86° or 11,102 km.; chord, 9,750 km.; direction, N. 9° W.

Foundation, stiff loess.

¹ The times are taken from "Die Erdbebenwellen" by Drs. Wiechert and Zoeppritz. Nach. d. Gesell. d. Wissen. Göttingen, Math. Phys. Kl. 1907. No further information is given.

The instruments used were:

Repsold-Zöllner horizontal pendulums, two components; photographic registration. Seismograms, sheet no. 2.

(1) North component: T_0 , 9.2 seconds; V , 59; J , 1,240 meters; M , 59.1 gm.; L , 13 cm.

(2) East component: T_0 , 7.94 seconds; V , 60; J , 940 meters; M , 59.1 gm.; L , 12.7 cm.

Bosch-Omori horizontal pendulums, two components; mechanical registration on smoked paper. Seismograms, sheet No. 13.

(3) North and (4) east components: T_0 , 12 seconds; V , 10 (?); J , 360 (?) meters; M , 11 kg.; L , 75 cm.

	FIRST PRE- LIMINARY TREMORS.	SECOND PRELIMINARY TREMORS.	REGULAR WAVES.	PRINCIPAL PART.	MAX.	AMPLI- TUDE.	PERIOD.	EARTH'S AMPLI- TUDE.
	<i>min.</i>	<i>min.</i>	<i>min.</i>	<i>m. s.</i>	<i>m. s.</i>	<i>mm.</i>	<i>sec.</i>	<i>mm.</i>
(1) North component	26.5	(31.0)	(43.0)	80 +
(2) East component	(30.7)	37.8	48.4	80 +
(3) North component	<i>m. s.</i> 36 56	<i>m. s.</i> 53 20	<i>m. s.</i> (09 56)	<i>m. s.</i> 10 56	10	24	3.0
(4) East component	(51.26)	(59 06)	(06 08)	(14 27)	(21 21)	33	32
Average	26.5	37 22						
Interval	14.0	24 54						

The times in parentheses are not used, as they are evidently erroneous; the cause is unknown; the times of (4), for instance, are all much too late, but I can not discover the cause. (4) also indicates an earth-amplitude of 20 mm., which is impossible:

CHRISTCHURCH, NEW ZEALAND.¹

Magnetic Observatory. Henry F. Skey, B. Sc., director.

Lat. 43° 32' S.; long. 172° 37' E.; distance, 100.40° or 11,162 km.; chord, 9,788 km.; direction, S. 42° W.

The instrument used was a Milne horizontal pendulum, east component; photographic registration. V , 6.1; M , 255 gm.; L , 15.6 cm.

East component: Second preliminary tremors, 33.6^m; interval, 21.1 minutes. Regular waves, 01.0^m, interval, 48.5 minutes. Maximum, 30.0^m. Amplitude, 6.8 mm. Duration, 3.3 hours.

MANILA, PHILIPPINE ISLANDS.

Manila Central Observatory. Rev. José Algué, S. J., director.

Lat. 14° 35' N.; long. 120° 59' E.; altitude, 10 meters; distance, 100.46° or 11,169 km.; chord, 9,793 km.; direction, S. 118° W.

Foundation, sand 14 meters thick over volcanic tuff.

Seismograms, sheet No. 4.

The instrument used was a Vicentini microseismograph, two horizontal and vertical components; mechanical registration on smoked paper. East-northeast component: T_0 , 2.4 seconds; V , 100; J , 1,430 meters; M , 100 kg.; L , 1.43 meters.

	FIRST PRE- LIMINARY TREMORS.	REGULAR WAVES.	MAX.	AMPLI- TUDE.	PERIOD.
	<i>m. s.</i>	<i>min.</i>	<i>min.</i>	<i>mm.</i>	<i>sec.</i>
East-northeast component	22 44	01.0	08.0	0.9	18
Interval	10 16	48.5			

¹ The times are taken from Circular 15, issued by the Seismological Committee of the British Association for the Advancement of Science.

Duration, 3 hours. The time of the beginning is evidently too early; the smallness of the motion makes it quite impossible to determine the precise time. The north-northwest component (not reproduced) gives a record very similar to the other, but with a somewhat smaller amplitude. The maximum instrumental amplitude is at 14^h 08.0^m, when the earth-amplitude was (ENE.) 0.44 mm., (NNW.) 0.4 mm., or a possible total of 0.6 mm. Data are not at hand to determine the vertical earth movement, tho the instrumental amplitude was 0.25 mm. A larger earth-amplitude occurred during the long waves; we find, at 14^h 01.0^m, earth-amplitudes (ENE.) 0.75 mm., (NNW.) 0.45 mm., or a possible total of 0.87 mm. If instead of a short-period pendulum there had been one with a period in the neighborhood of 25 seconds, the record would have been very large at this time; and if the period had been about 20 seconds, the record would have been very large at 14^h 08.0^m; as it is, with a period of 2.4 seconds, the record is quite small. The strong contrast between the seismograms of Manila and that of Potsdam, on the same plate, is principally due to the periods of the pendulums at the respective places. At Potsdam the period was 18 seconds.

TADOTSU, JAPAN.

Meteorological Observatory. N. Maeda, director.

Lat. 34° 17' N.; long. 133° 46' E.; altitude, 6 meters; distance, 101.30° or 11,262 km.; chord, 9,852 km.; direction, N. 55° W.

The instrument used was an Omori horizontal pendulum; mechanical registration on smoked paper. M , 10 kg.; V , 20; L , 75 cm.¹

First preliminary tremors, 25^m 07^s; interval, 12 minutes 39 seconds.

CAIRO, EGYPT.

Helwan Observatory. H. H. Wade, director.

Lat. 29° 52' N.; long. 31° 20.5' E.; altitude, 115 meters; distance, 107.92° or 11,998 km.; chord, 10,302 km.; direction, N. 23° E.

Foundation, directly on Eocene limestones; in the desert about 5 km. from the Nile. Seismograms, sheet No. 1.

The instrument used was a Milne horizontal pendulum, east component; photographic registration. T_0 , 15 seconds; V , 6.1; J , 340 meters; ϵ , 1.054; angular displacement, 1 mm. = 0.5"; M , 255 gm.; L , 15.6 cm.

	FIRST PRE-LIMINARY TREMORS.	SECOND PRE-LIMINARY TREMORS.	MAX.	AMPLITUDE.
East component . . .	<i>min.</i> 31.0?	<i>min.</i> 39.0?	14 ^h 34.0 ^m	<i>mm.</i> 4.0
Interval . . .	18.5?	26.5?		

Duration, 3.5 hours. Only a drawing of the seismogram was available; this and the indefinite character of the seismogram make it impossible to obtain accurate time determinations of the various phases. The beginning of the first preliminary tremors are evidently too late, but the time of the second preliminary tremors seems about right.

¹ The constants are taken from Professor Omori's Report on the Great Indian Earthquake. "Pub. Earthquake Investigation Commission in Foreign Language, No. 24." The time is taken from Bulletin of the same Commission, vol. 1, No. 1.

CALCUTTA, INDIA.

Alipore Meteorological Observatory. G. W. K uchler, assistant meteorological reporter.
 Lat. $22^{\circ} 32'$ N.; long. $88^{\circ} 20'$ E.; altitude, 6.5 meters; distance, 112.72° or 12,531
 km.; chord, 10,607 km.; direction, N. 31° W.

Foundation, marshy alluvium; 100 km. from the sea, and far from mountains.
 Seismograms, sheet No. 1.

The instrument used was a Milne horizontal pendulum, east component; photographic registration. T_0 , 18 seconds; V , 6.1; J , 490 meters; ϵ , 1.10; angular displacement, 1 mm. = $0.38''$; M , 255 gm.; L , 15.6 cm.

	FIRST PRE- LIMINARY TREMORS.	SECOND PRE- LIMINARY TREMORS.	REGU- LAR WAVES.	MAX.	AMPLI- TUDE.
	<i>min.</i>	<i>min.</i>	<i>min.</i>	<i>min.</i>	<i>mm.</i>
East component . . .	29.2?	39.4	05.6?	17.3	17
Interval . . .	16.7?	26.9	53.1?		

Duration, 4.1 hours. It is difficult to determine the exact time of beginning, as there was a slight disturbance of the beam. The time of the second preliminary tremors is less doubtful.

BOMBAY, INDIA.

Government Observatory. N. A. F. Moos, director.

Lat. $18^{\circ} 54'$ N.; long. $72^{\circ} 49'$ E.; altitude, 11 meters; distance, 121.19° or 13,472
 km.; chord, 11,099 km.; direction, N. 17° W.

Foundation, basaltic trap.

The instruments used were:

(1) Milne horizontal pendulum, east component; photographic registration. Seis-
 mograms, sheet No. 2. T_0 , 18 seconds; V , 6.1; J , 490 meters; angular displacement,
 1 mm. = $0.47''$; M , 255 gm.; L , 15.6 cm.

Colaba horizontal pendulums, two components; mechanical registration with ink on
 paper. Seismograms, sheet No. 15.

(2) North component: T_0 , 24 seconds; V , 3; J , 430 meters; angular displacement,
 1 mm. = $0.27''$; M , 25 kg.; L , $92 \pm$ cm.

(3) East component: T_0 , 37 seconds; V , 5; J , 1,700 meters; angular displacement,
 1 mm. = $0.14''$; M , 25 kg.; L , $92 \pm$ cm.

Each one of the Colaba pendulums consists of a mass of about 25 kg., supported on a
 horizontal beam about 90 cm. long. The solid friction is large, sufficient to stop the
 vibration of the pendulum in a single vibration if its amplitude is not more than a few
 millimeters.

	SECOND PRE- LIMINARY TREMORS.	REGULAR WAVES.	MAX.	AMPLI- TUDE.
	<i>min.</i>	<i>min.</i>	<i>min.</i>	<i>mm.</i>
(1) East component . . .	40.8	11.8	34.1	6.3
(2) North component . . .	42.5?	...	27.9	3.5
(3) East component . . .	42.5?	...	29.0	4.0
Average	40.8	11.8		
Interval	28.3	59.3		

Duration, 3.4 hours. (1) gives a better value of the time of arrival of the second
 preliminary tremors than the average on account of the strong friction of (2) and (3);
 and therefore its value is used in preference to the average of the three instruments. The

time of arrival of the regular waves is doubtful; at the time given there is a change in the general character of the record, the irregular phase becoming more regular and the amplitude larger. The friction alters the magnifying power very materially; in the absence of precise knowledge of its value we can not estimate the earth's amplitude.

BATAVIA, JAVA.

Royal Magnetic and Meteorological Observatory. Dr. W. van Bemmelen, acting director.

Lat. $6^{\circ} 11' S.$; long. $106^{\circ} 50' E.$; altitude, 3 meters; distance, 124.99° or 13,897 km.; chord, 11,300 km.; direction, S. $112^{\circ} W.$

Foundation, alluvium.

Seismograms, sheet No. 15.

The instrument used was a Rebeur-Ehler horizontal pendulum, north component; photographic registration. T_0 , 9.4 seconds; V , 65.5; J , 1,440 meters; ϵ , 1.15; M , 200 gm. (?); L , 12.2 cm.

	FIRST PRELIMINARY TREMORS.		SECOND PRELIMINARY TREMORS.		REGULAR WAVES.		MAX.	PERIOD.	AMPLITUDE.	EARTH'S AMPLITUDE.
	<i>m.</i>	<i>s.</i>	<i>m.</i>	<i>s.</i>	<i>m.</i>	<i>s.</i>	<i>min.</i>	<i>sec.</i>	<i>mm.</i>	<i>mm.</i>
North component	32	54	42	16	14	22	30.6	16	6	0.18
Interval	20	26	29	48	61	54				

The instrument was not still when the disturbance arrived; from an examination of the photographic copy of the seismogram it seems probable that the first preliminary tremors began at $29^h 34^m$, giving an interval of 17 minutes 06 seconds. During the regular waves an amplitude of 4.5 mm. was reached at $14^h 17.5^m$, when the earth's amplitude amounted to 0.38 mm. This was the maximum earth movement. During the principal part at $14^h 30.6^m$, the earth-amplitude was 0.24 mm.

KODAIKANAL, MADRAS, INDIA.

Solar Physics Observatory. C. Michie Smith, director.

Lat. $10^{\circ} 14' N.$; long. $77^{\circ} 28' E.$; altitude, 2,343 meters; distance, 127.96° or 14,226 km.; chord, 11,449 km.; direction, N. $26^{\circ} W.$

Foundation, directly on solid rock.

Seismograms, sheet No. 2.

The instrument used was a Milne horizontal pendulum, east component; photographic registration. T_0 , 15 seconds; V , 6.1; J , 340 meters; ϵ , 1.115; r , 0.0 mm.; M , 255 gm.; L , 15.6 cm.

First preliminary tremors, 31.6^m (?); interval, 19.1 minutes (?). Maximum, 28.8^m . Amplitude, 2.5 mm.

The position of this station has been misplaced on the map. It should be about 2 mm. from the southern point of India and equidistant from the sea, east and west.

PERTH, WESTERN AUSTRALIA.

Astronomical Observatory. W. Ernest Cooke, M.A., F. R. A. S., government astronomer.

Lat. $31^{\circ} 57' S.$; long. $115^{\circ} 50' E.$; altitude, 59.5 meters; distance, 132.37° or 14,716 km.; chord, 11,656 km.; direction, S. $78^{\circ} W.$

Foundation, sand on limestones.

Seismograms, sheet No. 2.

The instrument used was a Milne horizontal pendulum, east component; photographic registration. T_0 , 15 seconds; V , 6.1; J , 340 meters; ϵ , 1.083; M , 255 gm.; L , 15.6 cm.

Second preliminary tremors (?), 37.6^m; interval, 25.1 minutes. Regular waves, 18.3^m; interval, 65.8 minutes. Maximum amplitude, 2.0 mm.

A glance at the seismogram will show the difficulty of getting satisfactory determinations of the times of arrival of the first two phases. The beginning at 13^h 37.6^m certainly does not correspond with the beginning of the first preliminary tremors as this phase would be, for moderate and large distances, much weaker than was recorded at Perth; it is possible that this time refers to the second preliminary tremors. The times given accord with the marks on the seismogram; but in Circular 14 of the Seismological Committee of the British Association for the Advancement of Science, the corresponding times are 2.4 minutes earlier.

CAPE OF GOOD HOPE, AFRICA.

Royal Observatory. Sir David Gill, director.

Lat. 33° 56' S.; long. 18° 29' E.; altitude, 7 meters; distance, 148.63° or 16,524 km.; chord, 12,266 km.; direction, S. 86° E.

Foundation, weathered Paleozoic rocks.

Seismograms, sheet No. 1.

The instrument used was a Milne horizontal pendulum, east component; photographic registration. T_0 , 12 seconds; V , 6.1; J , 220 meters; angular displacement, 1 mm. = 0.21"; M , 255 gm.; L , 15.6 cm.

	PRELIMINARY TREMORS.	REGULAR WAVES.	MAX.	AMPLI- TUDE.
East component . . .	<i>min.</i> 36.5 ?	<i>min.</i> 33.5 ?	<i>min.</i> 34.0	<i>mm.</i> 0.2
Interval . . .	24.0 ?	81.0 ?	81.5	

The record is extremely small and is not brought out in the reproduction of the seismogram. On the photographic copy of the seismogram the line shows a slight swelling beginning at 13^h 36.5^m, and a few long-period waves begin at 14^h 33.5^m. It does not appear why this record is so much smaller than those of Perth and Mauritius.

ISLAND OF MAURITIUS.

Royal Alfred Observatory. T. F. Claxton, director.

Lat. 20° 06' S.; long. 57° 33' E.; altitude, 51 meters; distance, 162.02° or 18,012 km.; chord, 12,601 km.; direction, N. 1° W.

Seismograms, sheet No. 2.

The instrument used was a modified Milne horizontal pendulum, two components; photographic registration.

(1) North component: T_0 , 20.4 seconds; V , 11; J , 1,140 meters; ϵ , 1.042; angular displacement, 1 mm. = 0.39"; M , 310 ± gm.; L , 15 cm. (?)

(2) East component: T_0 , 20.4 seconds; V , 8; J , 830 meters; ϵ , 1.007; angular displacement, 1 mm. = 0.25"; M , 340 ± gm.; L , 13 cm. (?)

Preliminary tremors, 41.2^m (?); interval, 28.7^m (?). Regular waves, 36.3^m (?); interval 83.8 minutes (?). Maximum, 50.0^m. Amplitude, 5.0 mm.

Duration, 3.3 hours. The times given do not specify the component, but apparently refer to the east component, as the north seismogram is not very clear. There is a con-

siderable increase in intensity at 13^h 58.3^m, but it is not evident what it refers to. The time of the long waves is very doubtful.

The instrument is an ordinary Milne horizontal pendulum with the beam pointing to the east; to the supporting column a second pendulum is attached pointing south; this is about 10 cm. long and carries a weight. A long light beam carrying the diaphragm is attached at right angles to this pendulum, so that the two records are made side by side on the same photographic paper. The diaphragms are cut down to a width of 6 or 7 mm.; and the slit in the box, thru which the light passes, is closed at intervals of 2 mm., so that a series of white lines appears on the record. One of these white lines lies almost in the center of the record of the north component.

Mauritius is slightly misplaced on the map (plate 1); it should lie in the southeast angle between the lines marking 20° S. latitude and the red north-south line, thru the antipodes of the origin and practically touching these two lines.

THE SEISMOGRAM AND ITS ELONGATION.

EARLIER EXPLANATIONS.

On examining the seismograms, we notice that many of them can readily be divided into a number of well-defined parts. The movement begins as a slight vibration, known as the *first preliminary tremors* or the *first phase*; after an interval, dependent upon the distance of the station from the origin, there is a marked strengthening of the motion; this is called the *second preliminary tremors* or *second phase*; very soon the motion becomes quite irregular. After a second interval, also dependent upon the distance of the station, the irregularities gradually die down, giving place to waves of long period, 25 to 50 seconds, which may have a large amplitude; at many stations the largest earth-amplitudes occur during this phase. The time when these waves take on a fairly regular form can usually be identified with some accuracy and is therefore taken as the time of arrival of the *regular waves*. It is a little later than the *long waves* of Professor Omori and a little earlier than the *large waves* of Professor Milne. I have adopted this point, as I found it in general more easily identifiable, in the various seismograms, than those just mentioned; tho in some seismograms it is difficult to determine accurately where the regular waves begin. In a few cases it is not clear that there are any regular waves at all. This phase does not last long, but it is quickly followed by waves of shorter period, 15 to 20 seconds, during which the pointer is apt to record its greatest amplitude, and which has, therefore, been called the *large waves* or *principal part*; it dies down with more or less irregularity until quiet is restored. This may require several hours, tho the earthquake at the origin may have lasted less than a minute.

A number of hypotheses have been advanced to account for the increasing duration of the disturbance as the distance of the station from the origin is greater. In the first place, it is the general belief, first suggested by Prof. R. D. Oldham,¹ that the first preliminary tremors are due to longitudinal waves, the second preliminary tremors to transverse waves, these two being propagated thru the body of the earth; and that the long waves and principal part are due to waves transmitted along the surface; altho some seismologists think that all waves are transmitted around the earth at or near the surface. A part of the record, near its end, is, in some cases, due to surface waves which have past around the earth and have approached the station from the antipodes.

As longitudinal waves advance more rapidly than transverse the interval between them naturally increases with the distance of propagation. This is the most satisfactory explanation of the increasing interval between the two phases, but according to it we should have two groups of waves separated from each other by a period of quiet; whereas, in reality, we have a continuous disturbance; and, moreover, observation does not confirm the idea that the first and second preliminary tremors consist solely of longitudinal and transverse waves, respectively.

It has also been suggested that repeated reflections from the earth's surface would cause a succession of impulses; but in this case also they would be discontinuous. Still, it is most probable that some of the sudden strengthenings of the movement are due to the arrival of these reflected waves.

¹ On the Propagation of Earthquake Motion to Great Distances. Phil. Trans. R. S. 1900-1901, vol. 194, pp. 135-174.

An explanation has been sought by supposing that waves of various periods are present in the disturbance and that they are propagated at various rates, just as light waves of different wave-lengths travel at different speeds in transparent substances. Altho the slow periods of the regular waves change into the quicker periods of the principal part, this change does not seem to continue during the remainder of the disturbance; nor has a similar change been discovered during the first two phases.

A NEW EXPLANATION.

The passage of sound thru air suggests a better analogy. A strong sound, like the firing of a cannon or a clap of thunder, is not heard at a distance as a sharp noise, but is accompanied by a rumbling that lasts for many seconds; this is due to reflections and refractions of the sound at the surfaces of many layers of air of varying temperature, etc. Now the material of the earth for a few kilometers from the surface consists of rocks of varying density and elasticity; and when an elastic wave crosses the bounding surface between two different materials, it is in general split up into four waves, reflected longitudinal and transverse waves, and refracted longitudinal and transverse waves. When the reflected waves, returning, meet a boundary between different kinds of rock, they are again reflected and send waves forward, which are, however, retarded behind the original wave. In this way, by repeated reflections and refractions, a large part of the energy of the original wave would be, as it were, stored up in the heterogeneous surface layer of the earth and be slowly given out, thus keeping up a continuous supply at the surface for a limited time.

If the whole earth were sufficiently heterogeneous, we should not have, at distant stations, the distinction between first and second preliminary tremors, for there would be thruout the whole course of the waves such frequent transformations from longitudinal to transverse waves and *vice versa*, that they would arrive at a distant station thoroly mixed, and the supply of energy there would be fairly continuous, without the sudden variation which actually marks the arrival of the second phase. But we believe that, with the exception of a surface layer a few kilometers thick, the earth is fairly homogeneous, or, rather, without sudden changes in density or elasticity; and that an earthquake will set up both longitudinal and transverse vibrations, which will travel at different speeds and become entirely separated from each other in the homogeneous interior. When the longitudinal waves reach the heterogeneous layer near the surface they will be broken up; at every refracting surface both longitudinal and transverse waves will be sent forward; as the former always travel the faster, they will arrive first at the earth's surface; but, in general, the transverse waves, set up at the last refracting surface, will not be far behind them. The proportion of longitudinal and transverse waves in the first preliminary tremors, at a given station, will probably depend upon special characteristics of the rock in the neighborhood and also on the direction from which the waves come; for transformations depend on the angle between the vibrations and the refracting surface. In regions of stratified rocks such surfaces are very numerous and are usually parallel with each other; their influence would vary in accordance with the direction in which the vibrations met them. It might thus be possible for the first preliminary tremors to consist almost wholly of longitudinal waves, or to consist of both kinds equally; but it does not seem possible that transverse waves could predominate in them.

Let us now turn our attention to the group of transverse waves traveling by themselves in the homogeneous interior of the earth. They fall farther and farther behind the longitudinal waves; when they reach the heterogeneous outer layer they also suffer transformations, giving rise to both longitudinal and transverse waves, and these, by continual

reflections and refractions, prolong the time during which this group reaches the surface. In this group, as in the first, the proportion of longitudinal and transverse vibrations reaching the surface may vary between wide limits; but the longitudinal waves can never predominate. However, the first vibrations of the group will be longitudinal; for at the first refracting surface which the waves meet longitudinal waves will, in general, be generated, and will immediately advance at a higher speed, always keeping ahead of any transverse waves that they may develop. These waves, like the leaders of the first group, are apt to be weakened by reflections and transformations and may fail of recognition when they are superposed on the later vibrations of the first group. The time of arrival of the first group is dependent on the speed of the longitudinal waves, from start to finish; but that of the second group depends on the speed of transverse waves in the homogeneous interior and of longitudinal waves in the heterogeneous outer layer.

We do not know enough about the interior of the earth to fix the thickness of the outer heterogeneous layer, nor to say whether severe earthquakes originate in it or below it; tho the former seems the more probable. We have for simplicity of statement assumed the latter, but this is by no means necessary. If the earthquake originated in the heterogeneous layer, both groups of waves would suffer some elongation before they reached the homogeneous interior and after they left it; but they would travel without change so long as they were in it. If there is a central metallic core in the earth, changes would, of course, take place when the waves cross its boundary.

THE STRONGER TRANSVERSE WAVES.

If the outer layer of the earth were sufficiently thick or sufficiently heterogeneous, longitudinal and transverse vibrations of the preliminary tremors might become so mixed in it that the first and second phases would not be distinguishable; but nevertheless, the two kinds of waves would separate from each other in the homogeneous interior and at distant stations the two phases would appear. But the fact that the second phase is so much stronger than the first at all stations, including those 30° or 40° from the origin, which are too near for the difference to be accounted for by the vertical component of the longitudinal motion, indicates that the outer homogeneous layer by no means destroys the distinction between longitudinal and transverse waves in the first two phases; and that the transverse waves are originally much stronger than the longitudinal. This may be due to the way in which the waves originate at the fault-surface. When the rupture occurs there, the friction of one side against the other is probably the chief means of starting the vibrations, and evidently would produce stronger transverse than longitudinal waves.

THE SEPARATION OF THE FIRST TWO PHASES.

The distinction of the first two phases would exist from the very start, but they would naturally reach a near station only a few seconds apart; and if the original shock lasted longer than this interval and underwent considerable variations in intensity, the arrival of the first preliminary tremors, due to successive parts of the shock, might mask the arrival of the second. Moreover, and this fact is perhaps still more important, few instruments are provided with very open time-scales, a necessary condition to show the separation of the phases near the origin. Fortunately the Ewing three-component seismograph at Mount Hamilton met this requirement; its time-scale was 6 or 7 mm. to the second and it was therefore quite competent to show the interval of 9 seconds which separated the beginnings of the first two phases. Mount Hamilton, at a distance of 128 km. from the origin, was the nearest station provided with a time-marking record. At Victoria (distant 10.41° or 1,156 km.) the smallness of the time-scale and the overlapping

of vibrations from various parts of the fault-plane make it impossible to recognize the second phase; but at Sitka (20.72° or 2,302 km.), and at more distant stations, the second phase is distinct. So far, therefore, as the observations of the California earthquake are concerned, there is no reason to believe that the first two phases are not distinct from their starting-point; and the reason this has not been recognized heretofore may be entirely due to the small time-scale of the instruments.

THE DIRECTION OF MOTION.

Let us see how far the observed directions of motion support the above explanation of the elongation of the first two phases. The duplex seismographs of Berkeley and Mount Hamilton indicate the direction of the beginning of the motion; they show that the first movement of the ground at these stations was directed away from the origin. The extent of the fault-surface soon caused waves to come from many directions, so that the recorded movement became confused almost immediately; but at Mount Hamilton there were two longitudinal vibrations before other waves materially interfered with their direction. The seismogram of the three-component Ewing instrument shows, when we consider the arrangement of the recording pens, that the first and second preliminary tremors began there with a movement southeast and northwest, that is, along the direction of propagation. These two were the only stations near the earthquake's origin which yielded definite information regarding the direction of motion at the beginning of the shock. And of all the records at distant observatories there are comparatively few which throw light on this subject; because only a very few instruments were so oriented as to record separately the vibrations parallel with, and at right angles to, the course of the waves. The stations in the eastern part of the United States were well situated for this purpose, as the waves were moving almost directly eastward when they past them. Ottawa and Cheltenham each recorded the longitudinal waves (east component) about 13 seconds before the transverse, and the longitudinal waves also were somewhat stronger during the first preliminary tremors. In the second group, transverse waves (north component) were recorded at Cheltenham 9 seconds earlier than the longitudinal; and they seem very slightly stronger. The northern component of the second group in the Ottawa seismogram overlaps other parts and can not be clearly read; but it seems to be somewhat stronger than the eastern component. The Albany record does not yield definite results, and the other stations in this neighborhood only recorded one component of the motion.

The waves arrived at the majority of the European observatories in a direction making angles between 30° and 40° with the meridian; and as by far the larger number of the instruments recorded either north-south or east-west motion, they would be affected about equally and would not distinguish between longitudinal and transverse waves. A few instruments, however, were oriented so as to make the distinction. The triple Ehlert instrument at Uccle began to record at the same moment with all three components, but the longitudinal waves (N. 60° W.) were stronger during the first preliminary tremors, and the transverse (N. 60° E.) during the second preliminary tremors. At Kremsmünster the longitudinal waves (distributed between the two components, N. 13° W. and N. 73° W.) seem stronger during the first preliminary tremors, and the transverse (N. 47° E.) during the second preliminary tremors. At Rocca di Papa the longitudinal vibrations (NW.) in the second preliminary tremors were registered 42 seconds before the transverse (NE.), according to Professor Agamennone's reading of the original record. At Messina, the transverse (NE.) vibrations in the second preliminary tremors were somewhat stronger than the longitudinal.

The waves approach Taschkent and Jurjew making a small angle with the meridian. No difference can be made out for the two components during the first and second preliminary tremors at Taschkent, but at Jurjew the east-west component was larger for both. The waves approach Mauritius exactly from the north; and it is the most distant station from the origin (162°). The earlier part of the motion was distinctly stronger on the north-south component; and this preponderancy lasted during the first part of the second preliminary tremors; but it must be remembered that the time of beginning of this phase is somewhat doubtful. On the other hand, we find the east-west motion, at Tacubaya, stronger for the first two phases, altho the direction of propagation was practically symmetrical with respect to the two components. At Upsala the east-west movement was slightly more marked during the first preliminary tremors and the north-south during the second preliminary tremors, tho the opposite would have been expected. At Potsdam, Jena, and Göttingen the north-south movement was slightly the stronger during the second preliminary tremors, also contrary to expectation.

This is the very meager evidence which the records of the earthquake offer regarding the direction of motion during the preliminary tremors. It is not entirely consistent, but it indicates on the whole that longitudinal vibrations were preponderant during the first preliminary tremors, and transverse during the second preliminary tremors; but that both kinds of motion existed practically during the whole of the preliminary tremors; and therefore the evidence can be said to favor the theory advanced to explain the drawing out of the record.¹

We must remember that transverse vibrations may have any direction around the direction of propagation, and in particular may lie in the vertical plane thru this direction; the horizontal projection of their motion would then lie in the direction of propagation of the disturbance along the surface, and they would be recorded as tho they were longitudinal waves. This may explain the longitudinal direction of the strong motion at Mount Hamilton, tho the movement on the fault-plane would lead us to expect transverse waves more nearly in a horizontal plane.

THE PRINCIPAL PART AND THE TAIL.

It is generally believed that the surface waves are also drawn out more and more as the distance of the station is greater; but an examination of the seismograms of the California earthquake does not support this view. It is very difficult to determine what should be considered the principal part and what the tail portion of the seismogram; but on making the best estimate we can of the principal part, we find no regularity in its duration; and we also find very different results according to the type of instrument recording. For instance, at Taschkent, one would estimate about 2.5 hours for the principal part from the Repsold-Zöllner instrument, and 15 minutes from the Bosch-Omori. At Baltimore (distant 35.7°) a Milne pendulum makes the duration of the principal part about 47 minutes; whereas Bosch-Omori instruments at Washington (35.4°) and Cheltenham (35.6°) indicate a duration of only 6 to 8 minutes. At San Fernando (85.25°) a Milne pendulum gives a duration of 45 minutes; at Krakau (85.98°) a Bosch-Omori, subject to some solid friction, gives 5 minutes; and at Vienna (86.37°) a Wiechert inverted pendulum gives 13 minutes. The following table, in which the duration of the principal part is given in minutes, is made up from the records of Milne pendulums alone, and shows that even the same type of instrument does not yield consistent results.

¹ Prof. C. F. Marvin (Monthly Weather Review, 1907, vol. xxxv, p. 5) obtained very interesting results regarding the direction of vibration at Washington at the time of the Jamaican earthquake, January 14, 1907. The longitudinal vibrations began earlier and were much the stronger during the preliminary tremors; the transverse vibrations were much the stronger during the principal part.

TABLE 6. — Duration of the Principal Part as Recorded by Milne Instruments.

STATION.	DISTANCE.	DURATION.	STATION.	DISTANCE.	DURATION.
Victoria . . .	10.4	49	Kew	77.6	25 or 36
Toronto . . .	32.9	32	Irkutsk	80.8	28 or 60
Honolulu . . .	34.6	62	Coimbra	81.4	24
Baltimore . . .	35.7	47	San Fernando . .	85.3	54
Paisley	72.6	29	Calcutta	112.7	31
Edinburgh . . .	73.0	35	Bombay	121.2	26
Bidston	74.8	36	Perth	132.4	60

It is quite evident that no conclusion regarding the variation in duration of the principal part at different distances from the origin can be drawn from such data.

But, altho we may be unable to recognize a progressive change in the duration of the principal part; nevertheless it is quite certain that all seismographs register a strong motion lasting much longer than the original shock. What has been called the *violent shock*, and which alone could have affected distant seismographs, did not last more than 40 or 50 seconds; whereas the recorded principal part certainly lasted many minutes and in some cases an hour. This may be in part due to the synchronism of the periods of the waves and the instruments, but it can not be entirely explained in this way and it must be lookt upon as not yet understood.

We have a little information regarding the prevalent direction of motion during the principal part. At Ottawa, Cheltenham, and Albany the longitudinal waves retained their intensity for a longer time than the transverse, tho we can not say which attained the greater maximum. At Rocca di Papa the longitudinal waves attained the greater maximum, but the durations of the two were about the same. At Messina the longitudinal waves were stronger and lasted longer than the transverse. On the other hand, the transverse waves lasted longer at Florence, and they had a greater maximum at Caggiano. The observations are very meager and very inconsistent; evidently more careful observations must be made to show to what extent the longitudinal and transverse waves are characteristic of different parts of the seismogram, how far this quality is different at different stations, to what variations it is subject, and what are their causes.

The long tail portion of the seismogram is still a riddle; and altho we can hardly help considering it as in some way due to waves following different paths and to reflections, we shall see further on (page 124) that simple reflections will not explain it. One may easily be misled in attempting to correlate certain movements on different seismograms; for instance, the last marked broadening of the trace of the Paisley, Edinburgh, and Bidston seismograms (sheet No. 1), occurring a few minutes before 14^h 30^m, is so similar that one would naturally suppose that they represent a special group of progressive waves; on determining the times of occurrence we find for its maximum, 14^h 14.7^m, 14^h 20^m and 14^h 26.1^m at the three stations respectively; the difference in time at Paisley and Bidston is 11.7 minutes and the difference in distance 252 km.; therefore the velocity of propagation would be 22 km./min. But the time for them to reach Paisley from the focus, a distance of 8,060 km. would be 62.2 minutes, requiring a velocity of 130 km./min. These values are so different that we must regard this broadening of the trace as due to some accidental synchronism of periods at the three stations, and not to an objective characteristic of the disturbance itself. There are many difficulties in understanding the characteristics of the seismogram which have not been overcome; and it is not likely that we shall have a complete explanation of it until a large number of heavily damped seismographs are installed, whose records will correspond closely with the actual movements of the earth, and will not be materially affected by the peculiarities of the instrument itself.

THE PROPAGATION OF THE DISTURBANCE.

THE HODOGRAPHS

All the available data which has been obtained bearing on the velocity of transmission has been collected in table 7 and exhibited graphically in plate 2. It will be seen that by far the larger number of observations occurred at distances between 70° and 100° from the origin. Many of the stations are at so nearly equal distances that they have been grouped together and entered as a single observation in the plate; therefore the number of observations marked on the plate is considerably less than the number actually represented. All the seismograms have not the same degree of accuracy, and different symbols have been used to indicate these differences; the observations from some stations are less reliable on account of the difficulty in reading the seismogram; in some cases, less confidence can be given to the record because the seismogram was not at hand to confirm it; this applies with special force to the observations of the regular waves, for there is no general consensus of opinion as to the particular point of the seismogram that indicates their beginning. The curves drawn in the plate show the times taken for the three phases to travel from the origin to the distance of the observing station, these distances being indicated in degrees and kilometers. The stations are marked at the bottom, singly or in groups; occasionally some stations of a group fail to yield satisfactory determinations of the time of arrival of a phase of the disturbance; this phase is then marked with the initials of the stations which recorded it.

TABLE 7. — *Times of Transmission of the Various Phases.*
 [1 P. T. = First preliminary tremors.] [2 P. T. = Second preliminary tremors.]
 [R. W. = Regular waves.] [P. P. = Principal part.]

STATION.	ARC.		CHORD.	TIME INTERVAL, IN MINUTES AND SECONDS.							
				1 P. T.		2 P. T.		R. W.		P. P.	
				m.	s.	m.	s.	m.	s.	m.	s.
Mount Hamilton	1.16	128	129	0	17	0	26
Victoria	10.41	1157	1156	2	14
Sitka	20.72	2303	2291	4	34	8	38	10	04
Tacubaya	27.70	3081	3050	5	30	10	24	13	09	13	37
Toronto	32.93	3571	3610	6	48	12	00	15	24
Honolulu	34.60	3846	3790	7	00	11	54?
Ottawa	35.38	3932	3871	6	51	12	22	18	30
Washington	35.44	3939	3878	6	52	12	32	16	52	18	00
Cheltenham	35.64	3962	3899	6	55	12	37	17	48	20	00
Baltimore	35.74	3973	3909	6	54	12	42	19	06
Average	35.55	3952	3889	6	53	12	33	17	20	18	54
Albany	37.13	4128	4056	9	02	16	04	20	17	21	12
Porto Rico	53.45	5942	5729	9	22	17	39
Trinidad	60.94	6774	6460	29	30
Apia	69.20	7694	7235	10	54	19	56
Mizusawa	70.46	7834	7349	11	39	20	46
Ponta Delgada	72.53	8064	7536	11	06	38	00
Paisley	72.54	8065	7537	10	42	20	48	34	54	38	30
Bergen	72.79	8092	7560	10	23	19	47	39	16
Edinburgh	72.99	8115	7578	11	00	20	30	35	30	39	30
Average	72.71	8079	7553	10	48	20	22	35	12	38	48
Tokyo	73.92	8217	7660	12	07	21	56	33	52	37	47
Bidston	74.81	8317	7739	11	48	21	30	35	42	39	06
Average	74.37	8267	7700	11	58	21	43	34	47	38	28
Upsala	76.80	8538	7914	12	23	22	16	37	52	40	34
Shide	77.08	8569	7938	11	48	21	44	38	08
Osaka	77.30	8594	7957	11	56	21	45	35	28
Kobe	77.54	8619	7976	11	55	21	51	37	52
Kew	77.63	8630	7986	21	30	37	30
Average	77.27	8590	7954	12	00	21	49	37	22

TABLE 7.—*Times of Transmission of the Various Phases.*—Continued.

STATION.	ARC.		CHORD.	TIME INTERVAL, IN MINUTES AND SECONDS.							
				1 P. T.		2 P. T.		R. W.		P. P.	
	°	km.		m.	s.	m.	s.	m.	s.	m.	s.
Hamburg	79.74	8866	8167	12	04	22	22	39	17
Uccle	79.80	8872	8173	11	59	22	29
Jurjew	80.27	8924	8212	12	15	22	18
Irkutsk	80.82	8986	8259	12	08	22	22	38	48
Average	80.16	8912	8203	12	06	22	23	39	02
Potsdam	81.35	9042	8303	12	22	22	55	39	21	42	22
Göttingen	81.36	9046	8304	12	16	22	38	38	37	44	08
Coimbra	81.39	9049	8307	12	54	22	30	38	00
Average	81.37	9046	8305	12	31	22	47	38	39	43	15
Leipzig	82.40	9161	8392	12	22	23	11	38	53	43	02
Jena	82.45	9167	8396	12	06	22	41	38	44	44	11
Strassburg	82.91	9218	8434	12	29	22	52
Average	82.59	9182	8407	12	19	22	55	38	48	43	36
Munich	84.75	9423	8587	12	32	23	06	39	15
San Fernando	85.25	9478	8628	12	36	22	48
Average	85.00	9451	8541	12	34	22	57	39	15
Tortosa	85.65	9522	8660	12	27	23	32	42	32
Kremsmünster	85.77	9535	8670	11	54	23	00
Krakau	85.98	9558	8687	23	14	41	38	45	07
Granada	86.08	9570	8696	12	12	22	52	42	11
Pavia	86.20	9583	8707	12	28	22	38	41	32	48	27
Vienna	86.37	9602	8719	12	47	23	40	41	18	45	05
Average	86.01	9562	8690	12	18	23	09	41	50
Laibach	87.22	9697	8786	13	06	23	02	41	42
Triest	87.74	9754	8828	12	41	23	08
O'Gyalla	88.08	9792	8856	12	52	23	40
Florence (Ximeniano)	88.23	9808	8868	13	57	24	36
Zagreb	88.33	9820	8876	12	57	23	03	40	48
Pola	88.34	9821	8877	13	28	23	45	41	46
Quarto-Castello	88.40	9828	8882	14	10	24	36	39	33
Zi-ka-wei	88.49	9838	8889	12	56	23	08	43	32
Pilar	88.75	9866	8909	13	06
Average	88.17	9803	8864	13	17	23	37	40	57?
Rocca di Papa	90.48	10061	9046	24	02	45	02
Belgrade	90.67	10080	9061	24	26
Average	90.58	10070	9054	24	14	45	02
Ischia	91.84	10210	9152	14	14	24	30	43	56
Caggiano	92.63	10297	9213	24	12	44	18
Taihoku	92.75	10311	9222	16	24?	43	52
Sofia	93.58	10404	9286	12	32?	23	17?	44	38
Messina	94.67	10524	9368	43	00?
Catania	95.04	10567	9396	13	37	23	57?	44	38	53	20?
Wellington	97.62	10853	9588	14	06	24	18	49	42?
Calamate	98.28	10927	9636	49	38
Tifis	99.43	11054	9719	13	41	25	31
Taschkent	99.86	11102	9750	14	00	24	54
Average	99.65	11078	9735	13	50?	24	12?
Christchurch	100.40	11162	9788	21	06	48	30
Manila	100.46	11169	9793	10	16?	48	30?
Average	100.43	11165	9790	10	16?	21	06	48	30?
Tadotsu	101.30	11262	9852	12	39?
Cairo	107.92	11998	10302	18	30	26	30?
Calcutta	112.72	12531	10607	16	42?	26	54	53	06
Bombay	121.19	13472	11099	28	18	59	18
Batavia	124.99	13897	11300	20	26?	29	48	61	54
Kodaikanal	127.96	14226	11449	19	06?
Perth	132.37	14716	11655	25	06?	65	48
Cape of Good Hope	148.63	16524	12256	24	00?	81	00?
Mauritius	162.02	18012	12601	28	42?	83	48

After plotting in the times of arrival of the three phases at the various stations a smooth curve is drawn thru the points marked, so that the errors of the observations may be as small as possible; the velocity of the first preliminary tremors, as noted on page 7, is assumed to be 7.2 km./sec. near the origin; the velocity of the second preliminary tremors in the same region becomes 4.8 km./sec. from the Mount Hamilton observations, as they begin there 9 seconds after the first preliminary tremors. A special method was followed in drawing the straight line for the long waves and it will be given further on. These curves are called "hodographs." The average velocity of transmission to any station is evidently given by the time interval divided by the distance; that is, it would equal the tangent of the angle which a straight line, drawn from the origin to a point on the hodograph immediately above the station, makes with the vertical; and the velocity along the surface would be given by the difference between the times of arrival at two stations divided by the difference of their distances from the origin, provided these distances differed but little from each other.

THE PRELIMINARY TREMORS.

The first thing that strikes us on examining the plate is that the hodographs of the first two phases are curved, indicating that the average velocity of transmission increases with the distance; and that the hodograph of the regular waves is straight, showing a constant velocity independent of the distance. These distances have been measured along the surface, or, as it is expressed, along the arc. When we plot the hodographs of the first two phases in terms of the distance of the stations from the origin, measured by the shortest route, that is, by the chord, as shown in the upper part of the plate, we find them still curved, but much less so than in the former case. It is the general belief that the curvature of these lines indicates that the waves travel thru the body of the earth and that their velocity increases with the depth of the path below the surface; if this be true, and no satisfactory arguments have been advanced against it, the waves would not follow the shortest path to a station, that is the chord, but would follow a curved path, convex downward, which would bring them to the station in the shortest time. Unfortunately at distances greater than 100° for the first preliminary tremors and 125° for the second preliminary tremors, the observations of the phases become extremely doubtful; and it is precisely the paths leading to stations beyond these distances that dip very deep towards the center of the earth, and that might reveal the nature of that region.

The cause of the inaccuracy of observations at great distances is not far to seek. The first preliminary tremors are always very weak and are recorded as very small vibrations even at comparatively small distances. If, moreover, as we have given reasons to believe, their vibrations are longitudinal, a large part of their energy would be taken up in vertical vibrations at the surface, particularly at great distances, and would therefore fail to produce an appreciable disturbance of instruments recording horizontal movements only. The horizontal and vertical components of the first preliminary tremors at Göttingen (distant 81.36°) have about the same amplitude, which is very small; and this shows that the weakness of this phase is not merely due to its tendency to produce vertical vibrations at the earth's surface. Moreover, the amplitude of vibrations would decrease more rapidly than the distance, because, as Prof. C. G. Knott¹ has shown, the curved paths of these waves would cause the energy to be concentrated upon the nearer stations, with a corresponding diminution at the more distant ones. It also happens that all the instruments at stations beyond 105° have a low magnifying power, with the exception of Batavia; and even there the magnifying power, 65.5, may be insufficient to indicate the real beginning of the first preliminary tremors. It is quite possible that the beginning of the record at Mauritius may represent the second preliminary tremors, and that the

¹ The Physics of Earthquake Phenomena, p. 253.

hodograph should pass exactly thru the records of Calcutta and Mauritius; but this is too uncertain to justify the extension of the hodograph to Mauritius. It does not seem to be possible, from the observations of this earthquake, to draw any certain inference regarding the velocity of propagation of the first two phases much beyond 110° .

The beginning of the second preliminary tremors is often the most easily recognizable point of the seismogram. The first preliminary tremors frequently have so small an amplitude that their beginning can not be determined; and sometimes there is no evidence of any movement until the second preliminary tremors arrive. The latter usually show themselves by a definite and well-marked increase in the amplitude of the recording instrument.

The records of the Kingston earthquake of January 14, 1907, offer a very instructive example of the influence of the magnifying power of seismographs on the times recorded. Washington, with a magnifying power of 25, recorded the first preliminary tremors; Cheltenham, with a magnifying power of 10, began its record with the second preliminary tremors; whereas Baltimore, with a magnifying power of 6, only recorded the principal part. These three stations are close together and practically at the same distance from Kingston.

The hodograph of the second preliminary tremors, expressed in terms of the distance measured along the chord, shows a point of inflection at a distance of about 9,000 km.; this does not indicate that the average velocity diminishes at this distance, but merely that it does not increase as rapidly as it does at shorter distances; this part of the curve, however, is quite doubtful and we are not justified in drawing any very definite conclusion from its form. It is extremely disappointing that the observations of this earthquake do not lead to definite results regarding the propagation of the disturbance to very great distances; for the point where the earthquake occurred and the time of its occurrences are both known to a satisfactory degree of accuracy, and instruments recorded the shock at stations as far as 162° distant, that is, very nearly to the antipodes. This further emphasizes the importance of installing instruments recording the vertical component of motion, and instruments with high magnifying powers, not less than 100; for they alone can be expected to yield satisfactory records of the times of the arrival of the various phases of very distant earthquakes, regarding which our information is still very vague.

As the earthquake originated at some distance below the surface, the surface velocity in the immediate neighborhood of the epicentrum would be very large; it would diminish rapidly as the distance increased, would reach a minimum and again increase as the paths of the waves to the more distant stations extended deeper into the earth. If we had absolutely accurate observations, the hodograph, drawn from them, would be concave upwards near the origin, would pass thru a point of inflection a little further off, and would then pass into the general form, concave downwards, as drawn in the plate. Seebach¹ first pointed out that the form of the curve in the neighborhood of the origin could be used to determine the depth of the focus; he assumed constant velocity in all upward directions near the origin; Prof. A. Schmidt,² assuming increasing velocity with the depth, modified the results; but the degree of accuracy required of the observations is so great that all attempts so far made to determine the depth of the focus by this means are unreliable; and we can not expect to apply the method successfully until the accuracy of our observations is far greater than it is now. Table 8 shows the distances of stations from the centrum in kilometers, in terms of their distances from the epicentrum measured along the surface of the earth, and of the depth of the centrum; these distances take into account the curvature of the earth and are accurate to a fraction of a kilometer.

¹ Das Mitteldeutsche Erdbeben von 6 Mars 1872. Leipzig, 1873.

² Wellenbewegung und Erdbeben. Jahreshfte für Vaterlands Naturkunde in Württemberg, 1888, p. 248.

Table 9 shows the differences in the time of arrival in seconds, of the first preliminary tremors at stations at various distances, when the focus is at the given depth or at the surface, calculated under the supposition that the velocity is 7.2 km. / sec. Table 10 gives similar results for the second preliminary tremors, whose velocity is taken at 4.8 km. / sec. (see p. 117). In these tables z is the depth of the focus and D the distance of the station from the epicentrum measured along the earth's surface, in kilometers.

TABLE 8. — *Distances from the Centrum (in kilometers).*

$z \backslash D$	10	20	50	100	200	400
0	10.0	20.0	50.0	100.0	200.0	400.0
10	14.1	22.3	51.0	100.5	200.2	399.8
20	22.3	28.3	53.8	101.9	200.8	399.9
50	51.0	53.8	70.6	111.5	205.5	401.5
100	100.5	101.9	111.6	141.3	222.3	409.3

TABLE 9. — *Differences between the Times of Arrival of the First Preliminary Tremors when the Focus is at the Surface or at the Depth z (in seconds).*

$z \backslash D$	10	20	50	100	200	400
10	0.6	0.2	0.1	0.0	0.0	0.0
20	1.6	1.2	0.5	0.3	0.1	0.0
50	5.7	4.7	2.9	1.6	0.8	0.2
100	12.6	11.4	8.6	5.7	3.1	1.3

TABLE 10. — *Differences between the Times of Arrival of the Second Preliminary Tremors when the Focus is at the Surface or at Depth z (in seconds).*

$z \backslash D$	10	20	50	100	200	400
10	0.9	0.5	0.2	0.0	0.0	0.0
20	2.6	1.7	0.8	0.4	0.2	0.0
50	8.5	7.0	4.3	2.4	1.1	0.3
100	18.9	17.0	12.8	8.6	4.6	1.9

A glance at these tables will show that, for any probable depth of focus, stations at a distance from the origin of two or three times this depth would be wholly incapable of supplying time records which could be used in determining the depth. Let us take an example. Suppose the focus of an earthquake was at a depth of 50 km., and that it was recorded at two stations, one 50 km. and the second 100 km. distant from the epicenter; the first would record it 2.9 seconds and the second 1.6 seconds later than if the earthquake had occurred at the same time at the surface. The difference of these numbers, namely, 1.3 seconds, is the difference in the interval between the recorded times at the two stations, for earthquakes at a depth of 50 km. and at the surface. It would be quite impossible to determine so small a difference with any instruments now in use, and therefore such observations could only tell us that the depth was probably not much greater than 50 km. But an accurate record at a station, say, 200 km. distant from the origin might be used in connection with the records of nearer stations, to show that the focus was not very deep. In our determination of the location of the focus of the California earthquake we had observations of four stations, and by the method of least squares we found its most probable location. The observations at Ukiah and Mount Hamilton had no practical influence in determining the depth, but helped to locate the epicenter; whereas the observations at the nearer stations determined the approximate depth.

The actual points of inflection of the hodographs are not so very near the epicenter, their distances being 252, 357, 463, and 796 km. for the depths of focus 10, 20, 50, and

100 km., respectively; but the curvature of the lines practically disappears at distances from the epicenter equal to twice the depth of the focus.

Professor Rizzo has made strong inflections in his hodograph of two Calabrian earthquakes.¹ A straight line would fit the observations of the first preliminary tremors in the first earthquake to distances of 2,000 km. rather better than his curves, especially for the near stations; and the observations which bend the hodograph of the first preliminary tremors in the second earthquake are far too inaccurate to justify the curve. The observations of the second preliminary tremors in both cases are too few to be decisive. Moreover, the points of inflections of the curves are at a distance of about 800 km., which would correspond to a depth of focus of about 100 km.; whereas Professor Rizzo does not think the depth in either case greater than 50 km.

The curvature of the hodographs near the origin has not been shown in plate 2 because the scale is too small. The times given by the curves are measured from the time the earthquake occurred, as nearly as this could be determined, and not from the time the disturbance reached the surface at the epicenter, as has usually been done. There are certain objections to the usual method; the disturbance does not pass from the focus directly to the surface and then along the surface to distant points, but it goes directly to the distant points, and its time of arrival there, even at such short distances as four times the depth of the focus, is not materially affected by this depth, tho the time of arrival at the surface is. It is better, therefore, for our base-line to represent the time of occurrence of the shock at the focus; and if the scale of the drawing is sufficiently large to show the upward curvature of the hodograph, the curve would not pass thru the origin but above it, at a distance representing the time necessary for the shock to go from the focus to the surface. This will be only a few seconds; perhaps never more than 7 seconds for the first preliminary tremors and 10 seconds for the second preliminary tremors, as these intervals would correspond to a depth of focus of 50 km.

In table 11 are shown the velocities of the first preliminary tremors and second preliminary tremors in kilometers per second, measured along the chord. The velocities are not calculated from actual observations at the stations, but from the hodographs.

TABLE 11.— *Velocities of First and Second Preliminary Tremors in Kilometers per Second along the Chord.*

DISTANCE.			FIRST PRELIMINARY TREMORS.		SECOND PRELIMINARY TREMORS.	
Degrees.	Arc.	Chord.	Interval.	Velocity, chord.	Interval.	Velocity, chord.
°	km.	km.	min.		min.	
0	0	0	0.0	7.2	0.0	4.8
10	1112	1110	2.4	7.7	3.85	4.8
20	2224	2212	4.3	8.6	7.6	4.9
30	3335	3297	6.1	9.0	10.9	5.0
40	4447	4357	7.7	9.4	13.8	5.3
50	5559	5384	9.0	10.0	16.3	5.5
60	6671	6370	10.2	10.4	18.6	5.7
70	7783	7307	11.35	10.7	20.6	5.9
80	8894	8189	12.3	11.1	22.25	6.1
90	10006	9009	13.25	11.3	24.0	6.2
100	11118	9759	14.2	11.4	{ 25.7	6.3
					{ 25.4	6.4
110	12230	10436	14.9	11.7	{ 27.2?	6.4?
					{ 26.5?	6.6?
120	13342	11033	{ 28.5?	6.5?
					{ 27.3?	6.7?
130	14453	11546	{ 29.8?	6.5?
					{ 27.8?	6.9?

¹ Sulla Velocità di Propagazione della Onde Sismiche, Acad. R. d. Scienze di Torino, 1905-06, vol. LVII, pp. 309-350; Nuovo Contributo allo Studio della Propagazione dei Movimenti Sismici, same, 1907-08, vol. LIX, pp. 375-419.

Two sets of values of the second preliminary tremors are given for distances of 100° or more; they correspond to the two curves drawn in plate 2. The first set are more in accord with the observation at Batavia, the second with that at Mauritius; but both are very doubtful beyond about 110° , where they do not differ much.

THE PATHS OF THE WAVES THRU THE EARTH.

The velocities given show the average values between the focus and the distance indicated; but they do not show the actual velocity at any point of the path. The average velocity increases with the distance of the station; and this must be due to increasing velocity with greater depth below the surface. With such increasing velocities it is impossible for the rays to follow straight lines, but they must follow paths which are concave upwards. Prof. E. Wiechert¹ has given a method for following out the paths of the waves, which is dependent upon the direction of the wave as it approaches a station. The angle at the station between this direction and the surface is the angle of emergence, e , and its complement is the angle of incidence, i (see fig. 27). This angle may be found immediately if we know the velocity of the wave near the surface and the surface velocity. The former is about 7.2 km./sec.; the latter can be determined from the hodograph; it equals the angle made with the vertical by the tangent line to the hodograph. The value of the surface velocity depends, therefore, upon the actual direction of the hodograph line (plate 2), and can only be determined accurately provided the hodograph is accurate. This, however, is by no means true, so that our values for the surface velocity are only approximately correct. The paths of the waves depend upon the angles of emergence, and as they are only approximate the same is true of the paths. They, however, represent fairly well the course of the waves as they travel thru the earth to stations at various distances. Following Professor Wiechert's method these paths have been drawn in fig. 27, the full lines representing the first preliminary tremors and the broken lines the second preliminary tremors. The paths have been drawn for the first preliminary tremors leading to distances up to 110° and for the second preliminary tremors to 100° ; these are the limiting distances to which our hodographs yield fairly good values.

It will be seen that the paths have a very marked curvature, especially those leading to stations which are not very distant. The paths leading to points less than 70° distant are less curved for the second preliminary tremors than for the first preliminary tremors; but the opposite is true for paths leading to greater distances. The paths of both groups leading to this particular distance are practically coincident. As the waves penetrate deeper into the earth their paths become less curved; and the path leading to the antipodes thru the earth's center would be a straight line.

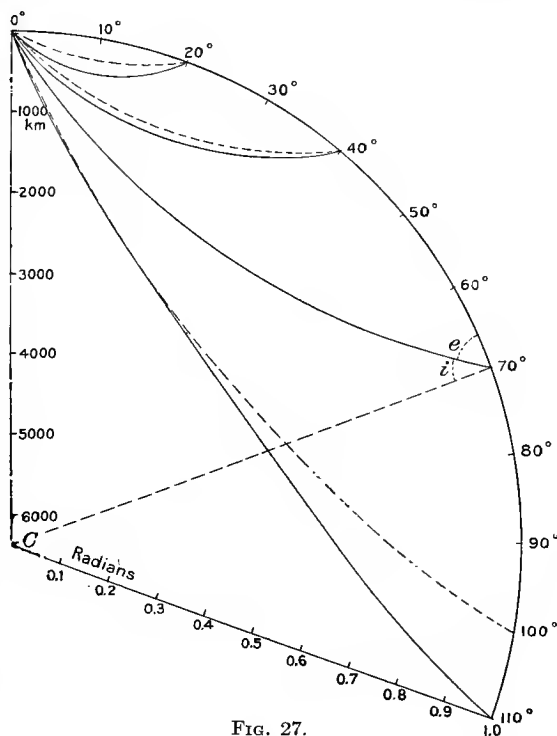

FIG. 27.

¹ Ueber Erdbebenwellen. Nach. d. K. Gesells. d. Wissens. zu Göttingen, Math.-phys. Kl., 1907.

RELATION OF THE VELOCITY TO THE DEPTH BELOW THE EARTH'S SURFACE.

Professor Wiechert's method enables us to determine the velocities at different depths below the surface. For any point on a given path we have

$$\frac{r \sin i}{v} = \frac{\bar{r} \sin \bar{i}}{\bar{v}}$$

where r is the distance from the center of the earth, i the angle which the path makes with the radius, and v the velocity; the letters in the second member refer to the same quantities at the point where the path comes to the surface.

TABLE 12.—Surface Velocities and Angles of Emergence.

FIRST PRELIMINARY TREMORS.			SECOND PRELIMINARY TREMORS.		
Distance.	Surface velocity.	e	Distance.	Surface velocity.	e
°	Km. sec.	° /	°	Km. sec.	° /
0	3.9	0 00	0	2.6	0 00
20	5.5	44 51	20	2.95	28 06
40	6.9	55 19	40	3.75	46 22
70	9.4	65 46	70	5.45	61 42
110	13.1	72 40	100	7.5	69 51

In table 12 we have collected together the values for the surface velocities and for the angle of emergence e , for points at several distances from the origin; and from these data we can calculate the velocity at the points where the respective waves reach their greatest

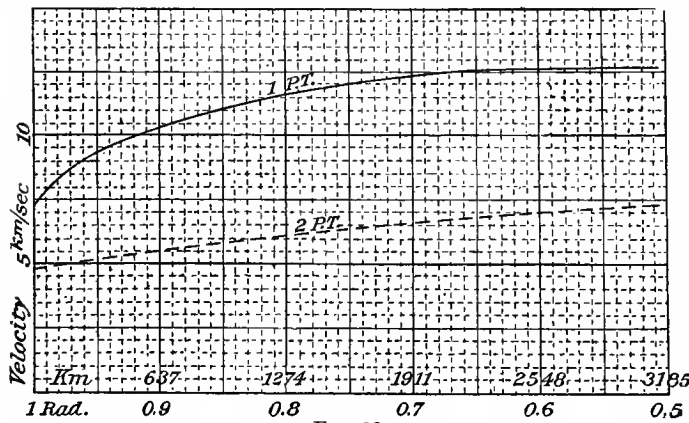

FIG. 28.

it was found that the time the wave would take to traverse the path did not correspond exactly with the time given by the hodograph. The velocities were slightly altered and, by the method of trial and error, new values were found which would make the time intervals correspond to those given by the hodographs. The changes in the velocities were small. These velocities are shown in table 13 in the column headed u , and graphically in fig. 28. The velocity increases with the depth below the surface, but more and more slowly as the depth becomes greater. There is no indication of a sudden change in the velocity, such as we should expect if there were any sudden changes in the nature of the earth's interior, but it must be remembered that the greatest depth reached by the deepest path we have drawn is only about halfway to the earth's center, and that our values, especially for the deeper paths, leave much to be desired in accuracy; indeed, the

depths. At these points the paths are at right angles to the radius and $\sin i$ is 1. The value of r can be measured in fig. 27 and the value of v determined. This process was carried out and the values of v given in table 13 were found. These values were plotted on section paper and a smooth curve drawn thru them representing the velocity as a function of the depth. On applying these velocities to the various parts of each path

TABLE 13.—*Velocities of Earthquake Waves at Various Depths below the Earth's Surface.*

DISTANCE BETWEEN ENDS OF PATH.	DISTANCE FROM EARTH'S CENTER, RADIAN.	DEPTH BELOW SURFACE. (km.)	FIRST PRELIMINARY TREMORS.		SECOND PRELIMINARY TREMORS.	
			<i>v</i>	<i>u</i>	<i>v</i>	<i>u</i>
0	1	0	7.2	7.2	4.8	4.8
20	{ 0.93	435	9.4	9.75
	{ 0.955	280	5.2	5.25
40	{ 0.845	980	10.7	11.1
	{ 0.862	870	6.0	5.8
70	{ 0.693	1960	12.0	12.4
	{ 0.693	1960	6.8	6.65
100	0.524	3020	7.3	7.2
110	0.512	3150	12.25	12.7

results we have reached can only be looked upon as fair approximations to the truth; and we need more numerous and more accurate determinations of the times of transmission of earthquake waves, especially to great distances, before we can reach a satisfactory knowledge of the velocity of propagation at various depths.

INTERNAL REFLECTIONS.

When the waves of the first two phases come to the surface of the earth they are reflected, and as the density of the air is insignificant in comparison with that of the rock, practically none of the energy escapes into the air. But the reflected energy will be divided between two waves, a longitudinal and a transverse, each of which, therefore, will be weaker than the original waves.¹ Waves will reach a given station, *S* (fig. 29), after a single reflection, from three points on the arc between the focus and the station. The first is the half-way point *B*; from this point an incident longitudinal wave will send a reflected longitudinal wave and an incident transverse wave will send a reflected transverse wave to the station. The second is the point *C*, where the reflected transverse waves, due to incident longitudinal waves, pass off in the proper direction at an angle of reflection smaller than the angle of incidence, because their velocity is less than that of the longitudinal. The third point is *D*, where the transverse waves are transformed into longitudinal waves, which pass on to *S*. There would also be three analogous points *B'*, *C'*, *D'*, on the major arc. When we consider waves which reach *S* after two reflections, we see that they may follow many different paths, as they transform by reflection from one type of wave to the other; there are of course two points, situated at one-third and two-thirds the distance to the station, where reflections can take place

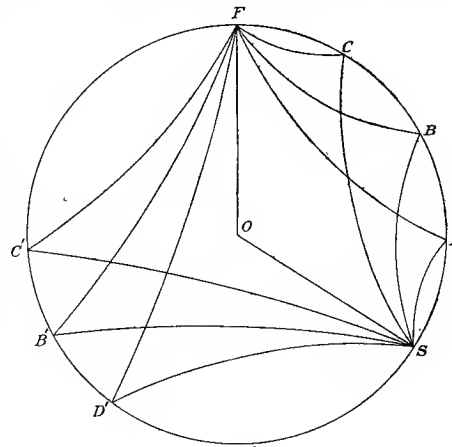

FIG. 29.

¹ The reflection and refraction of waves in elastic media was first thoroly elucidated by Prof. C. G. Knott, "Earthquakes and Earthquake Sounds," Trans. Seismol. Soc. Japan, 1888, vol. XII, pp. 115-136; "Reflection and Refraction of Elastic Waves, with Seismological Applications," Phil. Mag., 1899, vol. XLVIII, pp. 64-97, 567-569. He has also given a very interesting account of the subject in his recently published work, "The Physics of Earthquake Phenomena." Prof. E. Wiechert has also discuss this subject ("Ueber Erdbebenwellen," Nach. d. K. Gesells. d. Wissen. zu Göttingen, Math.-phys. Kl., 1907).

without change of type, and the reflected waves will reach S ; similarly the distance may be divided up into any number of equal lengths, and waves can be reflected successively at all these points without change of type, and reach S . It would be very complicated to follow the course of waves of changing type, but the times of arrival at S of waves of unchanging type can easily be found. The interval for a singly reflected wave would be twice the interval required to go half the distance, and this interval can immediately be taken from the hodograph. The interval for a wave which has suffered two reflections will be three times the interval required to go one-third the distance, and so on. These reflected waves are probably the most important cause of the variations of intensity during the early phases. The first preliminary tremors are always weak, but the addition of the waves after one reflection to the direct waves may make the latter evident, when without them they would not be. This seems the case at Cairo, Batavia, and the Cape of Good Hope. The times of beginning at these observatories, as given by their directors, are within a half minute of the times at which longitudinal waves would reach them after one reflection.

At the following stations the effects of the longitudinal waves after one reflection can be detected at an interval after the beginning which is given in minutes, these being the proper intervals as determined from the hodograph: Tacubaya, 0.5 minute; stations in Great Britain, 2.5 to 3 minutes; Upsala, slight, 2.5 minutes; Jena, 3 minutes; Munich, slight, 3 minutes; Göttingen, due in 2.5 minutes; slight effect in 3 minutes. The smallness of the effects in all these cases, and the fact that the waves are weakened on reflection by having a portion of their energy transformed into waves of the other type, make it improbable that the effect of longitudinal waves after two or more reflections is at all noticeable at very distant stations.

Horizontal transverse vibrations would suffer no transformation, and as they would practically lose no energy by refraction into the air, their amplitudes would diminish much more slowly than those of the longitudinal waves; they should tend, therefore, to cause marked variations in the intensity of the seismogram, the vibrations being transverse to the direction of propagation. Vertical transverse vibrations would suffer transformation like longitudinal waves, provided the angle of incidence were sufficiently small; if, however, the sine of the angle of incidence becomes greater than two-thirds the ratio of the velocities of the transverse to the longitudinal waves, that is, if the angle becomes greater than about 42° , there will be no transformation, and the transverse waves will be totally reflected as transverse waves. It is quite clear, therefore, that they will preserve their intensity far better than the longitudinal waves, and indeed will get energy from the latter.

When we look for the reflected second preliminary tremors on the seismogram, we are disappointed that they are not more marked, but nevertheless evidences of them can be found on many seismograms. For instance, at Tacubaya the waves reflected once and twice coalesce and appear about one minute after the beginning of the second preliminary tremors; the waves reflected once arrive at stations in Great Britain and in Japan from 4 to 5 minutes after the second preliminary tremors, and those reflected twice in about 6 or 7 minutes; the latter are not evident on the Japanese seismograms. At Bombay the two waves reflected once and twice appear after 9 and 13 minutes; at Batavia they are due after 8.5 and 13 minutes; indications of them are found after 8.5 and between 11.5 and 14 minutes; and many other stations could be cited. It is not entirely beyond question that the strengthenings of the seismograms are due to the reflected waves, both in the case of the first preliminary tremors and the second preliminary tremors; but they occur at the times indicated by the hodograph, and it seems most probable that we have interpreted them correctly.

There is one group of reflected transverse waves which have especial interest, namely, those whose angle of incidence is so large that they experience innumerable reflections, that is, they practically creep around the earth's surface. Professor Knott has suggested that they are the so-called surface waves.¹ But there are certain obvious objections to this idea. They are, that the speed of propagation could not be less than the speed of the transverse waves near the surface of the earth; this speed appears to be about 4.8 km./sec., considerably greater than that of the long waves; again, the energy in the surface waves is much greater than in the second preliminary tremors, but possibly the distribution of energy on account of the change of velocity, with the depth below the surface and the retention of energy by the transverse waves creeping along under the surface, may account for this; lastly, observations do not show consistently that the surface waves are made up in large proportion of transverse waves (see page 114). But, nevertheless, Professor Knott's suggestion is a very interesting one, and it is quite possible that these objections may be overcome when we have more accurate knowledge of the various quantities concerned.

It is difficult to find the time of arrival of waves reflected once in the major arc. The minor arc must be greater than 120° for half the major arc to be less than this value, which is the limit to which the hodograph can be relied upon. The first preliminary tremors, after reflection in the major arc, are apparently too weak to be evident on the seismogram. It would take about 55 minutes for the transverse waves, reflected once on the major arc, to reach stations beyond 120° from the origin; that is, they would reach them at about $14^h 07^m$; at Bombay the motion becomes most irregular at this time; at Batavia there are variations of intensity, but nothing very definite; at Kodaikanal and at Perth the seismograms are stronger at about this time. Altho we can not give the exact time at which reflections on the major arc would reach stations at a less distance than 120° from the origin, the hodographs show that they could not possibly be earlier than the arrival of the regular waves, and, therefore, they are completely masked by the much stronger disturbance existing during the regular waves, the principal part, and the earlier parts of the tail.

THE SURFACE WAVES.

In addition to the times of arrival of the first two phases we have plotted in plate 2 the times of arrival of the regular waves. The surface waves are spread over many minutes on the seismogram, but as already noted, we have taken as the beginning of the regular waves that point where the irregular movement (which is a part of, or follows, the second preliminary tremors) becomes regular, with a long period (30 to 50 seconds). The plotted positions of these times of arrival lie very closely along a straight line and no other simple curve could be drawn which would fit the observations materially better. To determine the best straight line to use we resort to the method of least squares, but as the observations differ very much in their reliability, each one is given a suitable weight. No elaborate distribution of the weights has been made. The observations which are considered good have received the weight 5, those which are fair 3, and those which are doubtful 1; a few observations which are very doubtful have been left out altogether. Where several stations have been grouped together the weight of the average is, of course, the sum of the weights of the individual stations. Those observations are considered doubtful which, on account of the absence of the seismogram, could not be checked, or in which the seismogram does not show clearly just where the regular waves begin. In table 14 we have collected the observations which have been used in determining the straight hodograph of the regular waves and their weights.

¹ The Physics of Earthquake Phenomena, p. 256.

TABLE 14.—*Time Intervals and Weights of Observations for determining the Hodograph of the Regular Waves.*

STATION.	DISTANCE.	TIME INTERVAL.	WEIGHT.	STATION.	DISTANCE.	TIME INTERVAL.	WEIGHT.	
	°	<i>min.</i>			°	<i>min.</i>		
1. Sitka	20.72	10.07	1	13. {	86.01	41.83	25	
2. Tacubaya	27.70	13.15	3					Tortosa
3. Toronto	32.93	15.40	3					Krakau
4. { Washington }	35.54	17.33	10	Pavia	88.16	40.95	5	
Cheltenham }				Vienna				
5. Trinidad	60.94	29.50	1	Laibach	90.48	45.03	1	
6. { Paisley }	72.76	35.20	10	Zagreb				
Edinburgh }				14. {	88.16	40.95	Pola	
7. { Bidston }	74.37	34.78	6	Quarto-Cas- tello			91.84	43.93
Upsala				Zi-ka-wei				
8. { Shide }	77.27	37.37	25	15. Rocca di Papa	92.63	44.30	3	
Osaka				16. Ischia	93.58	44.63	1	
Kobe				17. Caggiano	95.04	43.93	3	
9. { Hamburg }	80.28	39.03	6	18. Sofia	97.62	49.70	1	
Irkutsk				19. Catania	98.28	49.63	1	
10. { Potsdam }	81.37	38.65	15	20. Wellington	100.43	48.50	2	
Göttingen }				21. Calamate				
Coimbra	82.43	38.80	10	22. { Christchurch }	112.72	53.10	1	
Leipzig				Manila				
11. { Jena }	84.75	39.25	5	23. Calcutta	121.19	59.30	3	
Munich				24. Bombay	124.99	61.90	5	
				25. Batavia	132.37	65.80	5	
				26. Perth	148.63	81.00	1	
				27. Cape of Good Hope				

The observations used come from 47 stations, but they are only represented on the plate by 27 points, on account of the grouping together of stations at very nearly the same distance from the origin. The hodograph is determined from nearly twice as many stations as would be inferred from a cursory glance at the plate. We can not assume that the straight hodograph, determined from these observations, passes thru the origin; but we seek the position of a straight line in general which will best fit the observations.

The general equation of a straight line is $y = mx + b$. In this case y is the time of arrival of the long waves, x the distance of the station from the origin in degrees, m the reciprocal of the velocity of transmission, and b the point where the line cuts the axis of y ; $-b/m$ is the point where it cuts the axis of x . On working out, by the method of least squares, the most probable values for m and b according to the weighted observations, we find

$$m = 0.494 \text{ min./deg.} \quad b = -0.91 \text{ min.} \quad 1/m = 2.03 \text{ deg./min.}$$

The velocity of the regular waves $1/m$ is equal to 2.03 deg./min., or 3.75 km./sec.; and the point where the line crosses the axis of x is given by $-b/m$, which equals 1.84° or 205 km. These are the most probable values of the quantities concerned as deduced from the observations, but they are the result of a very limited number of observations and might be modified by results obtained in other earthquakes; and therefore we can not suppose that the constants are very accurately determined. On the other hand, the observations are in fair agreement with each other and therefore the results can not be very far wrong.

The fact that the straight line does not pass thru the origin, but crosses the axis of x at a distance of 205 km. from the origin does not mean that the regular waves start at this point at the time of the shock. Indeed, we have no observations at all along this part of the line, but there is a very simple explanation of the fact that the line does not pass thru the origin. This is that the regular waves are generated by one of the first two phases at the surface of the earth at a short distance from the origin. The point and

time at which the waves are brought into existence would be one of the two points where the hodograph of the regular waves crosses the hodographs of the first two phases. If the regular waves are started by the first preliminary tremors, this point would be at a distance of 3.88° or 431 km. from the origin; and the waves would begin there 1 minute after the shock occurred. If they were started by the second preliminary tremors they would originate at a distance of 8.41° or 935 km. from the origin and 3.25 minutes after the occurrence of the shock. It seems probable that the surface waves are due in a greater degree to the transverse than to the longitudinal waves, on account of their greater amplitude. As pointed out by Lord Rayleigh, the surface waves expand along the surface in two dimensions, whereas the other waves expand thru the body of the earth in three dimensions; the former, therefore, decrease in amplitude much more slowly than the latter and at distant stations cause a greater movement than the preliminary tremors which started them.

This would account for the preponderance of transverse motion in the principal part of the recorded disturbance, which has been observed in some cases. We must not infer, however, that there are no surface waves nearer the origin than the points we have designated; on the contrary, it is extremely probable that surface waves will be started at all parts of the surface within these distances when the earlier phases arrive there; but as the latter travel more rapidly than the former, new surface waves will be originated in front of them and will always lead them in their passage around the world. It seems probable that the regular waves are the leaders of the surface waves; hence their importance. If there are others which precede them, they are very irregular and their beginning does not produce a sufficiently definite point on the seismogram to be generally recognizable.

The straightness of the hodograph of the regular waves shows that the velocity of propagation is uniform along the arc, and therefore it is practically certain that the waves travel along the surface of the earth and we can apply our equation to determine the time of arrival at any point on the surface when we know its distance from the origin. We thus find 88 minutes as the time necessary to travel 180° to the antipodes.

PROPAGATION ALONG THE MAJOR ARC.

We could find, from the equation, the time necessary to reach any station by the major arc. This would apply only to the regular waves, but other surface waves, moving with smaller velocities, would take longer times to reach the station. Waves of so many velocities occur that we can not work out the hodographs of them all; and we do not know at what points they start, but it is probable, as in the case of the regular waves, that they start very near the origin and that their velocity will be given with a sufficient approximation by dividing the distance of the station by the time interval of their arrival after the occurrence of the shock. With this method it is very easy to find the time interval of the arrival of waves having the same velocity by the major arc. Let T represent this interval and t the interval by the minor arc; let d be the distance in degrees by the minor arc; then we find, very simply,

$$T = t \frac{360^\circ - d}{d} \quad \frac{(T - t)}{2} = \frac{t(180^\circ - d)}{d}$$

These expressions do not contain the velocity explicitly, and apply to surface waves having any constant velocity. The quantities $\frac{360 - d}{d}$ and $\frac{180 - d}{d}$ are constant for each station; and we merely have to multiply the first by t , the time interval of the surface waves by the minor arc, to obtain the interval after which the corresponding waves would arrive

by the major arc; or we may find the interval between the arrivals of the waves by the two routes by multiplying the second quantity by $2t$. This process can be carried out graphically with ease for seismograms having a small time scale, such as those of Milne pendulums. Mark on the seismogram (fig. 30) the point o , the moment when the earthquake occurred at the focus; at any point, as for instance p' , erect a perpendicular $p'e'$, equal in length to $op' \frac{180^\circ - d}{d}$; draw a straight line oe' , and produce it; the height pe of this line above any point p of the seismogram will represent half the interval after p , before the arrival of the surface waves by the major arc, corresponding to those which, following the minor arc, are recorded at p . If we cut from a sheet of paper

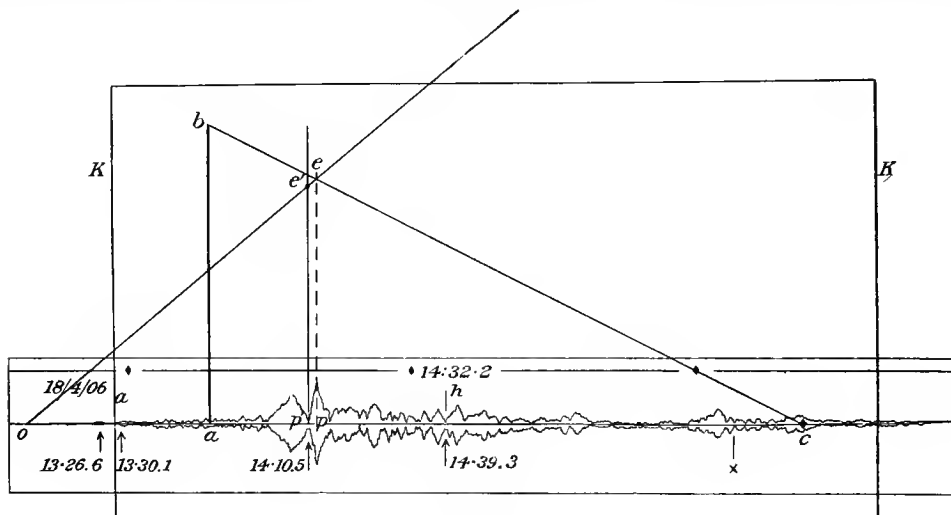

FIG. 30.

KK , a triangle abc , such that ac equals $2ab$, and place the triangle so that ac lies along the medial line of the seismogram, the point c will mark the place where the major arc waves, corresponding to the minor arc waves recorded immediately under the point where bc cuts oe' , will be recorded; by this device the whole seismogram can be examined in a few minutes. This method must be modified to apply to seismograms with open time scales, and it then requires a very large space; it is simpler, with such seismograms, to calculate T directly, with a slide-rule, from the first expression given above. When we apply this graphical method to the Milne seismograms we find, in the majority of cases, that there are marked swellings on the seismogram at the time the waves of the strong motion would arrive by the major arc. The seismograms of instruments with open time scales yield much less definite results; indeed, in the majority there is no sufficiently well-marked increase in amplitude to make one certain that the major arc waves have produced any sensible effect.

The seismograms yield various results, as follows:

Honolulu. — The swellings from $16^{\text{h}} 00^{\text{m}}$ to $16^{\text{h}} 18^{\text{m}}$ mark waves arriving by the major arc corresponding to the strongest motion of the direct minor arc waves. If the strong motion recorded at $14^{\text{h}} 30^{\text{m}}$ is due to surface waves, the corresponding major arc waves would appear at 24^{h} , long after the record was over. A small disturbance lasting for an hour is reported about 45 minutes after this time. If the movement mentioned is really due to surface waves arriving by the minor arc, their velocity of propagation would be about 1 km./sec., which is so extremely slow that we are led to discard this explanation of its origin.

San Fernando. — The strong group at 15^h 43^m is due to major arc waves corresponding to the strongest part of the motion.

Kew. — Major arc waves arrive at 16^h 08^m. Upsala and Kobe show nothing.

Paisley. — Major arc waves would be expected at 16^h 05^m. There are many beads in this part of the seismogram, but none especially strong. The very strong swelling, 16^h 13^m to 16^h 22^m, corresponds to minor arc waves arriving 4 minutes after the end of the strongest motion.

Edinburgh. — Major arc waves at 16^h 08^m and 16^h 11^m.

Bidston. — Major arc waves from 15^h 40^m to 16^h 00^m; but the earlier and equally strong beads would correspond to much smaller direct waves.

Tokyo. — Professor Omori places the arrival of the major arc waves at *f*, 15^h 31^m. They would correspond to the direct waves arriving at 13^h 48.5^m.

Coimbra. — Major arc waves arrive at 15^h 40^m. The swelling at 15^h 21^m corresponds to the beginning of the long waves which are apparently not so strong. There is a slight increase in intensity at Göttingen at 15^h 40^m and 15^h 48^m. The latter is also apparent at Coimbra. There is no evidence of major arc waves at Jena.

Irkutsk. — The major arc waves would be expected at a point on the seismogram opposite the last hour mark, but nothing appears.

Vienna. — Major arc waves are due at 15^h 32.5^m, but the seismogram at this point does not differ from the previous part of the record.

Wellington. — The large swellings before *x* and after *e'* are the major arc waves corresponding to the two large swellings on each side of *e*, but the major arc waves due to the large movement at 14^h 25^m are not evident.

Bombay. — Major arc waves should appear at the gap in the seismogram. The strong swelling at 15^h 10^m corresponds to the beginning of the long waves, but it is so much stronger than the record of the direct waves that we can not correlate them.

Batavia. — Nothing definite appears at 15^h 14.5^m and 15^h 39^m, when the major arc waves would be expected.

Perth. — There are so many swellings that it is not possible to identify positively the major arc waves. The large swelling at 15^h 05.5^m corresponds to the beginning of the long waves at 14^h 18.3^m, but it is so much stronger than the direct waves that we can not consider it related to them.

If we attempt to find the major arc waves corresponding to the direct waves which produce the largest earth-amplitudes, as they are given in table 19, page 138, we find the evidence of their existence entirely negative. The times of arrival of the direct waves and the major arc waves at several stations are contained in the following table:

TABLE 15.—*Times of Arrival of Corresponding Minor and Major Arc Waves.*

STATION.	MINOR ARC WAVES.		MAJOR ARC WAVES.	
	<i>m.</i>	<i>s.</i>	<i>m.</i>	<i>s.</i>
Upsala	13	51	15	36
Göttingen	13	53.5	15	38
Leipzig	13	55.5	15	37.5
Jena				
Vienna	13	59	15	59.5
Batavia	14	17.5	15	14.5
	14	36.5	15	39

There are three stations situated practically on the same great circle passing thru the origin: Coimbra (81.4°), San Fernando (85.3°), and Wellington (262.4°), and they all have Milne pendulums. The major arc waves which arrive at Wellington at 15^h 36^m cause the latter part of the strong motion at Coimbra at 13^h 57^m. They should appear at

San Fernando at 13^h 59^m, and probably are indicated by the strong motion a minute earlier; the major arc waves arriving at Wellington at 15^h 52^m appear at Coimbra at 14^h 01^m, and cause the strong motion at San Fernando at 14^h 04^m. The direct waves at Wellington at 14^h 07^m and 14^h 12.5^m are due at San Fernando at 15^h 41^m and 15^h 50^m and are undoubtedly represented by the strong swelling about 15^h 43^m; they are due at Coimbra at 15^h 43^m and 15^h 53^m; these are weak parts of the curve, but probably the swellings a few minutes earlier than these times represent the waves we are considering.

We must conclude, from the foregoing survey, that altho the strong motion arriving by the major arc makes itself evident at some stations, perhaps on account of synchronism of its period and that of the recording instrument, at other stations it can not be detected. The small time scale of the Milne seismograms is much better adapted for identifying the major arc waves than the open time scale of other instruments.

EQUALITY OF VELOCITIES ALONG DIFFERENT PATHS.

As already pointed out, all the distant stations had instruments of low magnifying power and apparently were too late by various amounts in recording the shock; so we must confine our attention to stations less than 100° distant. On comparing the times of arrival of the various phases (given in table 7, page 116) at stations nearly equally distant, we can not find any differences, greater than the errors of observation, which might be dependent upon the direction of the station from the origin; and this applies to all three phases of the motion. Thus, Honolulu receives the second preliminary tremors a little earlier than the observations at stations in the east of North America would lead us to expect (see hodograph, plate 2), but the first preliminary tremors arrive at the expected time. The paths to Honolulu and these stations are totally different, the first being under the Pacific and the other across the continent of North America, as shown in plate 1.

The Japanese, on the one hand, and the British and Scandinavian stations, on the other, are about equally distant from the origin; the path to the former lies under the deep Pacific, that to the latter across North America, Greenland, and under the shallow North Sea; but we do not find a greater difference between the times of arrival at these two groups of stations than we do between the individual stations of the same group.

Irkutsk and Jurjew are at practically the same distance from the origin; the path to Irkutsk passes under the Pacific, across Alaska and northeastern Asia; the path to Jurjew crosses North America and Greenland and continues under the North Sea; yet the times of arrival at the two stations are within a very few seconds of each other.

We conclude, therefore, that the velocity of propagation is independent of the position of the projection of the path on the earth's surface; or, at least, is too little affected by it to be detected by our observations.

COMPARISON OF THE HODOGRAPHS OF THE CALIFORNIA EARTHQUAKE WITH OTHER OBSERVATIONS.

When we compare the hodographs obtained from the California earthquake with those given by Professor Milne in 1902¹ and with those of Professor Oldham, 1900,² we find that our times of arrival of the first and second preliminary tremors are, for the greater part of the curves, about 2 minutes earlier. This appears to be due to lack of accuracy in the earlier observations, and a glance at the earlier diagrams will show that the curves are drawn from observations differing greatly among themselves.

¹ Report Seis. Com. B. A. A. S., 1902.

² On the Propagation of Earthquake Motion to Great Distances. *Phil. Trans. R. S.*, 1900-1901, vol. 194, pp. 135-174.

The hodograph of the "large waves" of Professor Milne in the earlier observations does not refer to the same surface waves as those which are here tabulated as *regular waves*, but to the time of maximum displacements on the seismograms. The position of the maximum is very largely dependent upon the proper period of the recording pendulum, and the instruments whose records we have of the California earthquake differed so greatly in this respect that it is not possible to identify as a maximum any characteristic part of the disturbance, except for a limited number of seismograms.

In his very interesting memoirs on the propagation of earthquake motion, Prof. G. B. Rizzo gives hodographs of the two Calabrian earthquakes of September 8, 1905, and October 23, 1907. The former was a severe earthquake and was recorded all over the world. The latter was much smaller and satisfactory observations were only obtained up to distances of about 22° . The hodographs of the first and second preliminary tremors agree very well with my curves, except about 20° and in the immediate neighborhood of the origin, where Professor Rizzo has made his curve convex upward to represent the assumed changes in surface velocity; and he has measured his times from the estimated time of arrival of the disturbance at the epicenter, whereas I have measured time from the actual time of occurrence of the shock at the focus, and have assumed the velocity of 7.2 km. per second for short distances from it.

Professor Omori, in his very complete account of the seismograph records of the Kangra earthquake of April 4, 1905,¹ gives the hodographs of the first and second preliminary tremors and a later phase of the principal part; the latter, however, does not correspond to the regular waves which I have recorded. The hodographs of the first two phases correspond fairly well with those of the California earthquake² up to distances of about 60° for the first preliminary tremors and 90° for the second preliminary tremors; but beyond they diverge greatly. It is rather curious that the observations of the Indian earthquake are most numerous between 37° and 60° , in which interval there is but one observation of the California earthquake; whereas, between 70° and 100° , where the great majority of the observations of the California earthquake lie, there are but four very unsatisfactory observations of the Indian earthquake. The cause of the disagreement between the observations at the greater distances is very evident. All the observations of the Indian earthquakes at distances greater than 60° are made with instruments of very low magnifying power, and it is hardly possible that the true beginning of the disturbance has been recorded. With regard to the second preliminary tremors it is a question of the interpretation of the seismograms. Of the four observations which Professor Omori uses beyond 90° three are from Bosch-Omori 10 kg. instruments, and I think it quite impossible from an examination of their seismograms to determine where the second preliminary tremors really began. The other record, at Wellington, was made by a Milne pendulum, and the time I take to mark the arrival of the second preliminary tremors is nearly 10 minutes earlier than that taken by Professor Omori, and is between 2 and 3 minutes later than my curve would lead us to expect. The record at Christchurch, 0.7° nearer the origin, is 2.5 minutes earlier. The Milne seismograms from Victoria, Toronto, Baltimore, and Christchurch (from 97.7° to 115°) are not used by Professor Omori in making his hodograph of the second preliminary tremors, tho he reproduces them among his plates. As I read them, the times of arrival of the second preliminary tremor are in fair agreement with my curves and are from 8 to 12 minutes earlier than the times adopted by Professor Omori for similar distances. He is thus led to nearly linear hodographs of the first and second preliminary tremors, and consequently to a linear relation between the distance of an earthquake origin and the duration of the first preliminary tremors.

¹ Report on the Great Indian Earthquake of 1905. Pub. Earthquake Investigation Committee in Foreign Languages, Nos. 23 and 24.

² Professor Omori also gives the velocities obtained from the California earthquake in the same report, but he has taken the time of the shock a half minute too early.

TABLE 16.—*Transmission Intervals (in minutes) for Three Earthquakes.*

DISTANCE.	FIRST PRELIMINARY TREMORS.				SECOND PRELIMINARY TREMORS.			
	Indian.	Calabrian.	California.	Average.	Indian.	Calabrian.	California.	Average.
0	<i>min.</i>	<i>min.</i>	<i>min.</i>	<i>min.</i>	<i>min.</i>	<i>min.</i>	<i>min.</i>	<i>min.</i>
10	2.6	2.24 ¹	2.4	2.41	4.6	4.06	3.85	4.17
20	4.5	4.26 ¹	4.3	4.35	8.4	8.05	7.6	8.02
30	6.2	6.12	6.1	6.14	11.3	11.26	10.9	11.15
40	7.6	7.35	7.7	7.55	13.9	13.80	13.8	13.83
50	9.0	8.51	9.0	8.84	16.2	16.24	16.3	16.25
60	10.6	9.67	10.2	18.9	18.68	18.6	18.73
70	12.2	10.78	11.35	20.7	21.12	20.6	20.81
80	13.9	11.89	12.3	24.7	23.57	22.25
90	15.7	13.00	13.25	27.5	26.00	24.0
100	17.3	14.11	14.2	30.4	28.56	25.6

In table 16 have been collected the transmission intervals in minutes for the first and second preliminary tremors of the Indian earthquake of April 4, 1905, the Calabrian earthquake of September 8, 1905, and the California earthquake of April 18, 1906. The data for the Indian earthquake are taken from plates III and IV of Professor Omori's report, that of the Calabrian earthquake from table 2 of Professor Rizzo's first memoir,¹ and that of the California earthquake from table 11, page 120 of this report. A very close agreement exists up to 50° for the first preliminary tremors and up to 70° for the second preliminary tremors, with the exception of the interval at 20°, and we may accept the averages given as representing to a very fair degree of accuracy the time intervals necessary to travel the corresponding distances. The four intervals marked are from Professor Rizzo's second memoir² and refer to the Calabrian earthquake of October 23, 1907; they are a little shorter, and I think a little more accurate, than the corresponding intervals for the earlier earthquake.

DETERMINATION OF THE DISTANCE OF THE ORIGIN OF AN EARTHQUAKE.

Professor Milne in 1898³ showed that the distance of an earthquake from the recording station could be determined by the interval of time between the beginning of the disturbance and the arrival of the large waves, and he drew a preliminary curve to represent this relation. In 1902⁴ he gave more accurate results based on more abundant data. Professor Omori has followed up this subject and has drawn curves and given equations to determine the distance of the origin from the duration of the first preliminary tremors and from the interval between the first preliminary tremors and the long waves.⁵ His relations are linear, one equation being given for near origins and a second for distant origins.

In fig. 31 curves are drawn which are taken directly from the hodographs in plate 2 and show the interval elapsing between the first and second preliminary tremors, between the first preliminary tremors and regular waves, and between the second preliminary tremors and regular waves. These three curves are of course not independent; any one of them could be deduced directly from the other two. By means of them a typical seismogram will give two independent determinations of the distance of an earthquake origin. These

¹ Nuovo Contributo allo Studio della Propagazione dei Movimenti Sismici, Acad. R. d. Scienze di Torino, 1907-1908, vol. LIX, p. 415.

² Sulla Velocità di Propagazione della Onde Sismiche, Acad. R. d. Scienze di Torino, 1905-1906, vol. LXVII.

³ Report Seis. Com. B. A. A. S., 1898.

⁴ Same, 1902.

⁵ Pub. Earthquake Investigation Commission in Foreign Languages, Nos. 5 and 13, Bull. Imperial Earthquake Investigation Commission, vol. II, pp. 144-147. Also Report on the Great Indian Earthquake of 1905. Publications, etc., No. 24, pp. 179-186.

curves have a certain advantage over most similar curves heretofore given because the time and origin of the California earthquake are known to a higher degree of accuracy and because more and better instruments have recorded this shock than were in use in earlier times. Nevertheless, they are free-hand curves, and the observations not perfectly concordant, both of which facts reduce their accuracy. Moreover, the duration of the first preliminary tremors increases very slowly with the distance from the origin, which makes the determination of the distance by means of the interval rather inaccurate. It will be seen that the lines are not straight, altho their curvatures are not very great. The interval between the first and second preliminary tremors are given from the origin, because both these phases apparently begin there, but the curves dependent upon the regular waves start about 10° from the origin; the first observation we have of the regular waves is at a distance of about 20°; and the parts of the curves nearer the origin are drawn on the supposition that the hodograph of the regular waves continues as a straight line to within 10° or so of the origin.

The time of the occurrence of the shock, and therefore the early part of the hodographs, is based on the assumption that the velocity of the first preliminary tremors is 7.2 km./sec. near the origin, and that of the second preliminary tremors in the same region, 4.8 km./sec. These values fit very well into the general curves of the hodographs; but that would also be true of values differing 10 or 15 per cent from them; but it would hardly be true for values differing more than this.

The duration of the first preliminary tremors does not depend upon these values, but upon the record at Mount Hamilton, where it was 9 seconds.

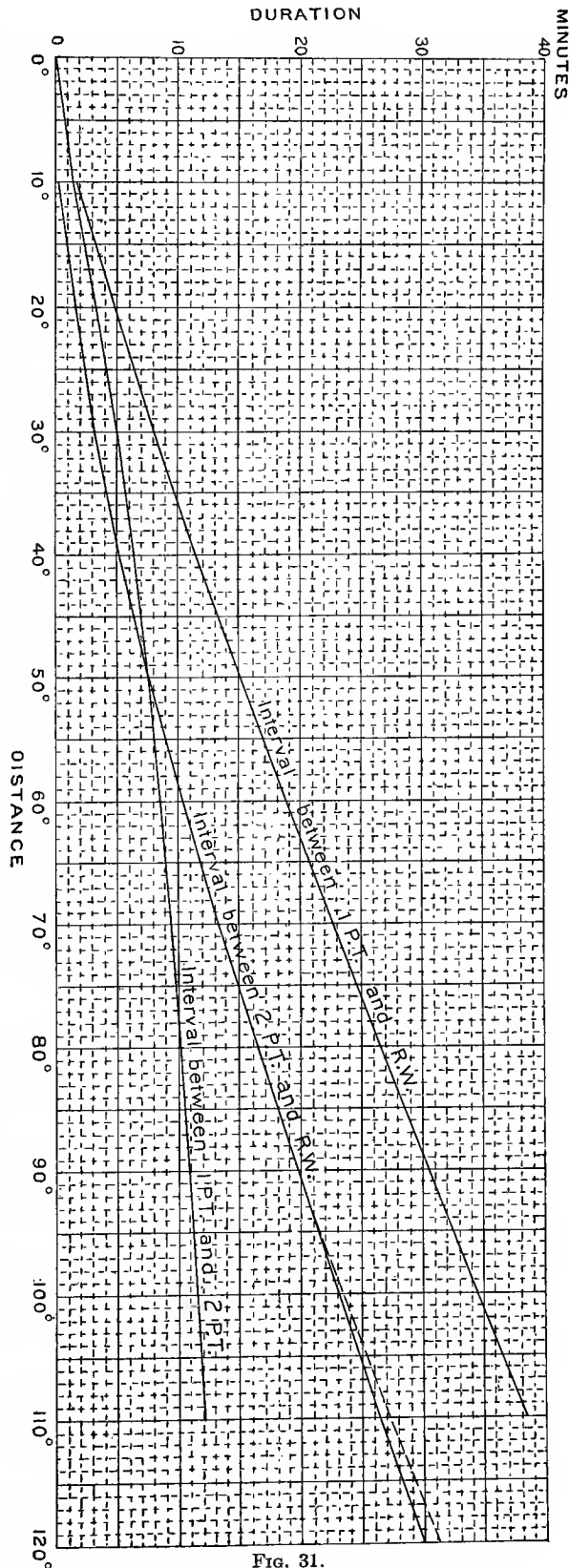

FIG. 31.

Mount Hamilton is about 128 km. from the origin, and if we assume that for distances of a few hundred kilometers the duration of the first preliminary tremors is proportional to the distance which the approximate straightness of the hodographs of the first two phases near the origin indicates, we find the following relation between the distance d and the duration t' of the first preliminary tremor:

$$d \text{ (km.)} = 14.2 t' \text{ (sec.)}.$$

As the position of the origin is not known nearer than 20 km. the number in the second member may lie anywhere between 12 and 16.2.

PERIODS AND AMPLITUDES.

The study of the seismograms reveals the periods of the vibrations in different parts of the disturbance as recorded at a number of stations. The actual amplitude of the earth movement can only be determined by a calculation which depends upon the period of the waves, the period of the pendulum, and the constants of the instruments. The calculation is made in accordance with the formulas, equations 79 or 81, page 169. In many cases the period of the pendulum is the same as that of the vibration and then, if there is not very strong damping, the magnifying power becomes indefinitely large and is undeterminable; this is the condition at many stations where large movements are recorded by the seismographs; but it has been possible, in a number of cases, to determine roughly the true movement of the ground. The amplitudes on the two components at right angles to each other do not always reach their maxima at the same time; it sometimes happens that the movement is alternately strong on one component and the other. This was the case at Porto Rico, Upsala, and Pavia. Even when the maxima occur on the two components at the same time, one does not always get the true amplitude of the earth's motion by taking the square root of the sum of the squares of the two components, for the difference of phase has an influence; but this is the only method we can use, and the quantities given in the column headed "Poss. total" in table 19 were obtained in this way.

DURING THE PRELIMINARY TREMORS.

The vibrations during the first preliminary tremors frequently have periods in the neighborhood of 5 seconds; other periods were also present, but were not so persistent. At Jurjew the period during the first preliminary tremors was 29 to 30 seconds. It seems as tho there were many periods present and that the period which was close to that of the instrument was singled out and made prominent. At Sitka a period of about 17 seconds was shown.

During the second preliminary tremors vibrations of various periods were also present, but those which had the largest amplitude seem to be about 15, 20, and 28 seconds.

TABLE 17. — *Periods and Amplitudes during the Preliminary Tremors.*

STATION.	DISTANCE.		DIRECTION OF APPROACH.	COMPONENT.	FIRST PRELIMINARY TREMORS.		SECOND PRELIMINARY TREMORS.		
					Amplitude.	Period.	Amplitude.	Period.	Time.
	°	km.			mm.	sec.	mm.	sec.	h. m.
Sitka . . .	20.72	2302	N. 27° W.	North . .	0.48	17	0.215 ?	15
Ottawa . .	35.37	3930	N. 85° W.	{ North . .	0.004	6.7 ¹
				{ East . .	0.005	6 ¹
Washington .	35.44	3937	N. 75° W.	North	0.21	28	13 26
Upsala . .	76.80	8533	N. 29° W.	North . .	0.0013	4	0.37	19	13 44
Osaka . . .	77.30	8589	N. 55° E.	East . . .	0.01	5
Jurjew . . .	80.27	8918	29-30
Potsdam . .	81.35	9039	N. 37° W.	{ North	5	0.17	23	13 36
				{ East	0.12	27	13 45
Irkutsk . .	80.82	37, 50
Göttingen .	81.36	9040	N. 39° W.	{ East	1, 2, 5	0.041	16	13 36
				{ Vertical	5, 8
Leipzig . .	82.40	9155	N. 38° W.	North . .	0.0024	5, 9	0.028	20	13 36
Jena . . .	82.45	9161	N. 39° W.	{ East . .	0.0018	4, 8
				{ North . .	0.0052	4, 10	0.11	19	13 36
Munich . .	84.75	9417	N. 39° W.	{ North . .	0.0023	5	0.0155	20
				{ East . .	0.0023	5	0.0034	15	13 36
Vienna . .	86.37	9596	N. 37° W.	{ North . .	0.022	5
				{ East . .	0.018	5
Batavia . .	124.99	13887	N. 50° E.	North . .	0.0056	5, 8, 10	0.006 ?	10

* Uncertain on account of closeness of periods.

The amplitudes recorded are very small and are not very regular. The nearest point where a determination could be made for the first preliminary tremors was Sitka, and there the earth-amplitude was just under 0.5 mm. At Ottawa it had already diminished very greatly, being about one-hundredth as much for both components. These values are somewhat uncertain, as the periods were very near those of the pendulums. Table 17 shows the amplitudes at a number of stations; in general they lie between 0.002 mm. and 0.02 mm. The reason for the absence of a progressive diminution is not at all clear. It does not seem to be sufficiently accounted for by differences in the foundation. It is possible that the discordance may be largely due to inaccuracy in the constants of the instruments, especially the omission of the solid friction, and also, possibly, to the application of the formula to parts of the record where the movement has not been sufficiently regular for the formula to apply accurately.

During the second preliminary tremors there is a very large increase in the amplitude, to about 10 times that of the first preliminary tremors; we find the same kind of irregularity in the amplitudes at successive stations but we do not find the proportion between the amplitudes of the first and second preliminary tremors constant; at Leipzig, the amplitude of the second preliminary tremors was 10 times that of the first preliminary tremors, whereas at Jena it was 20 times as great. This probably indicates a lack of accuracy in the determination of earth-amplitudes.

DURING THE REGULAR WAVES AND THE PRINCIPAL PART.

In the megaseismic district. — The temporary nature of the vibrations makes it impossible to get satisfactory measures of the amplitudes, unless a permanent record of some kind is made. There are, fortunately, a few such records which enable us to form a rough conception of the amount of the movement.

Professor Omori, guided apparently by the damage done, estimates that, on the filled-up grounds of San Francisco, the amplitude of the vibration was 50 mm. (2 inches), and the period 1 second.¹ The distance from the fault was about 14 km.

On the rock at Berkeley Observatory (distant 30 km.) the vertical component of the amplitude was 23 mm. (1 inch), and the horizontal component, according to the Ewing duplex pendulum, more than 11 mm.

At Mare Island (distant 40 km.) Professor See estimated the horizontal amplitude in the soft made ground at 50 to 75 mm. from the displacement of loose dirt about piles which supported buildings (vol. I, p. 212).

At a number of stations in the megaseismic district, given in table 18, which were provided with simple instruments, the amplitude of the movement was greater than the instruments could record, that is, in general, was greater than 10 mm.; and it is probable that it was several times greater.

TABLE 18. — *Amplitudes in the Megaseismic District.*

STATION.	DISTANCE FROM FAULT.	COMPONENT.	DISPLACEMENT.
	<i>km.</i>		<i>mm.</i>
Los Gatos	6	Horizontal	5+
San Francisco	14	Horizontal	50
San Jose	18	Horizontal	10+
Oakland	24	Horizontal	10+
Alameda	29	Horizontal	10+
Berkeley	30	{ Vertical	23
		{ Horizontal	11+
Mount Hamilton	35	{ North-south	40+
		{ East-west	40+
Mare Island	40	Horizontal	50 to 75
Carson City	291	Horizontal	11

¹ Bull. Imperial Earthquake Investigation Commission, vol. 1, p. 19.

At Mount Hamilton (1.16° or 129 km. from the origin and 35 km. from the fault) the 3 component Ewing instrument indicated amplitudes, both in the north-south and east-west directions, greater than 40 mm.

At Carson City (2.62° or 291 km.) the horizontal amplitude was about 11 mm. in all directions.

Beyond the megaseismic district.— We have collected in table 19 the periods and the greatest earth-amplitudes at all the stations for which we have sufficient data to determine these quantities. In a few cases they are taken directly from published reports. At many stations there was so close a correspondence between the period of the vibrations and that of the pendulum during the very strong motion that it was impossible to make any determination of the earth-amplitude.

It will be seen that the periods of vibration during the regular waves were, in general, not very far from 30 seconds, tho in a few cases they were 10 or 12 seconds less, and in a few 10 or 20 seconds more. During the principal part the periods were principally between 17 and 25 seconds.

Where we have determinations of the earth-amplitude during both the regular waves and principal part at the same station, the former seems to be somewhat the larger, altho the instrumental record on the seismogram is almost always larger during the principal part. This is due to the variations in the magnifying power of the instrument on account of difference in periods.

Altho the amplitudes do not diminish regularly with the distance from the origin, nevertheless with the exception of a few abnormal values, which are not understood, there is in general a reduction of amplitude with the distance. In the megaseismic region we found that these amplitudes were 50 mm. or more; at distances of 30° to 50° they have diminished to about 5 mm., and we must go as far as 100° or so to find amplitudes less than 1 mm. We see, therefore, that the great world-shaking earthquakes cause movements of the earth at great distances which are by no means inconsiderable, and the only reason why they are not felt is that the period is very long, and, therefore, the movement too slow to make them evident to our senses.

In attempting to determine the depth of the fault (page 13) we were led to assume that the energy is sent out from the fault-plane proportionally to the cosine of the angle between the direction of propagation and the normal. Altho this will probably hold approximately in the neighborhood of the fault, it does not hold at a distance, where the distribution of the energy, so far as we can tell from the altogether unsatisfactory determinations that could be made, is entirely independent of the direction from the origin. For instance, Sitka and Tacubaya, whose directions make angles 16° and 29° , respectively, with the direction of the fault, have apparently instrumental amplitudes similar to those of the stations in the eastern part of North America, whose direction is nearly at right angles to the fault-plane. Pilar, Argentina, and the Cape of Good Hope, whose directions make angles of 12° and 51° with the fault, gave very small records, whereas Mauritius (nearly 35°) gave a much larger record. Calcutta, Kodaikanal, and Bombay (5° to 16°) also gave much larger records.

In looking over the table of earth-amplitudes, to compare the results between stations at about the same distances from the origin, but in different directions, we find the irregularities so great that no satisfactory conclusions can be drawn. We notice, however, that Zi-ka-wei had about the same amplitude during the principal part as Carloforte and Sarajevo; and that the amplitudes at Sofia, Catania, and Manila do not differ greatly during the regular waves; but these comparisons carry very little conviction with them, because of the great variations between the amplitudes at various European stations, which do not differ greatly in their distances from the focus nor in their directions from it.

TABLE 19.— *Periods and Amplitudes during the Regular Waves and the Principal Part.*

STATION.	DIS-TANCE.	COMPONENT.	REGULAR WAVES.				PRINCIPAL PART.						
			Ampli-tude.	Poss. total.	Period.	Time.	Ampli-tude.	Poss. total.	Period.	Time.			
	°		mm.	mm.	sec.	h.	m.	mm.	mm.	sec.	h.	m.	
Cheltenham .	35.64	North	2.3+					2.3+	5	13	13	34	
		East	3.2+					3.2+		9	13	36	
Upsala . . .	76.80	North	3.6	} 5.2	33	13	50-52	16, 24	
		East	3.76		50	13	51
Potsdam . . .	81.35	North ¹	} 4	1.7	23.2	13	56	
		North ²	3.65		41	13	53	2.7	28	13	56
		East ²	2.2	22	13	56
Göttingen . .	81.36	North ³	0.8+	} 1.6+	30	} 13	52-55	1.5	} 0.7+	20	} 13	59	
		North ⁴	0.97+		30			0.52+		20			
		East ⁴	1.31+		30			0.52+		20			
		Vertical	1.64		49			0.7		14.5			
Leipzig . . .	82.40	North	} 2.2	0.58	} 1.65	
		East	1.81		34.5	13	55.7	1.55		13	57.5	
Jena	82.45	North	2.6	} 3.2	30	13	54-56	2.0+	20	
		East	1.9		30	1.5+	2.5+	20	
Munich . . .	84.75	North	0.47	} 1.35	29.5	13	52	0.77+	1.47+	22.5	13	58	
		East	1.26		35.5	1.25+	24.2
Strassburg . .	82.91	North 30° east	} 0.28	0.59	0.75	16	14	02.6	
		East	0.47	20	14	01.3
Tortosa . . .	85.65	Average	1.36	16.4	
Pavia	86.20	Northeast	2.7	} 0.28	27	13	56	2.2	15.7	14	04	
		Southwest	3.1	3.3	16.4	14	03	
Vienna	86.37	North	0.19	} 0.28	26.2	13	59	0.13	0.16	18.8	14	08	
		East	0.21		23.4	0.14	16.9	14	08	
Triest	87.74	North	} 1.4	1.1	} 1.4	18	} 14	06	
		East	0.1	17					
		Vertical	0.9	1					
Budapest . . .	87.93	North ⁷	} 1.42	1.42	15	
		North ⁸	2.5	26
O'Gyalla . . .	88.08	North ⁶	} 1.06	1.06	26	
		East ⁶	0.33	17	14	02	
Florence (Xi-meniano) .	88.23	North ⁵	} 19	0.64?	19	14	00.5	
		East ⁵	4.1	17.6
Zagreb	88.33	North ⁶	} 2.8?	3.9?	21	14	01	
		East ⁶	2.8?	21	14	01	
Pola	88.33	North	} 1	1	20.4	14	04	
		East	1.9	20.4	14	02	
Quarto-Castello .	88.40	North	} 10.1	10.1	30	14	04	
		East	1.18	19	14	05	
Zi-ka-wei . . .	88.49	East	} 0.5	0.5	26.4	13	58	
		East	0.39	29.6	14	09	
Rocca di Papa .	90.48	Northwest	} 1.1	1.1	19	
		North	0.82	} 1.4	17	14	07.3	
Carloforte . . .	90.71	East	} 1.14	1.14		17
		Northwest	0.6	} 0.85	17	14	07	
		Northeast	0.6		17	14	07	
Sarajevo . . .	90.89	North	} Small	Small	
		East	0.53	24.5	14	03.7	
		East	0.46	17.6	14	10.5	
Caggiano . . .	92.63	East	} 0.43	0.43	17	14	14.7	
		Northwest	1.0		32	13	59.5	0.68	19.9	14	07.3	
Taihoku . . .	92.75	Northeast	} 2.2+	2.2+	25.3	14	04.2	
Sofia	93.58	East		} 0.25	0.25	22	14	00
		North	0.48	24		14	01.5
Messina	94.67	Northwest	} 1.66	1.66	} 1.7	22	14	07.8	
		Northeast	0.3		21	14	07.8	
		Vertical	0.25		22	14	07.8	
Catania	95.04	Northeast	0.58	} 30	13	57.5	
		Northwest	0.72	0.8	18	14	12.8	
Taschkent . . .	99.86	Northwest	} 0.72	0.72	18	14	07.1	
		North ⁷	3.0	24	14	10.9	
Manila	100.46	East ⁷	} 20	20	32	14	21.3	
		East-northeast	0.75		0.84	25	14	01	0.44	18	14	08
Batavia	124.99	North-northwest	0.45	} 0.4	18	0.4	} 0.6	18	
		North	0.38		23	14	17.5	0.24		18.4	14	30.6

¹ Rebeur-Paschwitz.
² Wiechert.

³ 17,000 kg.
⁴ 1,200 kg.

⁵ Vicentini.
⁶ Konkoly.

⁷ Bosch-Omori.
⁸ Stiattei.

MAGNETOGRAPH RECORDS.

Several magnetographs at stations not very distant from the origin recorded the shock. These have been examined by Dr. L. A. Bauer,¹ who finds that the time of disturbance on the magnetograph corresponds to the time of arrival of the principal part, and concludes, therefore, that the effect is entirely mechanical and not magnetic. The following table shows the time of the magnetograph records and the time of arrival of the regular waves, according to Dr. Bauer.

TABLE 20. — *Times of Magnetograph Records.*

STATION.	DISTANCE.	MAGNETOGRAPH RECORD.		REGULAR WAVES.	
		<i>h.</i>	<i>m.</i>	<i>h.</i>	<i>m.</i>
	°				
Sitka	20.7	13	22.9	13	22.6
Baldwin	21.8	13	24
Toronto ¹	32.9	13	25.3	² 13	24.5
Honolulu	34.6	13	27.8	³ 13	28.5
Cheltenham	35.6	13	30	13	30
Porto Rico	53.4	Not recorded		

¹ The Toronto record was communicated by Mr. R. F. Stupart, director of the Canadian Meteorological Service. The records of the other stations are taken from Dr. Bauer's article.
² Time of the second preliminary tremors; the regular waves are 3.4 minutes later.
³ Not determined from the seismogram, but from the hodograph curve, plats 2.

It will be seen that the magnetographs recorded only during the time of the strong motion, which convinces us that they acted mechanically like seismographs, for if they had been affected by a magnetic disturbance due to the earthquake, the effect would have been produced long before the arrival of the slow surface waves; indeed, before the arrival of any elastic waves in the mass of the earth. The maximum disturbance of the Toronto declination needle occurred at 13^h 33.6^m; and the maximum recorded by the seismogram at 13^h 33.3^m.

Baldwin, Kansas (lat. 38° 47' N., long. 95° 10' W.), is the only one of these stations that did not have a seismograph; and the magnetograph record began about 1.5 minutes after the regular waves must have reached there according to the hodograph. Being in the middle of the United States, far from any seismographic station, an accurate record at Baldwin would have been valuable; but the time scales of magnetographs are too small to yield close time values; and they do not, in general, record before the strong motion. The Baldwin record is therefore only valuable in so far that it does not contradict the results obtained from regular seismographs; and we can not hope that magnetograph records in the future will, in general, be important additions to the records of seismographs.

¹ "Magnetograph Records of Earthquakes with Special Reference to the San Francisco Earthquake." *Terrest. Magn. and Atmos. Elect.*, 1906, vol. xi, pp. 135-144.

CONCLUSIONS.

The comparative study of the seismograms made by instruments of such varied types brings out the advantages and disadvantages of the various types and of the devices used in making the record.

Time. — It is extremely important that the seismograms should record accurate time. Errors may be due either to errors in the clock or to the methods of recording the time. It is to be supposed that in most observatories the error of the time-marking clock is pretty accurately known, but in some cases it seems almost impossible to escape the conviction that sufficient care has not been given to this subject.

The time marks are sometimes made by the recording point itself, or by an eclipse of the record in the case of instruments registering photographically. Neither of these methods introduces any error. If instruments record the time by special devices marking on the paper, either very close to the record or off to the side, a correction must then be made for "parallax," or the distance between the recording point and the time-marking point. Frequently the pendulum is slightly out of the medial position of equilibrium, and the recording point is displaced to the side; the value of the parallax then changes and some special care is needed to avoid introducing an error in the determination of the time. When the time marks are made at the side of the record, 5 or 10 cm. from the recording point, it is very difficult to carry over the time from them to the record without making an error.

Undamped instruments. — The larger number of instruments in use are not damped. The effect of this is to cause a very uneven magnifying power for vibrations of different periods. This is shown clearly in fig. 47, page 173, where the magnifying power of undamped instruments is seen to increase rapidly with the period of the waves, reaching infinity when this period equals that of the pendulum; and it then diminishes again with longer periods. It is evident, therefore, that an undamped instrument will not accurately reflect the character of the disturbance, but will unduly magnify the vibrations whose periods approach concordance with its own. There are numerous examples of this in the seismograms of the California earthquake. When the amplitude of the recording point has gone beyond the limits of the instrument it has almost invariably been due to abnormally high magnifying powers, caused by concordance of periods, and therefore it does not correspond necessarily, or even usually, with the time of greatest earth movements at the recording station. For instance, Porto d'Ischia and Grande Sentinella, within a few kilometers of each other, have picked out and emphasized waves of different periods.

With undamped instruments it is impossible to determine the magnifying power when the periods of the vibration and the pendulum approach each other; it can only be done satisfactorily when the wave period is less than half or greater than 1.3 times that of the pendulum. As many instruments have periods lying between 15 and 20 seconds, which correspond to the periods occurring during the principal part, we are frequently unable to determine their magnifying power and the true amount of the disturbance. Long-period instruments would give better results for short-period vibrations, and *vice versa*; but the magnifying power of short-period instruments for long periods is very greatly reduced. For instance, the Vicentini pendulum at Manila has a mechanical magnifying power of 100. Its period was 2.4 seconds during the strong motion; the period of the waves was 25 seconds; and the actual magnifying power of the instrument for these waves was a little less than 1.

Damped instruments. — Of the instruments which were damped the majority were not damped enough. There are two great advantages in strong damping. The pendulum has a more uniform magnifying power for waves of different periods, and it takes up the true movement more quickly. The curves in fig. 47 show the variations in magnifying powers for different periods and for different degrees of damping. Where the damping is insufficient there is a distortion of the record, as in the case of undamped instruments, but to a less degree. It will be noticed that when the damping ratio is 8 : 1 the magnifying power is nearly constant for all periods shorter than that of the pendulum itself. For longer vibration periods the magnifying power gradually diminishes, but not excessively. When the vibration period is twice as long as that of the pendulum the magnifying power is about 0.8 as great as it would be for an undamped pendulum; and for periods longer still the magnifying power becomes more nearly equal to that of an undamped instrument.

With the damping ratio mentioned the free movement of the pendulum dies out very rapidly. If the pendulum is displaced 64 mm. and allowed to swing freely its amplitude will die down to 1 mm. after one whole vibration. Therefore the free movement of the pendulum will always disappear rapidly, and it will record pretty closely the true movement of the ground. Prince Galitzin advocates "dead-beat" instruments, where the damping is in the proportion 8 : 1. Under this heavy damping he has shown by experiment that the free movement disappears immediately and the pendulum follows very closely the movement of the ground; but the curve in fig. 47 shows that the magnifying power is not constant, but varies continuously for different periods, and therefore a calculation must always be made before we can compare the relative amplitudes in different parts of the record. It seems to me therefore that the most advisable damping ratio is 8 : 1.

Period of the pendulum. — If the vibrations have a much longer period than the pendulum, the magnifying power of the instrument is greatly reduced. The advantage of long periods in undamped pendulums is that they hold up the magnifying power for long-period waves. For waves of very short period there is no advantage in giving a long period to the pendulum. For instance, other things being equal, a pendulum with a period of 10 seconds and one with a period of 60 seconds would have practically the same magnifying power for waves whose period was 1 second.

We have seen that when the instrument is damped in the ratio of 8 : 1 the magnifying power varies little for periods up to that of the pendulum; and, therefore, the longer the latter the greater the range over which the magnifying power will be practically constant. A pendulum whose period is 30 seconds and which is damped in this ratio will give a very correct record of the relative amplitudes in all parts of the seismogram; for waves having a longer period than this are not very frequent.

Magnifying power for short periods. — Among the instruments which recorded the California earthquake magnifying powers for very short periods of 2 or 3, 6 or 7, 10, 15, 25, 100, and more, are found. The majority of those with low magnifying powers gave unsatisfactory determinations of the beginning of the shock, even at stations less than 90° distant; and for greater distances than this the beginning in general was not recorded at all. We have been unable to determine the time of the arrival of the beginning of the shock at the very distant stations, as they are all provided with low magnifying instruments. This is most unfortunate, for it is true not only in the case of the California earthquake but of all other shocks whose times and origins are accurately known; and therefore our knowledge of the velocity of propagation to very great distances is still quite vague. To get satisfactory records of earthquakes at distances more than 100° it is necessary to have instruments with magnifying powers of at least 100.

Time scale. — A great variety of time scales were used, from 1 mm. to the minute, or even less, up to 15 mm. to the minute; and in one case, at Göttingen, the scale was 60 mm. to the minute. The advantage of the open time scale is that individual vibrations are recorded, making it possible to determine their period and the magnifying power of the instrument for them; and the characteristics of the motion can be seen. This can not be done on seismograms with small time scales. On the other hand, when the movement begins very gently it is extremely difficult, on the open time scale, to determine where the slight waves in the line begin; but they would appear much more clearly on seismograms with small time scales. Wherever the magnifying power is sufficiently great there is no difficulty in determining the time of the beginning, and the advantage of a time scale of 10 or 15 mm. to the minute, in permitting the period of the vibration to be determined, is very great.

Identification of the phases on the seismograms. — The seismograms made by different instruments differ greatly among themselves, and it is very often extremely difficult to decide exactly where a particular phase begins. Where the magnifying power is sufficiently large this difficulty is not serious for the first and second preliminary tremors, but it often is for the regular waves and the subsequent phases. Where the magnifying power is small there is great difficulty in deciding upon the time of the beginning of the first preliminary tremors. It is therefore of very great importance, in studying the propagation of an earthquake disturbance, to have copies of the seismograms themselves, and not merely the recorded times as determined by the directors in charge of the instruments. For without doubt, different persons examining single seismograms, without comparison with others, would frequently take different parts of the movement to represent the beginning of a particular phase.

APPENDIX
THEORY OF THE SEISMOGRAPH

THEORY OF THE SEISMOGRAPH.

INTRODUCTION.

In the early development of seismographs the attempt was made to produce a "steady point"; that is, a point that will remain at rest when the earth is set in motion by an earthquake. If then the relative motion of the "steady point" and the earth were recorded, we should have the actual movement of the earth. The "steady point" must be supported against gravity, and therefore all seismographs must consist of a support connected with the earth and moving with it, and a mass, held up by the support in such a manner that it will partake as slightly as possible of the latter's movements; let us call this portion the "pendulum." We must also have a method of recording the motion of the pendulum relative to the support. If the pendulum were exactly in neutral equilibrium for any movement of the support, we should have a truly "steady point," but this can not be realized; a movement of the support exerts forces on the pendulum which set it in motion, and the problem therefore presents itself: to determine the actual movement of the support from the movement of the pendulum relative to the support. The only possible way to do this is to analyze this relative movement, and thru the laws of mechanics work out the movement of the support. We must therefore develop the mechanical theory of the instrument.

Let us first note that all movements can be broken up into a displacement and a rotation; and these can be resolved into three component displacements parallel to three axes at right angles to each other, and three rotations around these axes; and therefore the instruments must be made to record the three displacements and the three rotations in order completely to determine the movement. We shall see that instruments have not been made which will be only affected by one component of the motion, but in many cases the other components may be relatively so unimportant that they may be neglected; or by means of several instruments, we can, by elimination, determine the several components. Earthquake disturbances are propagated as elastic waves of compression or distortion; and even at a very short distance from the origin, the movements of the earth-particles are vibrations about their positions of equilibrium. Surface-waves also exist, in the propagation of which gravity does not play a part.

In the immediate neighborhood of severe earthquakes the vibratory displacements may be measured by centimeters, but at a distance of 1,000 km. or more the displacements are of the order of millimeters, a displacement of 5 mm. being a very large one; and the horizontal and vertical displacements are of the same general order. Up to the present our instruments have not separated the linear displacements from the rotations, but we can calculate what the rotations should be with given linear displacements, as follows.

ROTATIONS DUE TO EARTH WAVES.

Let us first take the case of a simple harmonic wave where the movement of the particles is transverse to the direction of propagation; the equation is

$$y = A \sin 2\pi \left(\frac{t}{P} - \frac{x}{\lambda} \right) \quad (1)$$

where

- y is the variable displacement of the earth particles,
- A the maximum displacement or amplitude,
- t the time,
- x the distance along the direction of propagation,
- P the period of vibration,
- λ the wave length.

This represents a wave traveling in the positive direction of x ; the displacement y may be in any direction perpendicular to x , and in general it may be broken up into vertical and horizontal components. In figure 32, let x be the direction of propagation, and y may be either vertical or horizontal;

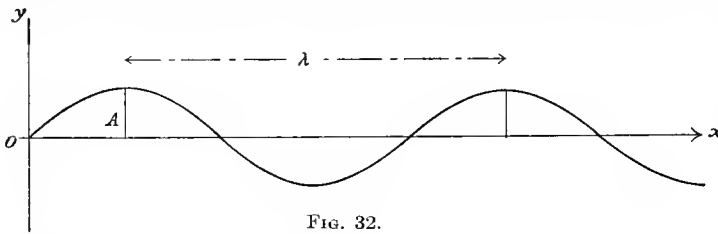

FIG. 32.

since all the earth particles move parallel to y , a line in this direction is not rotated at all; whereas a line parallel to x is made to assume the wave form, and its elements experi-

ence the maximum rotation. The tangent of the angle which an element of the line makes with the axis of x is given by the difference in the displacements of two neighboring points divided by their distance apart, *i.e.*, by dy/dx ; but

$$\frac{dy}{dx} = -2\pi \frac{A}{\lambda} \cos 2\pi \left(\frac{t}{P} - \frac{x}{\lambda} \right) \quad (2)$$

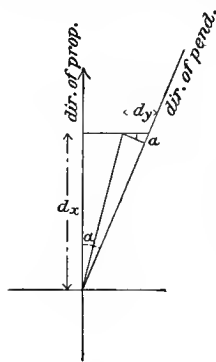

FIG. 33.

and its maximum value is $2\pi A/\lambda$. If v is the velocity of propagation, $\lambda = vP$. The waves of largest amplitude have a velocity of about 3.3 km. per second, and a period of 15 to 20 seconds; and hence a wave length of from 50 to 66 km. If we take $A = 5$ mm., which is a very large amplitude, and $\lambda = 66$ km., we find $2\pi A/\lambda = 6.3 \times 5/66 \times 10^6 =$ about 5×10^{-7} or one-tenth sec. arc. As small as this angle is, the most sensitive instruments are capable of measuring it, provided the rotation is around a horizontal and not the vertical axis. If two horizontal pendulums were supported by the

solid rock and placed one with the beam pointing in the direction of the propagation of the wave, and the other at right angles to it, then if the displacements were horizontal, that is, if the rotation was around a vertical axis, the first pendulum would suffer a slight relative rotation, but the second one would not. If, however, the displacements were vertical, and the rotation around a horizontal axis, the second pendulum would be displaced and the first would not.

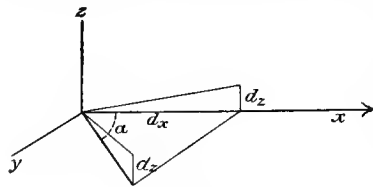

FIG. 34.

In the more general case where the direction of propagation makes an angle α with the direction of the horizontal pendulum we find the relative rotation of the pendulum for horizontal displacements to be $\cos^2 \alpha \cdot dy/dx$, obtained by dividing $\cos \alpha \cdot dy$ by the length of the line; *i.e.*, by $dx/\cos \alpha$, as shown in figure 33. If we had a second pendulum at right angles to the first, the amount of its relative rotation would be $\sin^2 \alpha \cdot dy/dx$, and the direction of the 2 rotations would always be the same. In the case of vertical displacements the rotation of a horizontal line making an angle α with the direction of

propagation is $\cos \alpha \cdot dy/dx$, as will readily appear from figure 34. A line making a vertical angle α with the horizontal direction of propagation would be turned thru an angle $\cos^2 \alpha \cdot dy/dx$, but this line does not interest us, nor does the corresponding line in the case of horizontal displacements, which would have a rotation of $\cos \alpha \cdot dy/dx$.

These conclusions depend on the assumption that the support of the seismographs has exactly the same motion as the underlying rock, or that the column supporting the pendulum is fastened rigidly to the rock; if, however, the seismograph rests on a pier, even tho it be connected rigidly with the solid rock, the case is different. The movement is communicated to the base of the pier, and as its sides are subjected to no constraining forces, the top of the pier, in the case of horizontal displacements, would probably rotate around a vertical axis nearly like a rigid body, thru an angle equal to the average rotation of all lines in its base; that is, thru an angle μ , such that

$$\mu = \frac{1}{2\pi} \int_0^{2\pi} \frac{2\pi A}{\lambda} \cos^2 \alpha \cdot d\alpha = \frac{1}{2} \frac{2\pi A}{\lambda} \quad (3)$$

or half the maximum rotation in the solid rock. We assume that the natural period of the pier for rotational vibrations is so much shorter than the period of the earthquake wave that it does not exert an appreciable influence on the amount of the rotation; this assumption seems entirely justified.

In the case of vertical displacements the pier would be tilted thru an angle equal to the tilt of the rock, but its top would also have quite a large linear displacement. If, however, the pier were very long, its period might be comparable to that of the shorter earthquake waves, and the instrument would record movements which would be a combination of the movements of the ground with the proper movements of the pier. It is probable that the movements of high chimneys and tall buildings would be materially affected by their natural periods of vibration.

Let us now consider waves of condensation, like sound waves, where the direction of the displacement, ξ , is the same as that of propagation, x ; the equation of the wave will still have the same form as heretofore. A line in the direction of propagation or at right angles to it, horizontal or vertical, will have no rotation; a horizontal line making an angle α with x will suffer a difference of displacement of its two ends equal to $d\xi$, or $d\xi \sin \alpha$ at right angles to its length; its length is $dx/\cos \alpha$; therefore its rotation is $\sin \alpha \cos \alpha \cdot d\xi/dx$; the maximum value of this is $\pi A/\lambda$, when $\alpha = 45^\circ$ and when $d\xi/dx$ is a maximum. This is a rotation around the vertical axis. A line making an angle α on the opposite side of the line of propagation is rotated in the opposite direction; it is probable that the top of the pier would not rotate at all about the vertical, when the base is subjected to this kind of motion. Observers have not so far succeeded in directly measuring rotations; and as we should expect them to be extremely small, we shall so consider them until further evidence shows them to be larger.

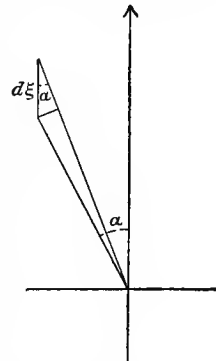

FIG. 35.

FORMS OF SEISMOGRAPHS.

The forms of instruments which have proved practical for recording very small disturbances are: the ordinary pendulum, the horizontal pendulum, and the inverted pendulum. The first form is too familiar to need any explanation; the second is a frame or a bar carrying a heavy mass, supported at two points nearly in a vertical line, as a door is supported by its hinges; so that its position is affected by a small displacement of the support at right angles to the direction toward which it points; the inverted pendu-

lum is a heavy mass whose center of gravity is vertically above the point of support; some additional forces must be applied in order to keep it in stable equilibrium in this position; these forces are usually supplied by springs connecting the upper part of the mass and the support.

REGISTRATION.

There are two principal methods of magnifying and registering the relative movements, the photographic and the mechanical. It is to be noticed that these relative movements are all of the nature of rotations of the pendulum about a point or a line of the support. The photographic method of registering may be divided into two kinds, the optical and the direct. In the optical method a beam of light from a stationary point is reflected from a mirror on the pendulum and concentrated on a moving sheet of photographic paper which is afterwards developed. Time marks are made by periodically eclipsing the light. The magnifying power depends on the distance of the recording paper from the mirror. In the direct method the light is reflected through a longitudinal slit in a diaphragm on the end of the pendulum's beam and a transverse slit in the top of a box, to the moving photographic paper below. As long as the pendulum is still, a straight line is recorded on the paper, but when the pendulum swings, the line is shifted from side to side. The magnifying power depends on the ratio of the length of the beam to the distance of the center of oscillation from the axis of rotation. In the mechanical method of registering the record is made by a pen on white paper or by a stylus on smoked paper. The marking point may be fastened directly to the pendulum or may be connected with it thru one or more multiplying levers.¹

THE MATHEMATICAL THEORY.

The mathematical theory of seismographs has been written by Dr. W. Schlüter,² E. Wiechert,³ Prince B. Galitzin,⁴ Gen. H. Pomerantzeff,⁵ Professor O. Backlund,⁶ Dr. M. Contarini,⁷ and Dr. M. P. Rudski,⁸ but up to the present the general theory has not been written in English. Messrs. Perry and Ayrton, however, published an important paper in 1879,⁹ in which they developed the mathematical theory of a heavy mass suspended by springs in a box supposed to move with the earth. They emphasized the fact that the actual motion of the mass is made up of that of the earth and of its proper vibration; they showed the influence of damping and the relation between the relative movement and the motion of the earth. This paper seems to have been overlooked and is not referred to by later writers on the theory.

¹ It is not desirable here to give details of construction. They will be found in Milne's *Earthquakes and Seismology*; in Dutton's *Earthquakes*, in Sieberg's *Erdbebenkunde*, and in the original descriptions in memoirs of scientific societies. Dr. R. Ehlert describes many forms of instruments in *Gerland's Beiträge zur Geophysik*, 1896-1898, vol. III, pp. 350-475.

² *Schwingungsart und Weg der Erdbebenwellen*. *Gerland's Beiträge zur Geophysik*, 1903, vol. V, pp. 314-360, 401-466.

³ *Theorie der automatischen Seismographen*. *Abhand. Kön. Gesells. Wissen. Göttingen, Math. Phys. Kl.* 1902-1903, Bd. II, pp. 1-128.

⁴ *Ueber Seismometrische Beobachtungen*. *Acad. Imp. Sciences. St. Petersburg*, 1902. *Comptes Rendus Commission Sismique Permanente*. Liv. 1, pp. 101-183. *Zur Methodik der Seismometrischen Beobachtungen*. Same, 1903. T. I. Liv. 3, pp. 1-112. *Über die Methode zur Beobachtungen von Neigungswellen*. Same, 1905, T. II. Liv. 2, pp. 1-144. *Die Electromagnetische Registrirmethode*, Same, 1907, T. III. Liv. 1, pp. 1-106.

⁵ In Russian, Same, pp. 185-208.

⁶ *Formeln für das Horizontalpendel*. Same, pp. 210-213.

⁷ *Rend. d. R. Accad. d. Lincei. Cl. Sci. fis. math. e. nat.*, 1903, vol. XII, pp. 507-515, 609-616.

⁸ *Ueber die Bewegung des Horizontalpendels*. *Gerland's Beiträge zur Geophysik*, 1904, vol. VI, pp. 138-155.

⁹ *On a Neglected Principle that may be employed in Earthquake Measurements*. *Phil. Mag.*, 1879, vol. VIII, pp. 30-50.

Dr. Schlüter's work was undertaken to determine if the movements of seismographs due to distant earthquakes were caused by linear displacements or by tilts; and he develops the theory for these two kinds of motion separately. He discusses the effect of damping and shows the relation between the movement of the earth and that of the seismograph.

Professor Wiechert begins by giving the theory of the ordinary pendulum in a very simple way, which does not, however, show the degree of approximation made; he then develops the general theory of seismographs without considering specifically the characteristics of each form. An extremely valuable part of the memoir is the study of the solid and viscous friction and their influence on the movement of the pendulums; also the relation between the amplitude of the pendulum relative to the support and the amplitude of the support, when the latter is moving in a simple harmonic vibration, for various values of the ratio of the period of vibration of the support and the natural period of the pendulum, and for various degrees of damping.

Prince Galitzin treats many forms of seismographs with considerable fullness. He develops the equations through Lagrange's equations and shows what terms are neglected and the degree of approximation secured. The physical origin of certain terms in his equations are not evident, and he treats his pendulums as mathematical pendulums, that is, as though the mass were concentrated at the center of oscillation; certain terms which contain the moment of inertia about the center of gravity do not appear in his equations; this is unimportant as they are in general negligible. Prince Galitzin has also developed a method of electromagnetic recording, and has given the theory of the instrument. This instrument offers some special advantages, but it has not yet come into general use. An important part of Prince Galitzin's work consists of an experimental verification of the theory by means of a moving platform, which imitates the movements produced by distant earthquakes.

Professor Backlund starts from Euler's equation and obtains the equation of the horizontal pendulum under disturbance, but he does not consider either viscous or solid friction.

Dr. M. Contarini treats the seismograph as a series of connected links, and develops the theory in symbolic form.

Dr. Rudski develops the equations of the horizontal pendulum through Lagrange's equations, retaining quantities of the second order. Under these conditions he finds that in the case of periodic movements of the ground, the terms containing the damped free period of the pendulum are no longer periodic. In cases where the damping is large or the movement of the pendulum small, this peculiarity is unimportant.

In the following pages we shall develop the equations of relative motion of the pendulum from the two fundamental laws; namely, the motion of the center of gravity, and Euler's equations for angular accelerations about moving axes. We shall see the order of the terms neglected, and the physical origin of the terms in our resulting equations will be evident. We shall begin with the horizontal pendulum, as the lever used for magnifying the motion with ordinary mechanical registration is itself a horizontal pendulum and the equation of its motion must supply terms in our resultant equations. We shall also assume an arbitrary position for the origin of coördinates, and determine what position of this origin will give the simplest equation; we shall find this to be the center of gravity of the pendulum in its undisturbed position. Although I have followed a different route in developing the equation of the seismograph from those followed by the investigators mentioned, I wish to acknowledge my indebtedness to them for the guidance I have received from their researches.

- i , the inclination during the disturbance;
 θ , the angular displacement of the CG relative to the support, the positive direction being the same as that of ω_x ;
 l , the perpendicular distance from the CG to the axis of rotation at O' ;
 X, Y, Z , the absolute coördinates of O' before the disturbance;
 x, y, z , the absolute coördinates of the CG at any time;
 F , the force applied at O' ;
 F_x, F_y, F_z , F_1, F_2, F_3 } its components parallel to the fixed axes and to the moving axes, respectively.
 f_x, f_y, f_z , f_1, f_2, f_3 } the components of the force exerted on the pendulum by the indicator;
 M , the mass of the pendulum;
 I_1, I_2, I_3 , the moments of inertia of the pendulum about the principal axes of inertia through the CG ;
 ξ, η, ζ , the linear displacements of the support due to the disturbance;
 $\omega_x, \omega_y, \omega_z$, $\omega_1, \omega_2, \omega_3$ } the angular displacements around the axes, due to the disturbance, the positive directions being indicated in the figure.

For the sake of clearness the displacements of the support are not shown in the figure, but they can easily be imagined.

The linear accelerations of the CG are given by the equations

$$M \frac{d^2x}{dt^2} = F_x + f_x \quad M \frac{d^2y}{dt^2} = F_y + f_y \quad M \frac{d^2z}{dt^2} = F_z - Mg \quad (4)$$

In order to see exactly what approximations we make, we must use Euler's equations for moving axes to determine the angular accelerations; the motion is referred to the instantaneous position of the 3 principal axes of inertia thru the CG , which we have called (1) (2) and (3) respectively; as we only observe the rotation around (3) we may neglect the equations referring to the other axes; the equation is

$$I_3 \frac{d^2\mu}{dt^2} - (I_1 - I_2) \frac{d\omega_1}{dt} \frac{d\omega_2}{dt} = C_3 \quad (5)$$

where μ is the absolute angular acceleration around the instantaneous position of the axis (3), and C_3 is the moment of all forces around this axis. As the pendulum has no relative motion around the axes (1) and (2), its angular velocities around their instantaneous positions are the same as those of the support. Since the support is supposed to move with the underlying rock, its angular displacement will be the same as that of the rock, and will be given by equation (2). Its angular velocity will be obtained by differentiating this equation with respect to the time, we thus find:

$$\frac{d\omega_1}{dt} (\max) = \frac{(2\pi)^2 A}{\lambda P} \quad (6)$$

and with the values there used: $A = 5$ mm., $P = 20$ secs.; $\lambda = 66$ km., this becomes about 3×10^{-7} ; and $d\omega_2/dt$ has a value of the same order. We may write (as we shall see further on)

$$\mu = \Theta \cos \left(\frac{2\pi}{P} \right) t; \quad \frac{d^2\mu}{dt^2} (\max) = \left(\frac{2\pi}{P} \right)^2 \Theta \quad (7)$$

making $P = 20$ secs. and $\Theta = 0.005$, which is probably a smaller value than it would have under the assumed disturbance, we find the maximum value of the relative angular acceleration of the pendulum to be about 5×10^{-4} , a quantity far larger than the product of the two angular velocities given above. We may, therefore, without appreciable error, neglect the second term of equation (5).

The reactions of the support have been replaced by a single force F applied at O' and a couple. The forces of the couple both pass thru the axis of rotation and therefore can not have a component around it, or around a parallel axis thru the CG . Of the components of F , F_2 passes through the CG ; F_3 is parallel with (3), and therefore F_1 alone is capable of exerting a moment around (3). Similarly only the f_1 component of f can exert a moment around (3). If the latter force is exerted at a point distant l_1 from O' , we find

$$C_3 = F_1 l - f_1 (l_1 - l) \quad (8)$$

Let us replace $d^2\mu$ by $d^2(\theta + \omega_3)$, which expresses the angular acceleration in terms of the acceleration of the pendulum relative to the support, and the acceleration of the support; with these substitutions the equation of angular acceleration (5) becomes

$$I_3 \frac{d^2(\theta + \omega_3)}{dt^2} = F_1 l - f_1 (l_1 - l) \quad (9)$$

We must now replace F_1 by its value in terms of the resolved parts of F_x, F_y, F_z in the direction of (1), and then the values of these latter quantities must be obtained from equation (4).

We have

$$F_1 = F_x \cos(x, 1) + F_y \cos(y, 1) + F_z \cos(z, 1) \quad (10)$$

Since the rotations are the same for all points, we can determine the cosines of the angles in the above equation, by assuming a sphere of unit radius with center at O' , and determining the displacements of the axes on its surface as a result of the rotations (ω 's) and the relative angular displacement (θ). These values follow directly from figure 37, where the points represent the intersections of the axes with the surface of the sphere and the lines represent the displacements of these points.

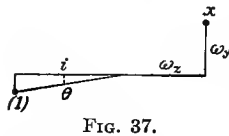

FIG. 37.

$$\begin{aligned} \cos(x, 1) &= \cos(\omega_x + \theta) = 1 - \frac{\theta^2}{2} \\ \cos(y, 1) &= \sin\left\{\omega_y + \theta\left(1 - \frac{i^2}{2}\right)\right\} = \omega_y + \theta \\ \cos(z, 1) &= -\sin(\omega_z + i\theta) = -(\omega_z + i\theta) \end{aligned} \quad (11)$$

All the angles are small, and i and θ are considerably larger than the ω 's; we have therefore neglected squares of the ω 's, products of ω 's and θ , and $i^2\theta$; but $i\theta$ is an important term in our equation; and since θ^2 is of the same order, these terms must be retained.

Substituting the values of these cosines and the values of F_x, F_y, F_z , from equations (4), in equation (10) we get

$$F_1 = \left(M \frac{d^2x}{dt^2} - f_x\right) \left(1 - \frac{\theta^2}{2}\right) + \left(M \frac{d^2y}{dt^2} - f_y\right) (\omega_y + \theta) - \left(M \frac{d^2z}{dt^2} + Mg\right) (\omega_z + i\theta) \quad (12)$$

The coördinates of CG_0 are $X, Y + l, Z - il$; the coördinates of CG_s , during the disturbance, are

$$\begin{aligned} \xi + X + (Z - il)\omega_y - (Y + l)\omega_x \\ \eta + Y + l + X\omega_z - (Z - il)\omega_x \\ \zeta + Z - il + (Y + l)\omega_z - X\omega_y \end{aligned} \quad (13)$$

and the coördinates of CG during the disturbance are

$$\begin{aligned} x &= \xi + X + (Z - il)\omega_y - (Y + l)\omega_x - l\theta \\ y &= \eta + (Y + l) + X\omega_z - (Z - il)\omega_x \\ z &= \zeta + (Z - il) + (Y + l)\omega_z - X\omega_y \end{aligned} \quad (14)$$

The rotations are so small that we may neglect the order in which they are effected, and their coefficients may be considered constants. Differentiating, we get

$$\begin{aligned}\frac{d^2x}{dt^2} &= \frac{d^2\xi}{dt^2} + (Z - il) \frac{d^2\omega_y}{dt^2} - (Y + l) \frac{d^2\omega_z}{dt^2} - l \frac{d^2\theta}{dt^2} \\ \frac{d^2y}{dt^2} &= \frac{d^2\eta}{dt^2} + X \frac{d^2\omega_z}{dt^2} - (Z - il) \frac{d^2\omega_x}{dt^2} \\ \frac{d^2z}{dt^2} &= \frac{d^2\zeta}{dt^2} + (Y + l) \frac{d^2\omega_x}{dt^2} - X \frac{d^2\omega_y}{dt^2}\end{aligned}\quad (15)$$

Introducing these values in equation (12), and the value of F_1 thus obtained in equation (9) and writing $I_3 + Mt^2 = I_{(3)}$, the moment inertia around the axis of rotation, we get,

$$\begin{aligned}I_{(3)} \frac{d^2\theta}{dt^2} + I_3 \frac{d^2\omega_3}{dt^2} &= Ml \left[\left\{ \frac{d^2\xi}{dt^2} + (Z - il) \frac{d^2\omega_y}{dt^2} - (Y + l) \frac{d^2\omega_z}{dt^2} - \frac{f_x l_1}{Ml} \right\} \left(1 - \frac{\theta^2}{2} \right) \right. \\ &\quad + \left\{ \frac{d^2\eta}{dt^2} + X \frac{d^2\omega_z}{dt^2} - (Z - il) \frac{d^2\omega_x}{dt^2} \right\} (\omega_z + \theta) \\ &\quad \left. - \left\{ \frac{d^2\zeta}{dt^2} + (Y + l) \frac{d^2\omega_x}{dt^2} - X \frac{d^2\omega_y}{dt^2} + g \right\} i \left(\frac{\omega_y}{i} + \theta \right) \right]\end{aligned}\quad (16)$$

The force f is small; and on account of friction between the pendulum and the indicator, its direction is not accurately known, but as the friction and the angular displacements are small, it is nearly at right angles to both the pendulum and the indicator; we have therefore replaced f_1 in equation (9) by $f_x (1 - \theta^2/2)$ and have neglected the term $f_y (\omega_z + \theta)$ in obtaining equation (16). This is the general equation of the horizontal pendulum seismograph, within the approximations mentioned. The successive lines of the second member give the moments around the axis (3) due to forces parallel to the axes of x , y , and z respectively; (the term $Ml^2 d^2\theta/dt^2$, which has been combined in the first term of the first member, should be restored to the first line of the second member to make the statement strictly true) and the origin of the force represented by each term in the equation is evident.

This equation can be greatly simplified by a proper choice of the origin of coördinates; if we place the origin at O' , we have $X = Y = Z = 0$, and the equation becomes

$$\begin{aligned}I_{(3)} \frac{d^2\theta}{dt^2} + I_3 \frac{d^2\omega_3}{dt^2} &= Ml \left[\left\{ \frac{d^2\xi}{dt^2} - il \frac{d^2\omega_y}{dt^2} + l \frac{d^2\omega_z}{dt^2} - \frac{f_x l_1}{Ml} \right\} \left(1 - \frac{\theta^2}{2} \right) \right. \\ &\quad \left. + \left\{ \frac{d^2\eta}{dt^2} + il \frac{d^2\omega_x}{dt^2} \right\} (\omega_z + \theta) - \left\{ \frac{d^2\zeta}{dt^2} + l \frac{d^2\omega_y}{dt^2} + g \right\} i \left(\frac{\omega_y}{i} + \theta \right) \right]\end{aligned}\quad (17)$$

On putting $I_3 = 0$, omitting $\theta^2/2$, $f_x l_1$ and $l\omega_y d^2\omega_x/dt^2$, and making the proper changes of notation, this becomes the equation No. 86 of Prince Galitzin.¹ Equation (16) can be simplified still more by placing the origin at CG_0 ; then $X = Y + l = Z - il = 0$, and it becomes

$$I_{(3)} \frac{d^2\theta}{dt^2} + I_3 \frac{d^2\omega_3}{dt^2} = Ml \left[\left(\frac{d^2\xi}{dt^2} - \frac{f_x l_1}{Ml} \right) \left(1 - \frac{\theta^2}{2} \right) + \frac{d^2\eta}{dt^2} (\omega_z + \theta) - \left(\frac{d^2\zeta}{dt^2} + g \right) i \left(\frac{\omega_y}{i} + \theta \right) \right]\quad (18)$$

It is evident that this equation can not be simplified further without omitting some of its terms. Referring to the equation of a wave, equation (1); differentiating twice with respect to t we find for the maximum value of the acceleration

$$\frac{d^2y}{dt^2} (max) = \left(\frac{2\pi}{P} \right)^2 A\quad (19)$$

¹ Ueber Seismom. Beobachtungen. Acad. Imp. d. Sci. St. Petersburg. C. R. Com. Sismique Permanente. 1902, Liv. I, p. 142.

with $P = 20$ secs. and $A = 5$ mm., this has a value of about 0.5 mm. per sec. per sec. This is the order of the terms $d^2\xi/dt^2$, $d^2\eta/dt^2$, $d^2\zeta/dt^2$; the last is very small in comparison with g , which is nearly 10,000 mm. per sec. per sec., and may therefore be neglected. $\theta^2/2$ is small in comparison with unity, but it is of the same order as $i\theta$; nevertheless $d^2\xi/dt^2$ is so small in comparison with g , that we may neglect $(\theta^2/2)(d^2\xi/dt^2)$ also; $d^2\eta/dt^2$ is of the same order as $d^2\xi/dt^2$, but it is multiplied by $(\omega_2 + \theta)$, which with some instruments may amount to $\frac{1}{10^6}$; if the accuracy of our measures is not greater than this, we may omit this term in comparison with $d^2\xi/dt^2$. The product $f_x(1 - \theta^2/2) = f_1$. The left-hand member of the equation may be written $Ml^2d^2\theta/dt^2 + I_3(d^2\theta/dt^2 + d^2\omega_3/dt^2)$; the omission of $d^2\omega_3/dt^2$ is equivalent to substituting, in the second term, the angular acceleration relative to the support for the absolute angular acceleration. Since the maximum value of ω_3 is of the order of 5×10^{-7} and the maximum value of θ is of the order of 5×10^{-3} , and since they would have the same period, we find that $d^2\theta/dt^2$ would be about 1,000 times as large as $d^2\omega_3/dt^2$; and since in general I_3 is much smaller than Ml^2 , it is clear that we make no material mistake in omitting $d^2\omega_3/dt^2$. Our equation then takes the form

$$I_{(3)} \frac{d^2\theta}{dt^2} = Ml \left[\frac{d^2\xi}{dt^2} - \frac{f_1 l_1}{Ml} - g i \left(\frac{\omega_y}{i} + \theta \right) \right] \quad (20)$$

In the undisturbed condition the CG lies in the vertical plane containing the axis of rotation, this axis making a small angle i_0 with the vertical. When the instrument is disturbed the position of equilibrium is in the vertical plane containing the axis of rotation in its disturbed position. Using the same device as on page 152, we see by figure 38

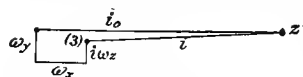

FIG. 38.

that the angle thru which the plane of equilibrium is turned is $-(\omega_y - i\omega_z)/i$; but since the support itself is turned about the vertical thru an angle ω_z , the angular displacement of the plane of equilibrium relative to the support is $-(\omega_y - i\omega_z)/i - \omega_z$, which reduces to $-\omega_y/i$. The last term in equation (20) is therefore the moment due to gravity tending to bring the pendulum back to its position of equilibrium, and it is proportional to the angular displacement from the position of equilibrium.

The value of the new angle i , between the vertical and the axis of rotation, reduces practically to $i_0 - \omega_x$, on account of the small angle thru which the plane of equilibrium has been rotated (see figure 38). Since ω_x is of the order 5×10^{-7} and i_0 for the von Rebeur pendulum, where it has a smaller value than for any other instrument, is about 1:700, we see that its value is about $i:3000$; for other instruments it is still smaller; we may omit ω_x and consider that the inclination of the axis of rotation to the vertical has not been changed by the disturbance.

The equation contains $f_1 l_1$, the moment due to the reaction between the pendulum and the indicator. Its value can be determined from the equation of the indicator and then substituted in equation (20). The indicator is itself a small, horizontal pendulum and is affected by the disturbance; its general equation will be of the form of equation (16). Let us assume that the axis of rotation of the indicator and its cg_0 lie in the axis of y thru the CG_0 of the pendulum; the coördinates of the cg_0 then become 0, l_4 , 0 (see fig. 36); putting these values for X , $Y + l$, $Z - il$, in equation (16) and writing primes to mark the quantities referring to the indicator, its equation becomes

$$I_{(3)}' \frac{d^2\theta'}{dt^2} + I_3' \frac{d^2\omega_z}{dt^2} = M'l' \left[\frac{d^2\xi}{dt^2} - l_4 \frac{d^2\omega_z}{dt^2} + \frac{f_1' l_2}{M'l'} + \frac{d^2\eta}{dt^2} (\omega_z + \theta') - \left(\frac{d^2\xi}{dt^2} + l_4 \frac{d^2\omega_z}{dt^2} + g \right) \omega_y \right] \quad (21)$$

f_1' has a positive sign because the force is applied so that a positive force causes a positive angular acceleration; we have assumed $i = 0$, and that the reaction between the

indicator and the pendulum acts at right angles to the former and is equal to its (1) component. These assumptions will not be accurately true, but the quantities involved are small, and no important error will be introduced by them. Even in this form the equation is very complicated, but it can be made very simple by constructing the indicator so that its *cg* shall lie in its axis of rotation, then l' becomes 0, and only one term remains on the right-hand side. In this case $I_{(3)'} = I_3'$; but θ' is several times as large as θ , so that as shown on page 154 we may omit $I_3' d^2\omega_3/dt^2$, and the equation of the indicator takes the simple form

$$I_{(3)'} \frac{d^2\theta'}{dt^2} = f_1 l_2 \quad (22)$$

With the *cg* in the axis of rotation it makes no difference where this axis is situated, and the indicator may even be a bent lever without changing its equation; this method of reducing the influence of the indicator is so simple that it should always be followed. In this paper we shall assume that it has been; if it has not we must either take into account the various terms of equation (21) or we must look upon them as unimportant and neglect them.

We have, of course, $f_1' = -f_1$; also $\theta' = -n_1\theta$, where $n_1 = l_1/l_2$, and hence $d^2\theta'/dt^2 = -n_1 d^2\theta/dt^2$; eliminating f_1' from equation (20) by means of equation (22), and making the above substitutions, we get

$$(I_{(3)} + n_1^2 I_3') \frac{d^2\theta}{dt^2} = Ml \left[\frac{d^2\xi}{dt^2} - gi \left(\frac{\omega_y}{i} + \theta \right) \right] \quad (23)$$

It will be seen that the moment of inertia of the pendulum is practically increased by n_1^2 times the moment of inertia of the indicator, and this tends to diminish the angular acceleration; whereas the mass of the pendulum which appears on the right side of the equation and tends to increase the acceleration is not affected by the indicator; hence the importance of making the indicator as light as possible. If for the sake of increasing the magnifying power of the pendulum we should add a second lever to be deflected by the first, and if the ratio of the angular deflections of the second and first levers be n_2 , then the effective moment of inertia of the two levers is $I_{(3)'} + n_2^2 I_{(3)''}$, and that of the whole system is $I_{(3)} + n_1^2 I_{(3)'} + n_1^2 n_2^2 I_{(3)''}$; tho the magnifying power may be increased by a multiplication of levers, the actual deflections of the pendulum are diminished and it may be materially. In the Bosch-Omori 10 kilog. seismograph $I_{(3)} = 61.6 \times 10^6$ cm.²gm.; $I_{(3)'} = 280$ cm.²gm.; and when the magnifying power is 10, $n_1 = 31.3$; hence the effective moment of inertia added by the indicator, $n_1^2 I_3'$ equals 27.5×10^4 , or $\frac{1}{225}$ th of $I_{(3)}$.

Let us write $I_{(3)} + n_1^2 I_{(3)'} + n_1^2 n_2^2 I_{(3)''} \dots = [I]$; also $[I]/Ml = L$; introducing these substitutions in the equation (23) we get

$$\frac{d^2\theta}{dt^2} - \frac{1}{L} \frac{d^2\xi}{dt^2} + \frac{gi}{L} \left(\frac{\omega_y}{i} + \theta \right) = 0 \quad (24)$$

We have so far not taken account of friction; but all instruments are subjected both to viscous friction, or damping, proportional and opposite to the velocity, and to solid friction, which has a constant quantitative value, but always opposes the motion; in some cases, special devices are added to increase the damping. Writing $2\kappa d\theta/dt$ to represent the damping and $\mp p_0$ for the solid friction, the equation becomes

$$\frac{d^2\theta}{dt^2} + 2\kappa \frac{d\theta}{dt} - \frac{1}{L} \frac{d^2\xi}{dt^2} + \frac{gi}{L} \left(\frac{\omega_y}{i} + \theta \right) \mp p_0 = 0 \quad (25)$$

We here assume that the damping is proportional to the velocity relative to the support. This is true where special damping devices are affixed to the support, but in the case

where no special damping is introduced, the viscous friction is largely due to the resistance of the surrounding air, and if this does not move with the support, it will not be proportional to the *relative* velocity, but to some complicated function of the relative and absolute velocities. If the instrument is in a closed room, and the earthquake motion not fast, the air will, to some extent, move with the support, and as the damping, when special devices are not used, is extremely small, we make no material error in putting it proportional to the *relative* velocity.

θ in the equation refers to the relative angular displacement of the pendulum; if we prefer to deal directly with the relative displacement of the marking point, we can proceed as follows: let \bar{l} be the length of the long arm of the last or marking lever, and $\bar{\theta}$ its angular displacement; multiply the equation (25) throughout by $\bar{n}\bar{l}$, where $\bar{n} = n_1 n_2 n_3 \dots$. If a is the linear relative displacement of the marking point $a = \bar{l}\bar{\theta} = \bar{n}\bar{l}\theta$; making these substitutes in the equation it becomes

$$\frac{d^2 a}{dt^2} + 2\kappa \frac{da}{dt} - \frac{\bar{n}\bar{l}}{L} \frac{d^2 \xi}{dt^2} + \frac{g\bar{i}}{L} \left(\frac{\bar{n}\bar{l}\omega_0}{i} + a \right) \mp p' = 0 \quad (26)$$

where $p' = \bar{n}\bar{l}p_0$. a and its derivatives in this equation will have positive or negative signs, according as the number of multiplying levers is odd or even; this will be evident if we suppose the support to have an acceleration in the positive direction; the pendulum will be left behind; and the long end of the first lever will move in the positive direction, that of the second lever in the negative direction, etc. These are the equations of relative motion of the pendulum and of the marking point, and they are the only equations we have from which to deduce the movement of the support. It will be seen that, for the horizontal pendulum with the origin at the CG_0 and to the degree of approximation used, the only displacements of the support which enter are the linear acceleration parallel to the axis of x , and the rotation around the axis of y ; but as both enter the equation we are not able to determine the value of either separately. (See, however, page 188.)

For the Milne instrument direct photographic registration is used; if l_1 is the length of the beam from the axis of rotation to the slit for the recording light, then $a = -l_1\theta$, since $l_1\theta$ and a are positive in opposite directions; and in equation (26) $-\bar{n}\bar{l}$ must be replaced by l_1 . For the von Rebeur-Paschwitz form the optical method of registration is used; if D is the distance from the mirror on the pendulum to the recording paper, then $a = -2D\theta$ and $\bar{n}\bar{l}$ must be replaced by $-2D$.

We see from the equation that 2 pendulums which have the same values of κ , L , i , and p_0 have identical equations, and their movements for the same disturbance would be identical, although they might differ very much in mass and in form; and *vice versa*, in order that 2 pendulums should have identical motions for the same disturbance it is necessary that the constants above should have the same values for the 2 pendulums. This makes it perfectly clear why 2 dissimilar pendulums give such different records of the same disturbance; indeed 2 pendulums made as nearly alike as possible give dissimilar records if they have different values of i , *i.e.* different periods; or even if they have different values of p' . This was pointed out in 1899 by Dr. O. Hecker.¹ Two horizontal pendulums of the von Rebeur-Paschwitz type made as nearly alike as possible, mounted side by side, and having the same period of vibration, gave very different records of the same earthquake. The difference was found to be due to differences in the friction at the supporting points. Alterations were made until the friction was the same in the two instruments as shown by the similarity of the dying-out curves of free vibrations. After that the two instruments gave similar records of a disturbance.

¹ Zeit. für Instrumentenkunde, 1899, p. 266.

In order to determine the value of linear displacements, we must either neglect the rotation as small, or determine its value as a function of the time from some other instrument; and then either integrate the equation, which can be done if it is found by the record to be a simple form, say a simple harmonic curve; or we must laboriously measure from the record the successive values of $d^2\theta/dt^2$, $d\theta/dt$ and θ , which when introduced into the equation will give us the successive values of $d^2\xi/dt^2$. A double summation of these values will then give us the successive values of the displacement ξ . So far as I know this process has only been carried out once and then without taking into consideration the constant p .¹ The process is very laborious and emphasizes the advantage which some other form of instrument would have, in which the relation between its displacement and that of the earth would be more direct and simple.

DETERMINATION OF THE CONSTANTS.

But with the instruments we now have, it is important to determine the values of these constants, which can be done as follows. If the support were subjected to a very rapid but small movement, the second derivatives would be so much larger than the other terms in the equations (25) and (26), that the latter could be neglected and we should have

$$L \frac{d^2\theta}{dt^2} = \frac{d^2\xi}{dt^2} \qquad \frac{d^2a}{dt^2} = \frac{\bar{nl}}{L} \frac{d^2\xi}{dt^2} \qquad (27)$$

Integrating and neglecting the velocity multiplied by the time of the movement, as the latter is supposed extremely short, we get

$$L(\theta - \theta_0) = \xi - \xi_0 \qquad a - a_0 = \frac{\bar{nl}}{L}(\xi - \xi_0) \qquad (28)$$

This shows that for a movement of this kind a point on the pendulum distant L from the axis of rotation will have a relative displacement equal, but in the opposite direction, to that of the support; that is, that it will actually not be displaced by the movement. This point is the center of oscillation. It is also the point at which the whole mass of the pendulum might be concentrated without affecting its motions; L is therefore called the length of the mathematical pendulum of the *same type*; such a mathematical pendulum would have the same period as the actual pendulum (as we shall see later), but we must remember that L , as defined here, is not the length of a simple pendulum having the same period as the horizontal pendulum.

We also see from the second equation that the actual movement of the marking point will be \bar{nl}/L times as great as that of the support; this then will represent the magnifying power for small rapid linear displacements, and we may represent it by V . Its value is evidently

$$V = \frac{l_1}{L} \cdot \frac{l_2'}{l_2} \cdot \frac{l_3'}{l_3} \cdot \dots \cdot \frac{\bar{l}}{l_n} = \frac{\bar{nl}}{L}, \text{ or } = \frac{\bar{ml}_1}{L} \qquad (29)$$

if we write $\bar{m} = m_1 m_2 m_3 \cdot \dots$ where $m_1 = l_2'/l_2 \cdot \dots$ etc., i.e., m_1 equals the ratio of the long to the short arm of the first lever, etc. If on the other hand there is no linear dis-

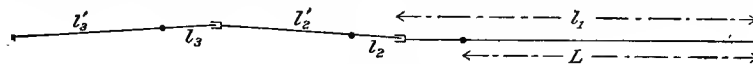

FIG. 39.

placement, but a small rapid angular acceleration around the axis of y , the pendulum is not affected at all; for the equation does not contain the angular acceleration. This

¹ By General H. Pomerantzeff, Recherches concernant le sismogramme tracé à Strassbourg le 24 Juin, 1901. Acad. Imp. Sci. St. Petersburg; C. R. Com. Sism. Perm., 1902, Liv. 1, pp. 185-208.

arises from the fact that we have taken our origin of coördinates at the CG_0 of the pendulum.

If we go back to the equation (18) and eliminate the reaction of the indicator as before, but retain the term containing the angular acceleration about axis (3), we should find in our final equation the terms

$$(I_{(3)} + n_1^2 I_{(3)'}) d^2\theta/dt^2 + (I_3 + I_3') d^2\omega_3/dt^2$$

which would be the only important terms in our equation, when a very small but very rapid angular acceleration occurred around axis (3). Integrating, we find

$$\theta - \theta_0 = - \frac{(I_3 + I_3')}{I_{(3)} + n_1^2 I_3'} (\omega_3 - \omega_{3,0}) \quad (30)$$

For the Bosch-Omori pendulum $I_{(3)}$ is about 30 times I_3 ; $n_1^2 I_3'$ and I_3' are negligible; we therefore see that the angular displacement of the pendulum would only be about $\frac{1}{30}$ of that of the support around the axis (3).

If, on the other hand, there is a permanent angular displacement about the axis of y , and no other disturbance, we must have for equilibrium $\theta = a/\overline{nl} = -\omega_y/i$; we have neglected the solid friction, which may act to increase or decrease the angle θ , or the displacement a , according as the pendulum reaches its position of equilibrium from one side or the other. We shall see later how the value of p' affects the result, but neglecting it for the moment, we see that the angular displacement of the pendulum is $1/i$ times that of the support. Hence $1/i$ may be taken as the magnification of constant angular displacements around axis of y . For the Bosch-Omori instrument this is about 70, for the Milne, about 450, and for the von Rebeur-Paschwitz, about 700, when the period of vibration is about 17 seconds. As appears below, $1/i$ is proportional to T_0^2 .

If there is no disturbance and we neglect friction, equation (26) reduces to the form

$$\frac{d^2a}{dt^2} + \frac{gi}{L} a = 0 \quad (31)$$

whose solution represents a simple harmonic swinging of the pendulum with a period

$$T_0 = 2\pi \sqrt{\frac{L}{gi}} \quad (32)$$

Therefore in equations (25) and (26), gi/L can be replaced by $(2\pi/T_0)^2$; T_0 can readily be determined by observation. $L' = L/i$ is the length of a simple mathematical pendulum having the same period as the instrument under consideration.

Equation (26) may now be written

$$\frac{d^2a}{dt^2} + 2\kappa \frac{da}{dt} + \frac{ga}{L'} - V \frac{d^2\xi}{dt^2} + Vg\omega_y \mp p' = 0 \quad (26a)$$

It contains four constants, and when these are known the characteristics of the instrument are known. Two instruments, however they may differ in mass, size, shape, and even in type, as we shall see later, will give identical records of the same disturbance if these constants are respectively equal for the two instruments.

We have seen that L' can very easily be determined through equation (32) by determining the period of vibration. V can be found by measuring the various quantities which define it in equation (29). Instead of measuring the value of L it can be found from L' through the relation $L = iL'$, after i has been found by one of the methods given below.

¹ If we use the displacement of the pointer to measure the rotation we have $\omega_y = ia/VL$.

There is a direct experimental method of determining V due to Professor Wiechert.¹ Displace the pendulum by applying a small force f at right angles to it and at a distance l' from the axis of rotation. Its moment will be fl' . The equal moment of restitution exerted by the pendulum will be $Mlgi\theta$, where θ is the angular displacement of the pendulum; this appears immediately from the theory of vibrating bodies if we replace L in equation (32) by its value $[I]/Ml$.

Equating these two moments we find $i\theta = fl'/Mlg$. If the marking point at the same time has been displaced a distance a_1 , then

$$V = \bar{m}\theta/L\theta = a_1/L\theta = a_1/L'i\theta \quad (33)$$

a_1 is observed, L' determined through the period of vibration, and $i\theta$ calculated by the moment of the applied force, as above.

In applying the force Professor Wiechert uses what is practically the beam of a balance with a vertical pointer; the latter presses against the pendulum with a force due to a weight placed at the end of the beam. If the length of the pointer is half the length of the beam, then a weight mg placed on the end of the beam will exert a pressure mg against the pendulum; and we find $i\theta = ml'/Ml$.

Equation (32) also enables us to determine the value of i , which can not be measured directly with any degree of accuracy; L can be determined by measuring the quantities entering its definition (p. 155); g is supposed known and i can then be calculated. A special arrangement by which the von Rebeur-Paschwitz pendulum can be swung with its axis of rotation horizontal enables us to determine its i and L with ease. When i is large it must be replaced in the equation (32) by the accurate term $\sin i$; when i is 90° this becomes unity, and we get for the period

$$T_v = 2\pi\sqrt{\frac{L}{g}}$$

from which L can be immediately calculated. When the pendulum is hung so that i is small, the period is given by equation (32), hence

$$i = T_v^2/T_0^2 \quad (34)$$

We have seen that if we tilt the support through an angle ω_y the pendulum is displaced through an angle $\theta = -\omega_y/i$. It is easy to produce a known tilt on a Milne instrument by means of the leveling screws, and on the Bosch-Omori instrument by means of the horizontal adjusting screw at the top of the supporting column. The value of i can then be calculated by measuring θ directly, or by calculating it through the displacement a_1 of the pointer; for, $VL = a_1/\theta = \bar{m}l_1$; and \bar{m} and l_1 are very easily measured.

Returning again to equation (26), neglecting the solid friction and supposing no disturbance, the equation becomes

$$\frac{d^2a}{dt^2} + 2\kappa\frac{da}{dt} + \left(\frac{2\pi}{T_0}\right)^2 a = 0 \quad (35)$$

of which the solution is

$$a = a_0 e^{-\kappa t} \sin \frac{2\pi}{T} (t - t_0) \quad (36)$$

provided $2\pi/T_0$ is greater than κ . a_0 and t_0 are constants to be determined by the initial conditions and T is given by

$$\left(\frac{2\pi}{T}\right)^2 = \left(\frac{2\pi}{T_0}\right)^2 - \kappa^2 \quad (37)$$

¹ Beiträge zur Geophysik, vol. VI, p. 446.

also
$$\frac{g_i}{L} = \left(\frac{2\pi}{T_0}\right)^2 = \left(\frac{2\pi}{T}\right)^2 + \kappa^2 = \left(\frac{2\pi}{T}\right)^2 \left\{1 + \left(\frac{\kappa T}{2\pi}\right)^2\right\} \quad (38)$$

$$\therefore T_0 = T / \sqrt{1 + (\kappa T / 2\pi)^2} \quad (38a)$$

If κ is small, we can deduce

$$T_0 = T \left\{1 - \frac{1}{2} \left(\frac{\kappa T}{2\pi}\right)^2\right\} \quad (39)$$

If, as in the majority of pendulums now in use, there is no especial device for damping, κ is a very small quantity and we may, to a close degree of approximation, write $T = T_0$ and $2\pi/T = 2\pi/T_0$.

The solution, equation (36), represents a simple harmonic motion with decreasing amplitude given by $a_0 e^{-\kappa t}$; to determine the successive maximum swings in opposite sides of the central line, we put $t = 0, T/2, 2T/2, \text{etc.}$, in the expression. The ratio of these successive values of the amplitude is constant and equals $e^{\kappa T/2}$; *i.e.*, if $a_0, a_1, a_2, \text{etc.}$, are the successive maximum displacements we have

$$\frac{a_0}{a_1} = \frac{a_1}{a_2} = \frac{a_2}{a_3} \dots = e^{\kappa T/2} = \epsilon \quad (40)$$

this quantity is called the *damping ratio*. To determine the value of κ , take the natural logarithms of both sides of equation (40); we get

$$\log_e \frac{a_0}{a_1} = 2.3026 \log \frac{a_0}{a_1} = \frac{\kappa T}{2} = \Delta \quad (41)$$

where \log stands for the logarithm to the base 10. Δ is called the logarithmic decrement of the amplitude. From this equation we can calculate κ , but as it is difficult to get a good determination of the ratio of two successive amplitudes, we can determine κ from the ratio of the zeroth to the n th amplitude, as follows: Multiply together the successive ratios of equation (40) and we get

$$\frac{a_0}{a_n} = e^{n\kappa T/2} = \epsilon^n \quad (42)$$

take logarithms of both sides of the equation, and we get

$$\frac{1}{n} \log_e \frac{a_0}{a_n} = \frac{2.3026}{n} \log \frac{a_0}{a_n} = \frac{\kappa T}{2} = \Delta \quad (43)$$

This gives us more accurate values of κ and Δ . The quantity needed to determine T_0 in equation (39) is $\kappa T / 2\pi$, and this becomes

$$\frac{\kappa T}{2\pi} = \frac{2.3026}{n\pi} \log \frac{a_0}{a_n} = \frac{0.733}{n} \log \frac{a_0}{a_n} = \frac{\Delta}{\pi} \quad (44)$$

In determining κ or $\kappa T / 2\pi$, one naturally observes a_0 and a_n ; but the logarithmic decrement, Δ , is a recognized constant, and is the quantity usually recorded to indicate the damping of the instrument. It is to be noticed that the logarithmic decrement is not a constant, but is proportional to the damped period.

We also have from equation (38)

$$\left(\frac{\kappa T_0}{2\pi}\right)^2 = \left(\frac{\kappa T}{2\pi}\right)^2 / \left\{1 + \left(\frac{\kappa T}{2\pi}\right)^2\right\} \quad (44a)$$

and through equations (40) and (41)

$$\left(\frac{\kappa T_0}{2\pi}\right)^2 = \frac{\log_e^2 \epsilon}{\pi^2 + \log_e^2 \epsilon} = \frac{\log^2 \epsilon}{1.862 + \log^2 \epsilon} \quad (44b)$$

The use of this formula is the quickest means of calculating the value of $\kappa T_0/2\pi$, which enters the expression for the magnifying power of the seismograph for harmonic vibrations.

The vibrations of the pendulum under damping lie between two exponential curves, $e^{-\kappa t}$ and $-e^{-\kappa t}$ as shown in figure 40.

There are few instruments free of all solid friction; this enters at the pivots and at the marking point. At the pivot it is merely a constant moment tending to stop the

motion; but it may have a somewhat different value for motion in opposite direction. At the marking point the effect is different; in figure 41, let a be the pivot, and b the marking point of the indicator; let the recording paper be moving to the right with a velocity of v'' ; let the marking point be moving to reduce θ' with a velocity v' ; bc and bd , as shown in the figure, will indicate the movements of the marking point relative to the paper, as the result of these movements respectively; the resultant relative motion will be be , and the frictional force

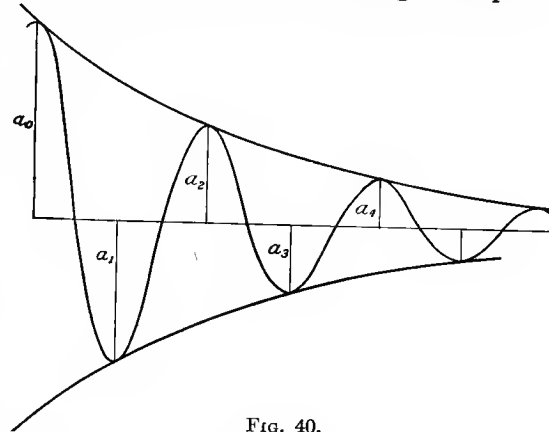

FIG. 40.

which will be directed in the direction opposite to be may be represented by a constant ϕ . Let α be the angle which its direction makes with the direction of motion of the paper, and let θ' be the angular displacement of the lever from the same direction (which should be its direction of equilibrium).

We may divide ϕ into two components, one in the direction of the lever, which is resisted by a reaction at the pivot and does not tend to rotate the lever; a second at

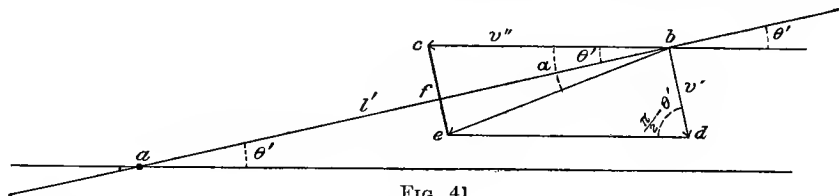

FIG. 41.

right angles to the lever, which exercises a moment to turn it; to determine this moment we must get the component of ϕ in the direction of v' and multiply it by l' . This effective moment is

$$-\phi l' \sin(\alpha - \theta') = -\frac{\phi l' e f}{be} = -\phi l' \frac{v' - v'' \sin \theta'}{\sqrt{v'^2 + v''^2 - 2v'v'' \sin \theta'}} \quad (45)$$

This can be developed in powers of v'/v'' (which we will write v_{11}') or of v''/v' (or v_1'') whichever is less than unity, and we get

$$\phi l' (1 - v_1'' \sin \theta') (1 - v_{11}'^2/2 + v_{11}' \sin \theta' + \dots)$$

or

$$\phi l' (v_{11}' - \sin \theta') (1 - v_{11}'^2/2 + v_{11}' \sin \theta' + \dots) \quad (46)$$

If the lever is moving very rapidly in comparison with the paper, v_1'' becomes a small quantity, it may be neglected, and the first expression becomes $\phi l'$, that is, there is a constant moment tending to stop the motion of the pendulum. If the paper is moving very rapidly in comparison with the lever, v_{11}' is a small quantity, and the second expression reduces to $\phi l' (v_{11}' - \sin \theta' - v_{11}' \sin^2 \theta' + \dots)$; which, when θ' is small,

become $\phi l'(v_{11}' - \theta')$; this represents a moment proportional to the velocity of the lever, and a second proportional to the displacement.

In the intermediate case where neither v' nor v'' is preponderatingly large, the frictional moment is a complex function of their ratio and of the angular displacement. In any large swing the recording point may pass thru its position of equilibrium with a velocity much larger than that of the paper, but as it reaches the limit of its swing its velocity gradually reduces to zero; hence the nature of the moment brought into play varies materially during the swing. As the lever passes its zero position the friction exercises a constant moment; and as it approaches the maximum displacement the friction exercises a damping moment, and a force of restitution.

It sometimes happens, on account of a slight tilting of the pier, that the pendulum's equilibrium position is not exactly in a line with the pivot of the indicator lever, so that

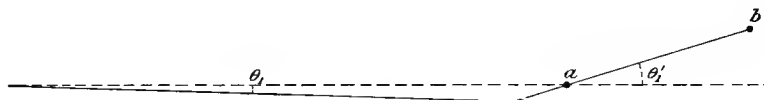

FIG. 42.

the lever stands at an angle with the pendulum. The frictional moment has the same expression as we have already found except that we must replace θ' by $\theta' + \theta_1'$, where θ_1' is the angular displacement of the indicator when the pendulum is at rest, and θ' the displacement from this position during a disturbance. The limiting cases (as on p. 161) become $\phi l'$ and $\phi l'(v_{11}' - \theta' - \theta_1')$ if θ' and θ_1' are not large; that is, in the second case, we must add to the moments already considered another moment which tends to bring the pendulum back to the proper position of equilibrium.

Let us see what is the nature of the frictional moment in a special case; let us suppose we have a simple harmonic swing of the marking point of period, $P = 15$ secs., and amplitude 4 cm.; let the velocity of the paper be 1.5 cm. per minute, or $v'' = 0.025$ cm. per second. We have supposed the swing simple harmonic, which it would not be under the action of the friction, but it would be approximately so, and we can get a fair idea of the variation of the frictional moment under this supposition. If y is the displacement, we shall have

$$y = a \sin \frac{2\pi}{P} t; \quad v' = \frac{dy}{dt} = \frac{2\pi a}{P} \cos \frac{2\pi}{P} t$$

then $2\pi a/P = 25/15 = 1.67$, and putting the successive values of the sine in the general equation for the frictional moment (45), we find that the force does not vary much for something over an eighth of the period on each side as the pointer crosses the zero position, and it changes very quickly near the ends of the swings; for movements therefore in which the maximum value of v'/v'' is of the order of $1.67/0.025 = 67$, the frictional moment does not vary much in value during a large part of the swing. It would produce a much too complicated expression to introduce the actual value of the frictional moment into the equation of the pendulum; the best we can do is to look upon it as made up of a damping moment, which would enter the general damping term, a moment proportional to the displacement, which would combine with a similar term in the equation, and of a constant moment opposed to the motion, which would be represented, together with pivotal friction, by the constant term of the equation. The importance of reducing all this friction to a minimum is evident, for we can not take accurate account of it. Hence the adoption of very heavy pendulums, which reduce the effect of the frictional forces on their motion. That the friction at the recording point is, in general, very important, is shown by the rapid dying out of the vibrations of a Bosch-Omori

pendulum when the pointer is marking, in comparison to the very slow dying down when the marking point does not touch the smoked paper. The effect of the multiplying levers in increasing the influence of the friction can easily be found. Using the same notation as on pages 151, 155, we have

$$f_1 l_2 = f_2 l_2'; \quad f_2 l_3 = f_3 l_3'; \quad \text{etc.}$$

where for this particular case, the f 's represent the reaction between the levers brought about by the friction ϕ , of the marking point only, and the inertia of the levers is not considered.

This gives

$$f_1 l_1 = f_2 \frac{l_1 l_2'}{l_2} = \dots = \phi \frac{l_1 l_2' l_3' \dots l_n}{l_2 l_3 l_4 \dots l_n} = \phi \bar{n} l = \phi \bar{m} l_1 \quad (47)$$

that is, the frictional moment is proportional to the multiplying power of the levers.

Assuming that the friction adds a damping moment, a moment proportional to the displacement, and a constant moment, opposing the motion of the pendulum, we have still to determine in our general equation (26) the values of the constants κ and p' . If in this equation we replace a by $a' \mp Lp'/gi$, it becomes

$$\frac{d^2 a'}{dt^2} + 2\kappa \frac{da'}{dt} - \frac{\bar{n}l}{L} \frac{d^2 \xi}{dt^2} + \frac{gi}{L} \left(\frac{\bar{n}l}{i} \omega_y + a' \right) = 0 \quad (48)$$

the form is unchanged except that the constant term drops out. Therefore the vibration of a pendulum, affected by constant friction, has the same period and is otherwise the same as that of a pendulum without the friction, except that the vibration no longer takes place about the medial line, but about a line displaced from it by an amount Lp'/gi , and this displacement is first on one side of the medial line and then on the other. We may therefore look upon the force of restitution, not as proportional to a , the displacement, but to a less Lp'/gi ; and the pendulum can remain at rest anywhere between the two displaced medial lines. Let us call the distance between the true medial line and its displaced position, the "frictional displacement of the medial line," and denote its value, Lp'/gi or $p'(T_0/2\pi)^2$, by r . It must be determined by experiment. We have just seen that the frictional moment exerted on the pendulum is proportional to the multiplying power of the levers, therefore the frictional displacement of the point l_1 is proportional to the same quantity; and the frictional displacement of the marking point is \bar{m}^2 times as great, or proportional to the square of the multiplying power. Suppose the frictional displacement of the marking point at l_1 were 0.01 mm., that at the end of one lever multiplying 10 times would be 1 mm.; and at the end of a second similar lever, 100 mm. We can determine the relation between p' , r and ϕ ; the frictional force ϕ exerted at the marking point equals a force $\bar{m}\phi$ exerted at the point of contact, l_1 , of the pendulum and the first lever, and this exerts a moment $\phi \bar{m} l_1$, and therefore produces an acceleration of the pendulum equal to $\phi \bar{m} l_1 / [I]$; this acceleration is represented by p_0 in equation (25). Hence

$$p' = \left(\frac{2\pi}{T_0} \right)^2 r = \bar{n} l p_0 = \frac{\phi \bar{m} l_1 \bar{n} l}{[I]} = \frac{\phi \bar{m}^2 l_1^2}{[I]} \quad (48a)$$

In figure 43, let a_0, a_1, a_2 , etc., be the successive excursions measured from the medial line; let r be the displacement of the medial line; then if there is no damping and the pendulum starts from a displacement a_0 , that is $a_0 - r$ from the displaced line, it will swing an equal distance to the other side of this line, or $a_0 - r = a_1 + r$; $\therefore a_1 = a_0 - 2r$; as it starts back from a_1 the medial line is suddenly displaced to (2), and $a_1 - r = a_2 + r$;

$\therefore a_2 = a_1 - 2r$; and we see that each successive excursion of the pendulum is diminished by $2r$. When at last the friction stops the motion between the lines (1) and (2), the point

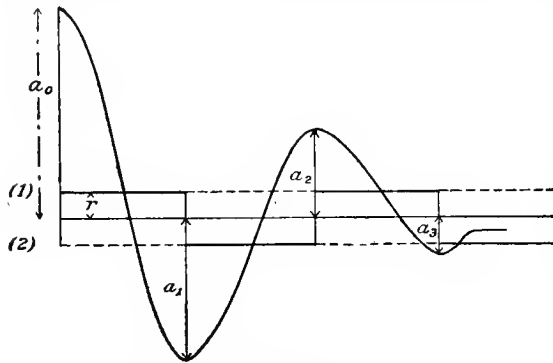

FIG. 43.

will cease to vibrate, the friction being just enough to hold it in the position where it stops. But when the vibration becomes very small, the friction no longer exerts a constant force, but a damping force and a force of restitution, and therefore the marking point would continue to approach the true medial line, being kept from it only by the constant friction of the pivots.

When there is damping, the successive excursions about the displaced lines are not equal, but they gradually diminish in the ratio $e^{-\kappa T/2}$, which we have called ϵ ; we have therefore

$$\frac{a_0 - r}{a_1 + r} = \frac{a_1 - r}{a_2 + r} = \dots = \epsilon \tag{49}$$

and it is from this series of equations that we must determine κ and p' . As the position of the medial line may be unknown, we can not measure the a 's, so we must proceed as follows: adding numerators and denominators of the equal fractions we get

$$\frac{a_1 + a_2 - 2r}{a_2 + a_3 + 2r} = \epsilon \quad \text{or} \quad \frac{A_1 - 2r}{A_2 + 2r} = \frac{A_2 - 2r}{A_3 + 2r} = \dots = \epsilon \tag{50}$$

where $A_1 = a_1 + a_2$, $A_2 = a_2 + a_3$, etc., the A 's are the ranges of the vibrations, that is, the distances from a maximum excursion on one side to the next on the other. Subtracting the numerators and denominators, the second from the first, the third from the second, etc., we find

$$\frac{A_1 - A_2}{A_2 - A_3} = \frac{A_2 - A_3}{A_3 - A_4} = \dots = \epsilon \tag{51}$$

Solving the first equation (50) for $2r$ and introducing the value of ϵ from the first equation (51), we get

$$2r = \frac{A_2^2 - A_1 A_2}{A_1 - A_3} \tag{52}$$

Equations (51) and (52) enable us to determine the values of ϵ and r from the measure of three successive ranges; these equations are suitable when the ranges diminish rapidly in value; but when they diminish very slowly, these equations will not yield accurate values, and we must deduce others containing ranges which are sufficiently far apart to have materially different values. We proceed as follows: add the numerators and the denominators of equations (51) and we get

$$\frac{A_1 - A_m}{A_2 - A_{m+1}} = \frac{A_2 - A_{m+1}}{A_3 - A_{m+2}} = \dots = \epsilon \tag{53}$$

multiplying n of these fractions together, we get

$$\frac{A_1 - A_m}{A_{n+1} - A_{n+m}} = \epsilon^n$$

m and n may be any numbers we please; let us take $m = n + 1$, and the formula becomes

$$\frac{A_1 - A_{n+1}}{A_{n+1} - A_{2n+1}} = \epsilon^n = e^{n\kappa T/2} \tag{54}$$

From this we deduce as before

$$\frac{\kappa T}{2\pi} = \frac{0.733}{n} \log_{10} \frac{A_1 - A_{n+1}}{A_{n+1} - A_{2n+1}} \quad (55) \quad \kappa = \frac{4.605}{nT} \log_{10} \frac{A_1 - A_{n+1}}{A_{n+1} - A_{2n+1}} \quad (56)$$

Solving equation (50) for $2r$, we get

$$\begin{aligned} 2r &= \frac{A_1 - \epsilon A_2}{1 + \epsilon} = \frac{A_2 - \epsilon A_3}{1 + \epsilon} = \dots \text{ etc.} \\ &= \frac{A_1 - \epsilon A_2}{1 + \epsilon} = \frac{\epsilon A_2 - \epsilon^2 A_3}{\epsilon(1 + \epsilon)} = \dots \text{ etc.} \end{aligned}$$

adding numerators and denominators

$$2r = \frac{A_1 - \epsilon^n A_{n+1}}{(1 + \epsilon)(1 - \epsilon^n)/(1 - \epsilon)} = \frac{\epsilon - 1}{\epsilon + 1} \frac{A_1 - \epsilon^n A_{n+1}}{\epsilon^n - 1}$$

replacing value of ϵ^n from equation (54) we get

$$2r = \frac{\epsilon - 1}{\epsilon + 1} \frac{A_{n+1}^2 - A_1 A_{2n+1}}{(A_1 - A_{n+1}) - (A_{n+1} - A_{2n+1})} \quad (57)$$

Equations (55), (56) and (57) are perfectly general; and n may be given any integral value greater than 0. The factor $(\epsilon - 1)$ in equation (57) reduces the accuracy in the determination of r when ϵ is nearly equal to 1; but ϵ can be determined with considerable accuracy from equation (54) if we have a good record of free vibrations without outside disturbance. r being thus determined, we can find p' and ϕ from equation (48a). Thus the damping and frictional constants can be determined from the measure of 3 ranges.

Returning now to equation (35), let us consider the case where the friction is so great that the movement is no longer periodic so that we can not determine κ and p' by the above methods. We shall then have $\kappa > 2\pi/T_0$, and the solution of the equation (35) under this condition is

$$a = A_1 e^{-m_1 t} + A_2 e^{-m_2 t} \quad (58)$$

where

$$m_1 = \kappa + \sqrt{\kappa^2 - n^2}, \quad m_2 = \kappa - \sqrt{\kappa^2 - n^2} \quad (59)$$

and n is written for $2\pi/T_0$; A_1 and A_2 are arbitrary constants whose values are to be determined to correspond to the special conditions imposed. Neglecting solid friction for the present, we can determine the value of κ by displacing the pendulum an amount a_0 and then setting it free; that is, at time t_0 we have $a = a_0$ and $da/dt = 0$. If we determine A_1 and A_2 to satisfy these conditions, equation (58) becomes

$$a = \frac{a_0}{m_1 - m_2} (m_1 e^{-m_2 t} - m_2 e^{-m_1 t}) \quad (60)$$

This represents the difference of two exponential curves, and since m_1 is greater than m_2 , the second term in the parenthesis is always smaller than the first and a is always positive; and therefore the pendulum remains on the positive side of the position of equilibrium, gradually approaching it, but only reaching it when t is ∞ .

To determine κ we must first determine n or $2\pi/T_0$. To do this, reduce the value of κ sufficiently to allow a satisfactory periodic motion, and determine the period. Increase the value of κ until the motion is aperiodic. Now displace the pendulum an amount a_0 and release it exactly at the beat of a seconds pendulum; determine the deflection from its position of equilibrium at, say, every 5 or 10 beats of the pendulum. On substituting the values of a_0 , n , and t in equation (60) we can determine κ by trial, each observation giving a value of κ ; the average can then be taken. It would be very difficult to deter-

mine κ using the ordinary method of recording; a much better way would be to attach a small mirror to the pendulum and read the deflections with a telescope and scale in the ordinary method used for delicate galvanometers. If electro-magnetic damping is used, it is easy to vary the damping, but with mechanical methods it is much more difficult.

In the particular case when $\kappa = 2\pi/T_0$ the solution of equation (35) becomes

$$a = e^{-\kappa t} (A_1 + A_2 t) \quad (61)$$

If the pendulum were displaced a distance a_0 and released at time $t = 0$, the arbitrary constants A_1 and A_2 take such values that the equation becomes

$$a = a_0 e^{-\kappa t} (1 + \kappa t) \quad (62)$$

and the pendulum approaches its position of equilibrium rapidly at first but only reaches it after an infinite time. If we have control over the damping factor, we can attain this condition by starting with a damped periodic vibration and then increasing the value of κ until the pendulum no longer crosses its equilibrium position, when displaced and released; the value of κ would then be $2\pi/T_0$.

A second method to determine κ is to start the pendulum into sudden motion by a smart blow delivered at the center of oscillation and then determine the time for it to attain its greatest displacement. Equation (58) becomes under these conditions

$$a = \frac{v_0}{m_1 - m_2} (e^{-m_2 t} - e^{-m_1 t}) \quad (63)$$

where v_0 is the initial velocity. If we put da/dt equal to zero, we find that the time of greatest displacement, t_1 , is given by

$$(m_1 - m_2)t_1 = \log_e \frac{m_1}{m_2} = 0.4343 \log_{10} \frac{m_1}{m_2} \quad (64)$$

Under similar conditions, equation (61) becomes

$$a = v_0 t e^{-\kappa t} \quad (65)$$

and the time of greatest displacement is given by

$$t_1 = \frac{1}{\kappa} \quad (66)$$

The effect of solid friction is merely to shift the position of equilibrium; this, however, is only strictly true provided p' is truly constant; but we have seen that this is not the case when the movement of the pendulum is slow in comparison with that of the drum, as it would be during a large part of the motion in the case under consideration. Prince Galitzin is the only person so far who has used such excessive damping, and he has used optical registration so that the friction of the marking point is absent. If mechanical registration were to be used with a so strongly damped instrument, a careful experimental study should be made of its effect, as we can not say that we know how to allow for it at present.

INTERPRETATION OF THE RECORD.

We have seen how to find the values of the constants which enter the equation of the horizontal pendulum, so that we can apply the equation to a given record and find the corresponding movement of the support. To do this we must integrate the equation;

that is, we must substitute for a , da/dt , and d^2a/dt^2 , their values as given by the record, and we can then calculate $d^2\xi/dt^2$. If, as is generally the case, the record is not a simple regular curve, we must determine the values of a and those of its derivatives for points of the curve at very small intervals and then integrate the resulting values of $d^2\xi/dt^2$, graphically or otherwise. This process is very long. If, on the other hand, the record is a simple harmonic curve, and it frequently approximates this for short times, we can integrate the equation directly. Equation (26) becomes, after substituting the values of the coefficients,

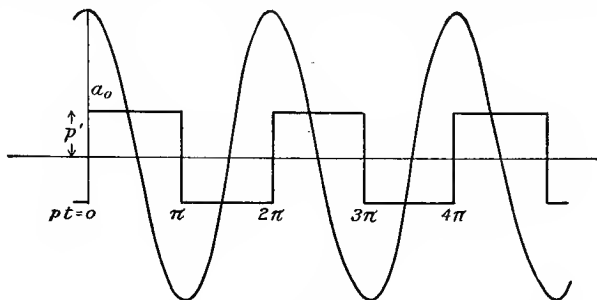

FIG. 44.

$$\frac{d^2a}{dt^2} + 2\kappa \frac{da}{dt} + n^2a - V \frac{d^2\xi}{dt^2} + Vg\omega_y \mp p' = 0 \quad (67)$$

where we have put n^2 for gi/L , or $(2\pi/T_0)^2$, by equation (32).

Let us suppose first that there is no rotation, and the term $Vg\omega_y$ disappears. Choosing the origin of time when the pendulum has its greatest elongation in the positive direction, we can write

$$a = a_0 \cos(2\pi/P)t = a_0 \cos pt \quad (68)$$

$$da/dt = -pa_0 \sin pt; \quad da^2/dt^2 = -p^2a_0 \cos pt \quad (69)$$

p' is a discontinuous function, having a constant numerical value, but suddenly changing sign with the velocity which it always opposes. We can represent it by the series

$$p' = \frac{4n^2r}{\pi} (\sin pt + \frac{1}{3} \sin 3pt + \frac{1}{5} \sin 5pt \dots) \quad (70)$$

where n^2r , or $(2\pi/T_0)^2r$, as in equation (48a), is the positive numerical value of p' ; this series represents the broken line in figure 44 for all values of t . Substituting the above values in the equation of the pendulum, it reduces to

$$V \frac{d^2\xi}{dt^2} = A \cos(pt - \chi) - \frac{4n^2r}{\pi} (\sin pt + \frac{1}{3} \sin 3pt + \dots) \quad (71)$$

where

$$A \cos \chi = a_0(n^2 - p^2); \quad A \sin \chi = -2\kappa p a_0 \quad A^2 = a_0^2 \{ (n^2 - p^2)^2 + (2\kappa p)^2 \} \quad (72)$$

Multiplying by dt and integrating from $t=0$ to $t=t$, we get

$$V \frac{d\xi}{dt} - V \left(\frac{d\xi}{dt} \right)_0 = \frac{A}{p} \sin(pt - \chi) + \frac{A}{p} \sin \chi + \frac{4n^2r}{\pi p} \left(\cos pt + \frac{1}{3^2} \cos 3pt \dots \right) - \frac{4n^2r}{\pi p} \left(1 + \frac{1}{3^2} + \frac{1}{5^2} \dots \right) \quad (73)$$

Integrating again, after replacing the last series by its value, $\pi^2/8$, we get

$$V\xi - V\xi_0 - V \left(\frac{d\xi}{dt} \right)_0 t = -\frac{A}{p^2} \cos(pt - \chi) + \frac{A}{p^2} \cos \chi + \frac{A}{p} \sin \chi \cdot t + \frac{4n^2r}{\pi p^2} \left(\sin pt + \frac{1}{3^3} \sin 3pt + \dots \right) - \frac{\pi n^2 r}{2p} t \quad (74)$$

Since this holds for all values of t , we must have

$$\left. \begin{aligned} V \left(\frac{d\xi}{dt} \right)_0 &= -\frac{A}{p} \sin \chi + \frac{\pi n^2 r}{2p} \\ V \xi_0 &= -\frac{A}{p^2} \cos \chi \\ V \xi &= -\frac{A}{p^2} \cos (pt - \chi) + \frac{4 n^2 r}{\pi p^2} \left(\sin pt + \frac{1}{3^3} \sin 3pt \cdot \cdot \cdot \right) \end{aligned} \right\} \quad (75)$$

The series converges so rapidly that we may neglect all but the first term; indeed, if we attempt to draw the curve represented by the series making the amplitude of the first term 25 mm., that of the second term would be a little less than 1 mm. and would have a small effect (see figure 45); that of the third term would only be $\frac{1}{3}$ mm., and its effect would hardly be perceptible on this scale. When we consider that the friction is by no means constant during a half swing of the pendulum, and that the curve recorded by our instrument is by no means an accurately harmonic curve, we feel entirely justified in accepting the value of ξ obtained by neglecting all terms of the series except the first, as representing its true value well within the limits of our observations. We then have

$$V \xi = -\frac{A}{p^2} \cos (pt - \chi) + \frac{4 n^2 r}{\pi p^2} \sin pt = B \cos (pt - \phi) \quad (76)$$

where

$$B \cos \phi = -\frac{A}{p^2} \cos \chi \quad B \sin \phi = -\frac{A}{p^2} \sin \chi + \frac{4 n^2 r}{\pi p^2} \quad B^2 = \frac{A^2}{p^4} - \frac{8 n^2 r}{\pi p^4} A \sin \chi + \frac{16 n^4 r^2}{\pi^2 p^4} \quad (77)$$

If, however, we wish to take into account the second term of the series in equation (75), the second term of equation (76) must be increased by $(4 n^2 r / \pi p^2) (\sin 3pt / 27)$, and we observe that it will have no effect on the maximum amplitude if ϕ is 0, or $\pm 60^\circ$, or

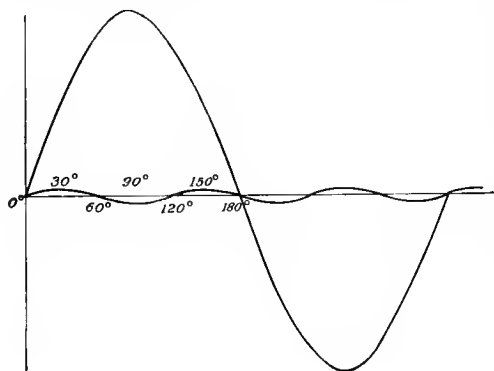

FIG. 45.

$\pm 120^\circ$, or $\pm 180^\circ$; that it will increase B by $4 n^2 r / 27 \pi p^2$ if $\phi = +30^\circ$, or $+150^\circ$, or -90° ; that it will decrease it by the same amount if $\phi = -30^\circ$, or -150° , or $+90^\circ$. If we suppose the period of the disturbance to be twice that of the pendulum, $n^2/p^2 = 4$; and if $r = 0.2$ cm., then the change in B may, at most, amount to $0.8 \times 4/27 \pi$, or about $\frac{1}{3}$ mm.; and if V is 10, the alteration in the calculated value of the amplitude of the earth's disturbance may amount to $\frac{1}{2} \frac{1}{3}$ mm. As the actual amplitude is apt to be one or more millimeters to produce a movement large enough to justify us in

regarding p' as a constant and thus make these calculations apply, the effect of the second term of the series may be neglected within the limits of errors of observations and theory. These data are fair values for the Bosch-Omori seismograph; for other instruments they would have to be modified.¹

¹ If we wish to avoid all approximations in our solution, we can do so by replacing the two series of equation (73) by their values

$$\frac{\pi n^2 r}{2p} - n^2 r t = \frac{4 n^2 r}{\pi p} \left(\cos pt + \frac{1}{3^2} \cos 3pt + \cdot \cdot \cdot \right) \quad \frac{\pi n^2 r}{2p} = \frac{4 n^2 r}{\pi p} \left(1 + \frac{1}{3^2} + \cdot \cdot \cdot \right)$$

on integrating we find

$$V \xi = -\frac{A}{p^2} \cos (pt - \chi) + \frac{\pi n^2 r t}{2p} - \frac{n^2 r t^2}{2}$$

This equals the values given by equation (75) between $t=0$ and $t=P/2$; but it does not hold outside these values; and the variation from the harmonic form is not so readily seen.

We find, therefore, that a simple harmonic record corresponds pretty closely to a simple harmonic disturbance magnified in the proportion of

$$W = \frac{a_0}{B/V} = \frac{a_0 V}{\sqrt{A^2/p^4 + (8 n^2 r/\pi p^4) A \sin \chi + 16 n^4 r^2/\pi^2 p^4}} \quad (78)$$

since B/V is the amplitude of the movement of the support or the earth. In the simple case where $r = 0$, or where it is small enough to be neglected, the denominator reduces to A/p^2 , and we have, substituting the value of A/p^2 from equation (72)

$$W = \frac{V}{\sqrt{4P^2(\kappa/2\pi)^2 + \{(P/T_0)^2 - 1\}^2}} = \frac{V}{\sqrt{4(\kappa T_0/2\pi)^2(P/T_0)^2 + \{(P/T_0)^2 - 1\}^2}} \quad (79)$$

or by equation (44b)

$$W = \frac{V}{\sqrt{4 \frac{\log^2 \epsilon}{1.862 + \log^2 \epsilon} \left(\frac{P}{T_0}\right)^2 + \left\{\left(\frac{P}{T_0}\right)^2 + 1\right\}}} \quad (79a)$$

This is the formula given by Doctor Zoeppritz and is perhaps in as simple form for calculation as it could be put. It is a function of the ratio P/T_0 ; the constants of the instrument are taken account of in the quantities, T_0 , ϵ , and V ; the latter we have seen equals \bar{n}/L . In the particular case where $P = T_0$, the magnifying power becomes

$$W = \frac{V\pi}{\kappa T_0} = \frac{V\sqrt{\pi^2 + \log^2 \epsilon}}{2 \log \epsilon} = \frac{V\sqrt{1.862 + \log^2 \epsilon}}{2 \log \epsilon} \quad (80)$$

which grows larger as κ or ϵ grows smaller; but neither κ nor ϵ can ever absolutely vanish, and therefore this magnifying power can never become infinite, though it may become very large.

If the solid friction may not be neglected, we must use the full denominator of equation (78) and the magnifying power becomes

$$W = \frac{a_0}{B/V} = \frac{V}{\sqrt{4(\kappa T_0/2\pi)^2(P/T_0)^2 + \{(P/T_0)^2 - 1\}^2 + 4(\kappa T_0/2\pi)(P/T_0)(4r/\pi a_0)(P/T_0)^2 + (4r/\pi a_0)^2(P/T_0)^4}} \quad (81)$$

in which $(\kappa T_0/2\pi)$ may be replaced by its value given in equation (44b).

The solid friction adds two terms to the denominator and reduces the magnifying power; these terms depend not only on the value of κT_0 , P/T_0 , and r , but also on the recorded amplitude, becoming less important as the amplitude increases. These formulæ, equations (79 a) and (81), are rather complicated, and could not be easily and quickly computed.¹ In reporting amplitudes, it would be much better for each observer to determine the magnifying power of his instrument and to report the actual movement of the ground, instead of the movement of his instrument as is usually done.

We have found (p. 168) that a simple harmonic vibration of the pointer, $a = a_0 \cos pt$, is the result of an approximately simple harmonic disturbance of the support, $\xi = (B/V) \cos(pt - \phi)$. This result is true whatever be the value of κ , therefore it holds whether the free movement of the pendulum is simple harmonic as on page 158, or an exponential curve as on pages 159 and 165. We can reverse the result and say a simple harmonic movement of the support will produce an approximately simple harmonic movement of the pointer.

¹ A table, giving the values of the denominators of (79 b) for various values of ϵ , and of P/T_0 has been published by Dr. Karl Zoeppritz in "Seismische Registrierungen in Göttingen im Jahre 1906." Nach. d. K. Gesells. d. Wiss. Math.-Phys. Kl. Göttingen, 1908.

If the movements of the pendulum are simple harmonic, and due to tilts alone without linear displacements, we merely interchange $-Vg\omega_y$ for $Vd^2\xi/dt^2$ in equation (71); we get

$$\omega_y = -\frac{A}{Vg} \cos(pt - \chi) \mp p' \tag{82}$$

As ω_y does not enter the equation as a derivative, no integration is necessary. p' changes its value suddenly from $+p'$ to $-p'$, or *vice versa*, when pt is zero or any multiple of π ; therefore ω_y consists of parts of a simple harmonic curve separated by sudden discontinuities at these times. But as we can not admit discontinuities in the value of ω_y , we must conclude that when p' has an appreciable value, a simple harmonic movement of the pointer can not be produced by tilts of the ground.

We are therefore led to reverse the process and determine what movement of the pointer would be produced by a simple harmonic tilt of the ground. We must replace $Vg\omega_y$ in equation (67) by $E \cos(pt - \psi_0)$, and integrate the equation after omitting $Vd^2\xi/dt^2$. (The same solution would apply to the case of simple harmonic linear displacements if we omitted $Vg\omega_y$, and replaced $Vd^2\xi/dt^2$ by $E \cos(pt - \psi_0)$; that is, if we made $\xi = -(E/Vp^2) \cos(pt - \psi_0)$.) The solution of the equation would then be very simple if we could neglect p' , but when we consider this term it becomes rather complicated; but it can be found. From the nature of the disturbing force, and on account of the damping and friction, it is evident that after a short time the movement of the pendulum must become periodic and have the same period as the force. We can therefore write the solution in the general form

$$a = a_1(\cos pt - \psi_1) + a_2 \cos(2pt - \psi_2) + \dots \text{etc.} = \Sigma a_m \cos(mpt - \psi_m) \tag{83}$$

where m represents all positive integers. It is also evident that the arms of the broken curve in figure 46 (which represents the

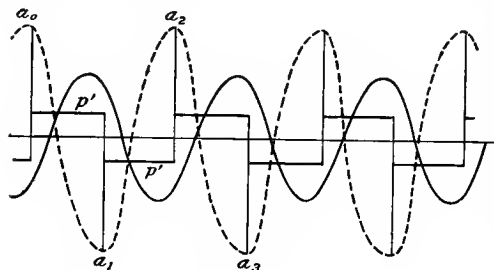

FIG. 46.

movements of the pointer; the continuous curve represents the disturbance) from a_0 to a_1 and from a_1 to a_2 , must be perfectly similar, as the forces when the pendulum is moving in one direction are exactly the negative of those when it is moving in the opposite direction. Therefore the time the pendulum takes to swing from a_0 to a_1 will be exactly half its period, and if we take the time as zero when the pendulum is at a_0 , its maximum displacement, we can develop p' as a series of sines of the form of equation (70). Substituting these values in equation (67), after omitting $Vd^2\xi/dt^2$, and requiring the equation to be identically satisfied, we have, with the equation $da/dt = 0$ when $t = 0$, a sufficient number of conditions to determine the values of the amplitudes a_1, a_2 , etc., and the phases ψ_1, ψ_2 , etc., of equation (83), and thus completely to determine this solution. The work is rather long and it will be sufficient to give the result. We find for the solution

$$\left. \begin{aligned} a_1 &= \sqrt{Q^2 + S^2/p} \\ a_m &= \frac{Q}{p} \cos pt + \frac{S}{p} \sin pt - \sum \frac{4 n^2 r}{\pi m} \frac{2 \kappa m p \cos mpt + (m^2 p^2 - n^2) \sin mpt}{(m^2 p^2 - n^2)^2 + (2 \kappa m p)^2} \end{aligned} \right\} \tag{84}$$

where m has all odd positive integral values greater than 1. $a_m = 0$, when m is even.

$$S = \sum \frac{4 n^2 r}{\pi m} \frac{m^2 p^2 - n^2}{(m^2 p^2 - n^2)^2 + (2 \kappa m p)^2}$$

with the same values of m .

Q is found from the quadratic equation

$$Q^2 \frac{N^2 + (2\kappa p)^2}{p^2} + 2Q \frac{8\kappa n^2 r}{\pi} + S^2 \frac{N^2 + (2\kappa p)^2}{p^2} + \left(\frac{4n^2 r}{\pi}\right)^2 - \frac{8NSn^2 r}{\pi p} - E^2 = 0$$

where N is written for $n^2 - p^2$. The other letters have the same meanings as heretofore.

$$\sin \psi_m = \frac{m^2 p^2 - n^2}{\sqrt{(m^2 p^2 - n^2)^2 + (2\kappa m p)^2}} \quad \cos \psi_m = \frac{2\kappa m p}{\sqrt{(m^2 p^2 - n^2)^2 + (2\kappa m p)^2}}$$

The presence of both sine and cosine terms in (84) shows that the movement of the pointer is not symmetrical about a vertical line. The solution is too complicated to be of any general use and is another example of the disadvantage of solid friction in our seismographs.

If the disturbance is small, it may not be strong enough to overcome the solid friction; referring again to equation (67), we see that no record will be made in the case of linear displacements unless

$$d^2\xi/dt^2 > p'/V, \text{ or } > n^2 r/V, \text{ or } > 4\pi^2 r/VT_0^2, \text{ or } > \phi \bar{m} l_1/Ml;$$

if

$$\xi = X \cos pt$$

we must have the maximum acceleration, $p^2 X > n^2 r/V$; that is, $X > (P/T_0)^2 r/V$, or $> (P/2\pi)^2 \phi \bar{m} l_1/Ml$. If the disturbance is a small tilt, ω_y must be greater than p'/Vg ; if $\omega_y = \Omega \cos qt$, in order that a record be made we must have $\Omega > 4\pi^2 r/VgT_0^2$, or $> \phi \bar{m} l_1/Mlg$. In studying the action of solid friction it has been supposed to be due both to friction at the pivots and to friction of the marking point; where the latter exists at all it is apt to be much greater than the former. If we are dealing with small disturbances of periods not very short, the friction at the marking point is no longer a constant, but has the characteristic of viscous damping. So that in determining the smallest disturbance that will produce a record, under these conditions, we must suppose p' to refer to the pivots only and not to the marking point.

Professor Marvin has shown how ϕ , and consequently p' and r , can be practically reduced. He attaches a small electric vibrator to the frame carrying the lever, and the successive slight jars produced by it diminish the effective solid friction to a large extent.¹

The solutions we have found, showing the relations between the disturbance and the record when solid friction is present, refer to the final steady condition and do not apply to the beginning of the disturbance. The character of the record at the beginning of a simple harmonic disturbance can not be shown in a continuous form, as we can not represent p' as a series unless it is periodic and we know the times when it changes sign. In the beginning of a disturbance these conditions will, in general, not hold. The same remark applies to the case where the disturbance consists of two or more simple harmonic motions of different periods. But if p' can be neglected, these difficulties disappear and the solution of equation (67) becomes simple. If we suppose the disturbance to be made up of a number of simple harmonic linear displacements and tilts, we must write in the equation:

$$\left. \begin{aligned} V\xi &= C_1 \cos(p_1 t - \chi_1) + C_2 \cos(p_2 t - \chi_2) + \dots \\ V \frac{d^2\xi}{dt^2} &= -\frac{C_1}{p_1^2} \cos(p_1 t - \chi_1) - \frac{C_2}{p_2^2} \cos(p_2 t - \chi_2) + \dots \end{aligned} \right\} \quad (85)$$

$$\text{and we must write} \quad Vg\omega_y = D_1 \cos(q_1 t - \phi_1) + D_2 \cos(q_2 t - \phi_2) + \dots \quad (86)$$

¹ Improvements in Seismographs with Mechanical Registration. Monthly Weather Review, 1906, vol. xxxiv, pp. 212-217.

The solution then becomes

$$a = K + a_1 \cos(p_1 t - \chi_1') + a_2 \cos(p_2 t - \chi_2') + \text{etc.} + b_1 \cos(q_1 t - \psi_1') + b_2 \cos(q_2 t - \psi_2') + \text{etc.} \quad (87)$$

where

$$\left. \begin{aligned} a_1 &= \frac{C_1 p_1^2}{\sqrt{(n^2 - p_1^2)^2 + (2 \kappa p_1)^2}} = \frac{C_1}{\sqrt{\{(P_1/T_0)^2 - 1\}^2 + 4(\kappa T_0/2\pi)^2 (P_1/T_0)^2}} = \frac{C_1}{\Delta} \\ \sin(\chi_1' - \chi_1) &= \frac{2 \kappa p_1}{\sqrt{(n^2 - p_1^2)^2 + (2 \kappa p_1)^2}} = \frac{2(\kappa T_0/2\pi)(P_1/T_0)}{\Delta} \\ \cos(\chi_1' - \chi_1) &= \frac{n^2 - p_1^2}{\sqrt{(n^2 - p_1^2)^2 + (2 \kappa p_1)^2}} = \frac{(P_1/T_0)^2 - 1}{\Delta} \\ b_1 &= \frac{D_1}{\sqrt{(n^2 - q_1^2)^2 + (2 \kappa q_1)^2}} = \frac{D_1(L/g^i)(Q_1/T_0)^2}{\sqrt{\{(Q_1/T_0)^2 - 1\}^2 + 4(\kappa T_0/2\pi)^2 (Q_1/T_0)^2}} = \frac{D_1(L/g^i)(Q_1/T_0)^2}{\Delta'} \\ \sin(\psi_1' - \psi_1) &= \frac{2(\kappa T_0/2\pi)(Q_1/T_0)}{\Delta'}; \quad \cos(\psi_1' - \psi_1) = \frac{(Q_1/T_0)^2 - 1}{\Delta'} \end{aligned} \right\} \quad (88)$$

with similar forms for the other subscripts; the values of Δ and Δ' are evident. And

$$\left. \begin{aligned} K &= A_1 e^{-\kappa t} \sin(2\pi/T)(t - t_0); \quad \text{when } \kappa < 2\pi/T_0 \\ &= e^{-\kappa t} (A_1 + A_2 t); \quad \text{when } \kappa = 2\pi/T_0 \\ &= A_1 e^{-m_1 t} + A_2 e^{-m_2 t}; \quad \text{when } \kappa > 2\pi/T_0 \end{aligned} \right\} \quad (89)$$

where A_1 , A_2 , and t_0 are arbitrary constants to be determined to satisfy the initial conditions; the value of $2\pi/T$ is given by equation (37) and the values of m_1 and m_2 by equation (59).

We see therefore that the movements of the pointer will consist of a number of simple harmonic motions of the same periods as the disturbance, but with a difference of phase, and of the proper movement of the pendulum, which is well marked at the beginning of the movement, but dies down more rapidly as κ is larger. Altho we have seen that we can not get a general solution when there is solid friction, as we have when this is absent, nevertheless it seems pretty certain that the effect of solid friction would be to shorten the interval of irregular movement of the pendulum before the regular harmonic movements are established.

MAGNIFICATION OF HARMONIC DISTURBANCES.

The magnification of each simple linear harmonic movement is given by the ratio of the amplitude of the pointer to that of the disturbance corresponding to that movement; that is, $a \div C_1/V$; this becomes

$$W = \frac{a_1 V}{C_1} = \frac{p_1^2 V}{\sqrt{(n^2 - p_1^2)^2 + (2 \kappa p_1)^2}} = \frac{V}{\sqrt{\{(P_1/T_0)^2 - 1\}^2 + 4(\kappa T_0/2\pi)^2 (P_1/T_0)^2}} \quad (90)$$

which is the expression we have already found in equation (79).

To determine the magnifying power for tilts, we must compare the maximum angular displacement of the marking lever with the maximum angular tilt of the support. If \bar{l} is the length of the long arm of the marking lever, its maximum angular displacement for a particular movement will be b_1/\bar{l} ; and the maximum tilt will be D_1/Vg ; the ratio becomes

$$U = \frac{b_1 V g}{D_1 \bar{l}} = \frac{\bar{n}}{i} \frac{(Q_1/T_0)^2}{\sqrt{\{(Q_1/T_0)^2 - 1\}^2 + 4(\kappa T_0/2\pi)^2 (Q_1/T_0)^2}} \quad (91)$$

here Q_1 is the period of that particular movement of the support.

A glance at equations (88), (90), and (91) shows that in the record the magnification and change of phase of the various harmonic movements of the disturbance are different for different periods, and therefore the curve of the record will not be the same as the

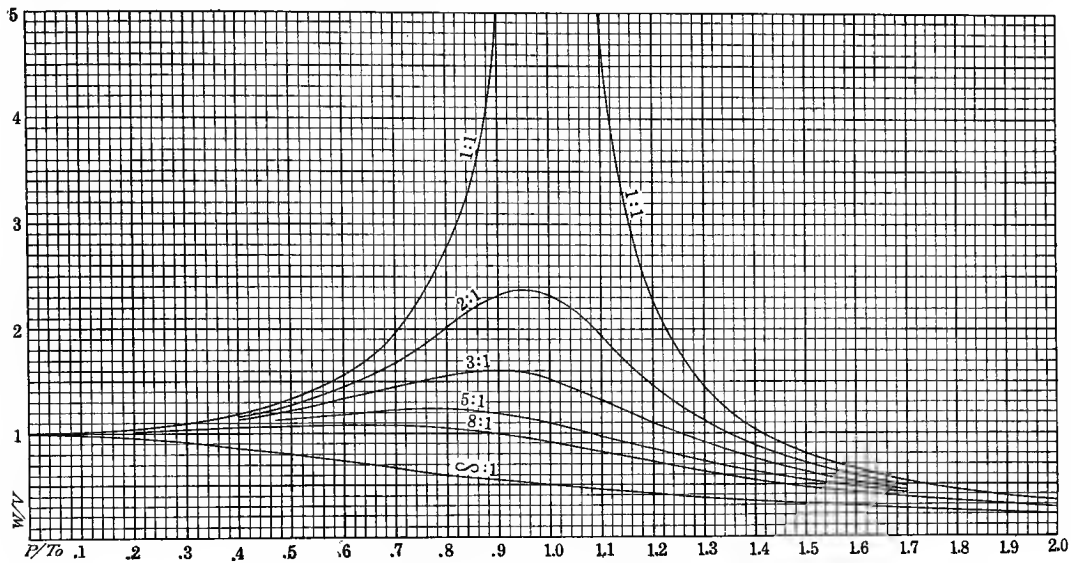

FIG. 47. — Magnifying power of linear displacements.

curve of the disturbance, if the latter consists of movements of more than one period; and it is not possible by increasing κ to equalize the magnification of the movements for different periods and the phase differences, and make the two curves alike; but it might be possible to pick out the different harmonic movements in the record and then

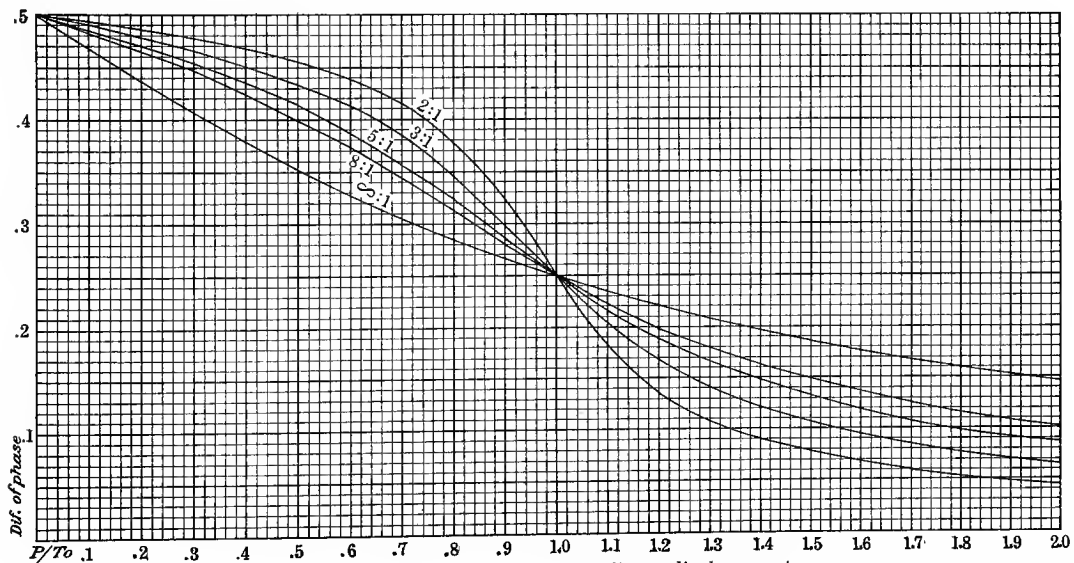

FIG. 48. — Differences of phase for linear displacements.

to calculate the harmonic movements of the disturbance; we could not, however, determine whether these movements were linear displacements or tilts. To make clear the influence of damping, I have, following Professor Wiechert, drawn the diagrams, figures 47 and 48. Figure 47 shows the relative magnifying powers for various values of the damping ratio and for different ratios of the periods of the

disturbance and the free period of the pendulum; the curves are calculated from equation (90). Figure 48 shows the phase differences for the same variables calculated from equation (88).¹ We notice that for values of ϵ not too large, the magnifying power increases with the ratio of the periods to a maximum and then diminishes indefinitely. The position of the maximum, found by equating to zero the derivative of (90) with respect to P/T_0 , occurs when

$$\left(\frac{P}{T_0}\right)^2 = 1 - 2\left(\frac{\kappa T_0}{2\pi}\right)^2 \quad (92)$$

and its value is

$$W(max) = \frac{V}{\sqrt{1 - (P/T_0)^4}} \quad (93)$$

For small values of ϵ the magnifying power varies enormously for different periods, becoming very large for periods approaching the free period. Instruments with small damping emphasize certain periods unduly. As we increase ϵ , W becomes more uniform and when ϵ is about 8:1, W varies by less than one-tenth of its value for all periods up to the free period, and is very nearly equal to V . This amount of damping would be excellent, but it would not make the curves of disturbance and record alike, for altho the magnification of the different periods would be practically the same, figure 48 shows that the phase differences would not. Nevertheless this offers great advantages; in the case of nearly simple harmonic movements, which probably occur not infrequently, our record would show the magnifying power without long calculations, whatever be the period, up to the free period; and the record would show directly the relative displacements in different parts of the disturbance, without unduly magnifying certain parts. With this value of the damping ratio the proper movements of the pendulum would be damped out in one or two vibrations. The longer the proper period of the pendulum, the greater the range of periods over which the magnifying power remains nearly constant. This is the principal advantage of long proper periods when recording harmonic disturbances.

For increasing values of ϵ the position of the maximum moves to the left and becomes zero when $1 - 2(\kappa T_0/2\pi)^2 = 0$, which corresponds to $\epsilon = 23:1$. For values of ϵ greater than this there is no maximum; the magnification is greatest for infinitely small values of P/T_0 and diminishes for all greater values; when ϵ becomes $\infty:1$; $2\pi/\kappa T_0$ equals unity, and the instrument is deadbeat; W is considerably diminished and varies greatly in value.

The magnifying power for tilts is shown in figure 49; it is equal to the variable part of that for displacements multiplied by $(\bar{n}/i)(Q/T_0)^2$. Its value is zero when Q/T_0 is indefinitely small; it increases with this factor and reaches a maximum when

$$\frac{Q}{T_0} = \frac{1}{1 - 2(\kappa T_0/2\pi)^2} \quad (92a)$$

when its value is

$$U(max) = \frac{\bar{n}}{i} \frac{(Q/T_0)^2}{\sqrt{Q/T_0^4 - 1}} \quad (93a)$$

it then diminishes to \bar{n}/i when Q/T_0 is indefinitely large. The position of the maximum is at $Q/T_0 = 1$ when $\epsilon = 1$ (*i.e.*, $\kappa = 0$); it moves to the right as ϵ increases, reaching infinity when $1 - 2(\kappa T_0/2\pi)^2 = 0$; or $\epsilon = 23.1$. For greater values of ϵ there is no maximum. There is no value of ϵ which produces a fairly even degree of magnification for even a

¹ For $\epsilon = 1:1$, the difference of phase is 0.5 for values of P/T_0 less than 1; and is 0 for values of P/T_0 greater than 1.

small range of values of Q/T_0 when this ratio is not large, except a value large enough to reduce the displacement of the pointer to a small fraction of that of the earth.

The factor independent of the period is \bar{n}/i ; and this can be increased indefinitely by increasing the number and magnifying power of the levers, and by diminishing i ;

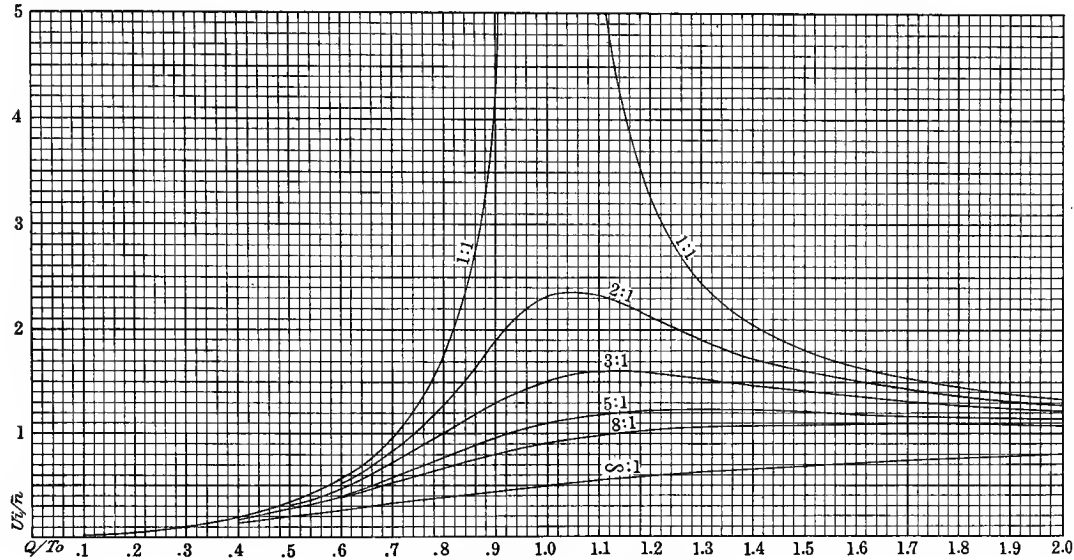

FIG. 49.—Magnifying power for tilts.

we are, however, confronted by the friction of the marking point, which becomes so important as we increase the magnifying power that small tilts are not recorded. But this can be overcome if optical methods of registration are used; and if the friction at the pivots is avoided by methods mentioned further on.

MAXIMUM MAGNIFYING POWERS.

It is important to magnify largely the movements of the ground by the seismographs; instruments in present use, which apparently magnify eight or ten times, give sufficiently large records of parts of strong distant earthquakes; but this is principally due to lack of damping and to the fact that the periods of the waves harmonize with the proper periods of the pendulums. If these pendulums were damped to a ratio of 8:1, we should get much smaller records. Let us see how V , the other factor in the magnifying power of linear displacements, which is independent of the period, can be altered. It might appear that this factor could be increased indefinitely by increasing the number of the multiplying levers, and the ratio of their long to their short arms; but this is not so, even when we neglect the solid friction. The value of V given in equations (29) becomes, on replacing \bar{n} and L by their values,

$$V = \frac{M \bar{n}_1 \bar{n}_2 \dots \bar{n}_x \bar{l}}{I + n_1^2 I' + n_1^2 n_2^2 I'' \dots + (n_1^2 n_2^2 \dots n_x^2) I^x}$$

where x is the number of levers; and the subscripts of the I 's are omitted. Let us suppose that the levers are all alike; we may then write (using the same notation as before), $n_2 = n_3 = n_4 \dots$ etc. = m , the multiplying power of each lever, and $I' = I'' \dots = kI$; the equation becomes

$$V = \frac{M \bar{l} \bar{n}_1 m^{x-1}}{I \{1 + n_1^2 k (1 + m^2 + m^4 \dots + m^{2(x-1)})\}} = \frac{M \bar{l} \bar{n}_1 m^x}{m I \{1 + n_1^2 k (m^{2x} - 1)/(m^2 - 1)\}} \quad (94)$$

We can use various values of n_1 , but the best is when $n_1^2 k (m^{2x} - 1) / (m^2 - 1) = 1$, which gives for the magnifying power

$$V(max) = \frac{M\bar{l}}{2I\sqrt{k}} \sqrt{\frac{m^2 - 1}{m^2} \cdot \frac{m^{2x}}{m^{2x} - 1}} \quad (95)$$

x can not be less than 1, and m is usually much greater, so that the radical never differs much from unity; it can therefore be neglected, and we see that the maximum value of V is independent of the number of levers used, if we give n_1 its best values. If we use only one lever, $n_1^2 = 1/k$. This is not always practicable; for instance, for the Bosch-Omori instrument, $1/k = 220,000$; $\therefore n_1 = 470$; and since $l_1 = 75$ cm., l_2 becomes 0.15 cm.

On the other hand, we can determine the best numbers of levers to use by determining the maximum value of V for variations of x in equation (94). This gives

$$x = \frac{1}{2 \log m} \log \frac{m^2 - 1 - n_1^2 k}{n_1^2 k} \quad V(max) = \frac{M\bar{l}(m^2 - 1)}{2mI\sqrt{k}\sqrt{m^2 - 1 - n_1^2 k}} \quad (96)$$

For the Bosch-Omori instrument, $n_1^2 k = \frac{1}{220,000}$, about, and with $m = 10$, x becomes 2.17, and the maximum value of V is 78. If we omit $n_1^2 k$ and 1 in comparison with m^2 , the above expressions become

$$x = \frac{1}{2 \log m} \log \frac{m^2}{n_1^2 k} = \frac{1}{2 \log m} \log \frac{l^2}{l_1^2 k} \quad V(max) = \frac{M\bar{l}}{2I\sqrt{k}} \quad (97)$$

k and \bar{l} are not independent; replace k by its value, I'/I . The moment of inertia, I' , of each lever is principally that of the long arm, as the short arm counts but little; if we double the length of the lever, we must at least quadruple its mass to keep it strong enough; we may therefore suppose its moment of inertia equal to $\mu \bar{l}^4$; introducing this into the values of x and of $V(max)$ we get

$$x = \frac{1}{2 \log m} \log \frac{I}{\mu l_1^2 l^2} \quad V(max) = \frac{Ml}{2\bar{l}\sqrt{\mu I}} \quad (98)$$

and we see that we get a greater multiplying power, if we use short and light levers, rather than a smaller number of longer and correspondingly heavier ones. μ depends on the density and distribution of material in the levers, and should be made as small as possible. Ml/\sqrt{I} varies proportionally with \sqrt{M} , but very little with l , if l is several times as large as the radius of gyration of the pendulum about its center of gravity; therefore $V(max)$ can be increased by increasing M , rather than by increasing l .

We have not considered the solid friction of the marking point, which, as has been shown on page 171, increases the minimum acceleration which can be registered in the proportion of the multiplying power of the levers, and is in general so great that it exerts a controlling influence over the possible magnifying power of the instrument. The investigation, therefore, does not apply directly to seismographs with mechanical registration, but would apply to instruments of the same form if direct photographic registration, as in the Milne instrument, were used at the end of the last lever.

This suggests a method of optical registration by which very high magnification can be obtained without placing the recording paper far from the instrument. In the usual optical method the light is reflected directly from a mirror carried by the pendulum; but if the mirror is carried on the axle of a magnifying lever, the angle thru which it turns can be increased very greatly (fig. 50). The magnifying power becomes

$$V = \frac{2 d\theta'}{L\theta} = \frac{2 M l n_1 d}{I + n_1^2 I'} \quad (99)$$

where d is the distance from the mirror to the recording paper. The best value of n_1^2 is I/I' , and the corresponding magnification is $Mld/\sqrt{II'}$. As an example, suppose the pendulum consists of a mass of 10 kg. placed at a distance of 20 cm. from the axis of rotation; I would be 4×10^6 cm.²gm.; let I' be 4×10^2 cm.²gm., a little greater than that of the lever of the Bosch-Omori instrument; then $I/I' = 10^4$, and $n_1 = 100$. If $d = 100$ cm., the magnifying power becomes 500. If we desire any other magnification, we can

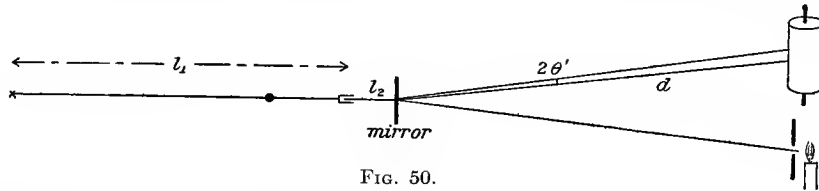

FIG. 50.

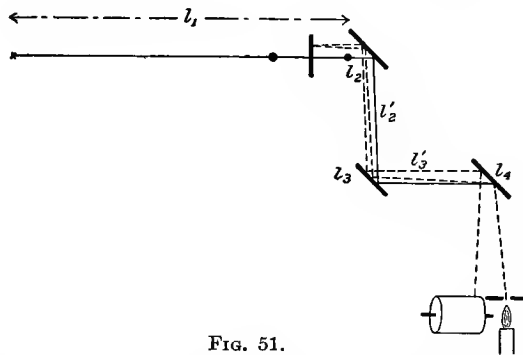

FIG. 51.

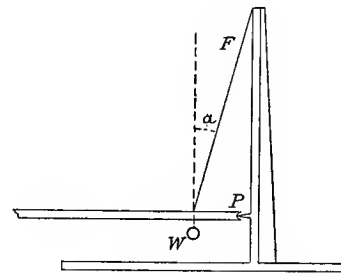

FIG. 52.

select the proper values of M , l , n_1 and d to give it. If a very high value of V is desired, the arrangement shown in figure 51 can be used. The light is reflected twice from each mirror and at each reflection is deflected thru twice the angle of rotation of the mirror. The magnification becomes

$$V = \frac{Mld \ 4 \ n_1 \ (1 + m + m^2 + \dots + m^{x-1})}{I + n_1^2 I' \{1 + m^2 + \dots + m^{2(x-1)}\}} = \frac{Mld \ 4 \ n_1 \ (m + 1) \ (m^x - 1)}{I(m^2 - 1) + n_1^2 I' (m^{2x} - 1)} \quad (100)$$

d is the distance from the last mirror, following the course of the light, to the drum. We have neglected the angle thru which the light is turned by the mirror on the pendulum, for with any fairly large value of n_1 it is very small as compared with the total deflection of the light. The best value of n_1 is given by

$$n_1^2 I' (m^{2x} - 1) = I(m^2 - 1), \text{ or } n_1^2 = (I/I') (m^2 - 1)/(m^{2x} - 1)$$

and

$$V(max) = \frac{2 \ Mld}{\sqrt{II'}} \sqrt{\frac{m^x - 1}{m - 1} \frac{m + 1}{m^x + 1}} \quad (101)$$

The radical is largest when x is large, but it does not vary much; when $x = 1$, it equals 1; when $x = 2$, it equals $\sqrt{(m + 1)^2(m^2 + 1)}$, which equals 1.095 if $m = 10$; and when $x = \infty$ and $m = 10$ it equals 1.111; so that very little is gained by increasing the number of levers, except to get a proper value of n_1 more easily. If $M = 10,000$ gm., $l = 20$ cm., $d = 100$ cm., $I = 4 \times 10^6$, $I' = 4 \times 10^2$, $x = 1$; then $n_1 = 100$; and $V(max) = 2 \ Mld/4 \times 10^4 = 1000$. If we make $x = 2$, and $m = 10$; then $n_1 = 10$ and $V(max) = 1090$.

If the value of n_1 were fixed, we should find for the best number of levers to use, and the corresponding maximum magnification

$$x = \frac{1}{\log m} \log \left(1 + \sqrt{\frac{I}{I'} \frac{m^2 - 1}{n_1^2}} \right) \quad V(max) = \frac{2 \ Mld \ (m + 1)}{m_1 I' + \sqrt{II'} (m^2 - 1)} \quad (102)$$

Taking $n_1 = 50$ and the rest of the data as before, we get $x = 1.32$, and $V(max) = 1000$, the same value as before; but if we make $x = 1$, the nearest practical value, we find $V(max) = 800$, which is not very much less. By using steel ribbon for connectors at the axes, and between the pendulum and the levers, or by using one of the devices suggested by Dr. C. Mainka,¹ we could easily get rid of solid friction, and realize the theoretical values above.

SUSPENSIONS OF HORIZONTAL PENDULUMS.

There are 4 forms of suspension for horizontal pendulums: (1) The Gray suspension (figure 52); a horizontal beam carrying a weight presses against a point, and is supported by a tie thru its center of gravity. Let F be the tension of the tie, P the pressure at the pivot, supposed horizontal, and W the weight; for equilibrium, these 3 forces must pass thru the same point and we must have

$$F \cos \alpha = W, \text{ or } F = W / \cos \alpha \quad F \sin \alpha = P = W \tan \alpha \quad (103)$$

The friction at P depends upon the pressure there; and we see it is less as α is smaller. This can be brought about either by putting the weight closer to the pivot or by lengthening the distance between the two points of support. By the first method we shorten the distance of the CG from the axis of rotation, and we change the values of the constants in the general equation; by the second method, these constants are not affected.

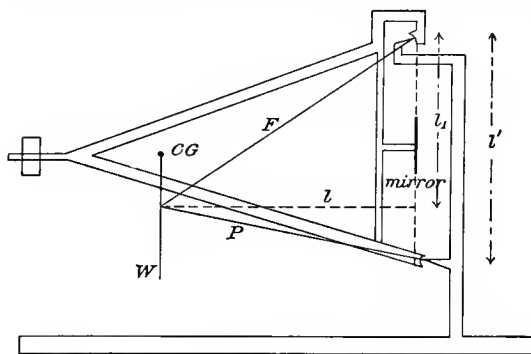

FIG. 53.

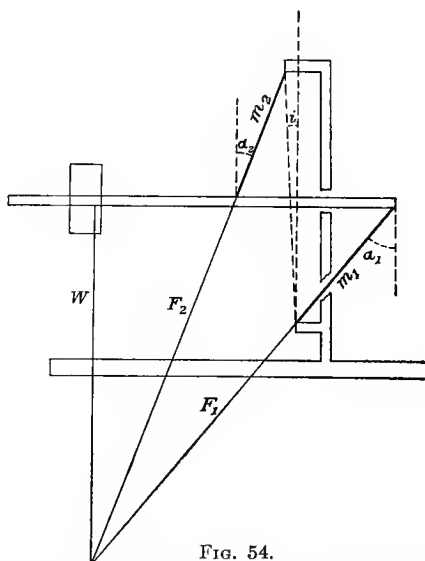

FIG. 54.

(2) The Ewing suspension: this differs from the preceding only in replacing the pivot by a thin steel ribbon, thus doing away with the friction at this point. The horizontal beam is extended beyond the axis of rotation and is fastened to the axis by a steel ribbon. Professor Ewing suggested that a steel pin occupying the position of the axis of rotation, and connected firmly with the support, should pass through a slot in the beam, and thus prevent lateral movements of this part of the beam; but this pin introduces some friction. This use of a steel ribbon has only lately been put into practice (by Professor Wiechert).

(3) The von Rebeur-Paschwitz suspension (figure 53): the points of support are sharp steel points resting in agate cups, the upper one being turned to produce a supporting force. The three forces P , F , and W must meet in a point, which is vertically below or above the center of gravity.

¹ Kurze Uebersicht über die modernen Erdbeben-Instrumente. Die Mechaniker, XV Jahrgang, 1907. Since the above was written Prof. C. F. Marvin has suggested a practically similar method for increasing the magnifying power. "A Universal Seismograph for Horizontal Motion." Monthly Weather Rev., 1907, vol. XXXV, pp. 522-534.

The two points of support and the center of gravity lie in a vertical plane when the instrument is in equilibrium. The direction of the forces F and P can be somewhat controlled by the direction of the points and of the cups, but friction will alter the direction of the forces to some extent. Usually a plane surface is used instead of one of the cups, which renders it unnecessary that the distance between the points should be exactly the same as the distance between the centers of the cups. Taking moments about the points of support, we find

$$F = \frac{W\sqrt{l_1^2 + l^2}}{l'} \quad P = \frac{W\sqrt{(l' - l_1)^2 + l^2}}{l'} \quad (104)$$

where the meanings of the letters are shown in the figure. These forces become equal when $l_1 = l'/2$, and they make equal angles with the vertical; they then pass thru the CG ; they become smaller as l' becomes larger in comparison with l . When the lower point presses against a vertical plane agate surface, the direction of P is horizontal, $l_1 = l'$, and

$$F = \frac{W\sqrt{l'^2 + l^2}}{l'} \quad P = W\frac{l}{l'} \quad (105)$$

If $l = l'$, $F = 1.41 P$.

(4) The Zöllner suspension (figure 54); the beam is supported by two wires m_1 and m_2 fastened to the support, one above and one below the beam. The direction of the forces must pass thru the vertical thru the CG of the beam; and therefore the angle α_1 must be greater than the angle α_2 ; but the values of these angles can only be found thru an equation of the fourth degree, and can only be expressed by a very complicated expression. The Zöllner suspension has the great advantage of not having any pivots, and therefore, if an optical method of registration is used, there is no solid friction. For very slow movements it would answer very well, but for more rapid movements its motion is too complicated. It can have linear displacements parallel with and at right angles to the beam, as well as a rotation around a nearly vertical axis at right angles to the beam. The linear movement parallel with the beam also caused a vertical movement of the mass. These various movements, themselves the effects either of linear displacements or tilts of the support, could not be separated from each other by a single registration; and it would be impossible to interpret the record. To avoid these complications Prince Galitzin has proposed to have the beam press by a point against an agate plate placed close to the axis of rotation, and he has shown that even when the pressure is very light, the device will prevent the first two movements. Another way would be to fasten the point of the beam where it crosses the axis of rotation by guy-wires. They would prevent it from moving out of this position, but would not interfere with small rotations. Prince Galitzin has suggested this method for other instruments. Either of these devices prevents all relative motion except a simple rotation, without introducing friction, and the theory of the instrument then becomes the same as that already given for the Gray or von Rebeur-Paschwitz forms. All instruments of the Zöllner type in use up to the present time have no device to prevent the complicated motions, and in attempting to interpret the records of the California earthquake as given by instruments of this type, we must assume that only rotations take place.

THE VERTICAL PENDULUM.

Let us now consider the movements of an ordinary vertical pendulum whose support is subjected to an earthquake disturbance producing the three displacements, ξ , η , ζ , and the three rotations, ω_x , ω_y , ω_z .

Let O , figure 55, be the origin of coordinates and let X , Y , and Z be the coordinates of the point of support; then if l is the distance from the point of support to the CG , the

coördinates of the CG will be $X, Y, Z-l$. In the figure, we have omitted the linear displacements for the sake of clearness, and have represented the CG , as not moved by the rotations; this introduces no error as the angular rotations are all given their proper values. As in the case of the horizontal pendulum, let us refer the motion of the pendulum to three axes fixed in the pendulum and moving with it; and which are principal axes of inertia. Axis (3) lies in the line from the point of support to the CG .

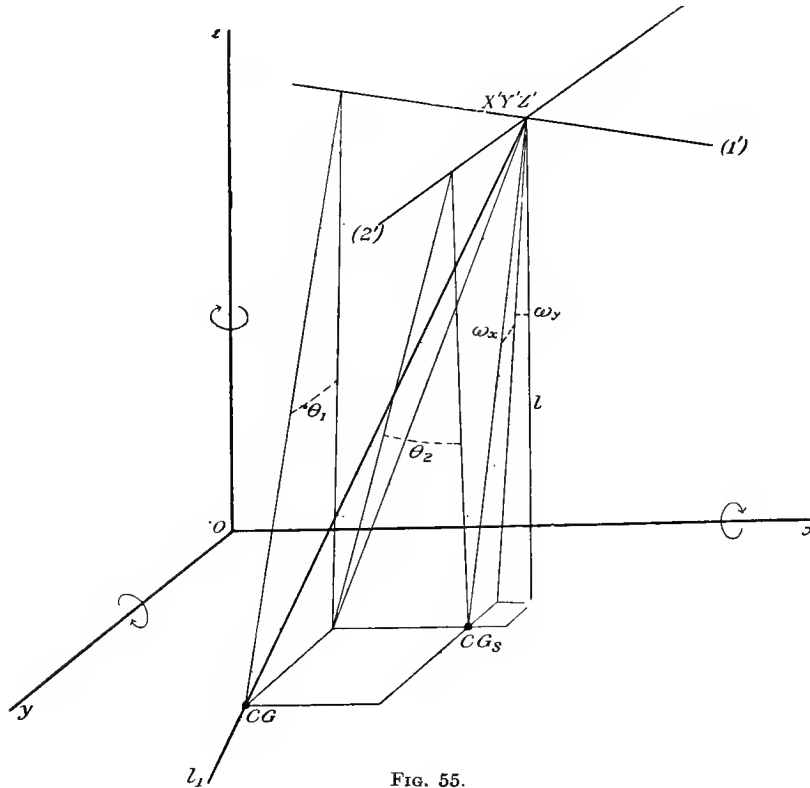

FIG. 55.

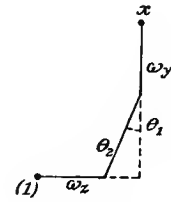

FIG. 56.

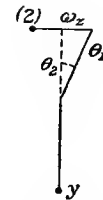

FIG. 57.

Axes (1) and (2) are the rotated positions of lines at right angles to (3) and passing thru the CG , which were, before rotation, parallel to the fixed axes of coördinates. Axes parallel with these and passing through the point of support have primes.

We assume that there is no rotation around the axis (3). If the pendulum were supported at a mathematical point, no such rotation could be set up as the direction of the force there passes through the axis; practically the support is a small surface and it might be possible for a small moment to exist around axis (3), but it would be so small that we may safely neglect it.

What is actually measured is the displacement of the CG relative to the CG_s ; that is, the angles θ_1 and θ_2 ; we must therefore form our equations of motion connecting θ_1 and θ_2 with the displacements and rotations. Using the same notation as before, except that θ_1 and θ_2 are used for the angular displacements of the CG relative to the CG_s , we follow the same method to develop the equations of the pendulum.

The linear accelerations of the CG are given by equations (4), and Euler's equations of angular accelerations around the CG are

$$I_1 \frac{d^2(\theta_1 + \omega_1)}{dt^2} = A \qquad I_2 \frac{d^2(\theta_2 + \omega_2)}{dt^2} = B \qquad (106)$$

where A and B are the moments of the forces around the axes thru the CG parallel with (1') and (2'). As before, we have neglected the term containing the product of the angular velocities, as ω_3 , and therefore its derivatives are practically zero. Let the point of contact of the pendulum and the indicator be at a distance l_1 from the point of support of the former. The indicator may be a vertical lever, in which case f_1 and f_2 are the two components of the reaction; or it may be made up of two horizontal levers with their short arms at right angles to each other, and crossing at the point of contact with the pendulum; in this case f_1 and f_2 are the normal components of the force against each lever, and the frictional components parallel to the levers are neglected as in the case of the horizontal pendulum.

The moments of the forces around the CG are

$$A = -F_2 l + f_2(l_2 - l) \quad B = F_1 l - f_1(l_1 - l) \quad (107)$$

F_1 and F_2 are given by two equations similar to equation (10); the cosines of the angles between the axes are obtained from the figures 56 and 57, in the same way as in the case of the horizontal pendulum (p. 152).

$$\left. \begin{aligned} \cos(x, 1) &= \cos \sqrt{(\omega_y + \theta_2)^2 + (\omega_x + \theta_1 \theta_2)^2} = 1 \\ \cos(y, 1) &= \sin(\omega_x + \theta_1 \theta_2) = \omega_x \\ \cos(z, 1) &= -\sin(\omega_y + \theta_2) = -(\omega_y + \theta_2) \end{aligned} \right\} \quad (108)$$

$$\left. \begin{aligned} \cos(x, 2) &= -\sin(\omega_x - \theta_1 \theta_2) = -\omega_x \\ \cos(y, 2) &= \cos \sqrt{(\omega_x + \theta_1)^2 + (\omega_x - \theta_1 \theta_2)^2} = 1 \\ \cos(z, 2) &= \sin(\omega_x + \theta_1) = (\omega_x + \theta_1) \end{aligned} \right\} \quad (109)$$

We have

$$x = \xi + (Z - l)\omega_y - Y\omega_x - l\theta_2 \quad y = \eta + X\omega_x - (Z - l)\omega_x + l\theta_1 \quad z = \zeta + Y\omega_x - X\omega_y \quad (110)$$

and

$$\left. \begin{aligned} \frac{d^2x}{dt^2} &= \frac{d^2\xi}{dt^2} + (Z - l) \frac{d^2\omega_y}{dt^2} - Y \frac{d^2\omega_x}{dt^2} - l \frac{d^2\theta_2}{dt^2} \\ \frac{d^2y}{dt^2} &= \frac{d^2\eta}{dt^2} + X \frac{d^2\omega_x}{dt^2} - (Z - l) \frac{d^2\omega_x}{dt^2} + l \frac{d^2\theta_1}{dt^2} \\ \frac{d^2z}{dt^2} &= \frac{d^2\zeta}{dt^2} + Y \frac{d^2\omega_x}{dt^2} - X \frac{d^2\omega_y}{dt^2} \end{aligned} \right\} \quad (111)$$

and therefore

$$\left. \begin{aligned} F_x &= M \frac{d^2x}{dt^2} - f_x = M \left\{ \frac{d^2\xi}{dt^2} + (Z - l) \frac{d^2\omega_y}{dt^2} - Y \frac{d^2\omega_x}{dt^2} - l \frac{d^2\theta_2}{dt^2} - \frac{f_x}{M} \right\} \\ F_y &= M \frac{d^2y}{dt^2} - f_y = M \left\{ \frac{d^2\eta}{dt^2} + X \frac{d^2\omega_x}{dt^2} - (Z - l) \frac{d^2\omega_x}{dt^2} + l \frac{d^2\theta_1}{dt^2} - \frac{f_y}{M} \right\} \\ F_z &= M \frac{d^2z}{dt^2} + Mg = M \left\{ \frac{d^2\zeta}{dt^2} + Y \frac{d^2\omega_x}{dt^2} - X \frac{d^2\omega_y}{dt^2} + g \right\} \end{aligned} \right\} \quad (112)$$

Putting the values of the cosines from equations (108) and (109) in equation (10), we get

$$F_1 = F_x + \omega_x F_y - (\omega_y + \theta_2) F_z \quad F_2 = -\omega_x F_x + F_y + (\omega_x + \theta_1) F_z \quad (113)$$

Introducing the values of F_x , F_y , and F_z into these equations, and then the values of F_1 and F_2 into equation (107), and then the values of A and B thus obtained into equations (106), we get for our equations of motion

$$I_1 \frac{d^2(\theta_1 + \omega_1)}{dt^2} = Ml \left[\left\{ \frac{d^2\xi}{dt^2} + (Z-l) \frac{d^2\omega_y}{dt^2} - Y \frac{d^2\omega_z}{dt^2} - l \frac{d^2\theta_2}{dt^2} - \frac{f_x}{M} \right\} \omega_z \right. \\ \left. - \left\{ \frac{d^2\eta}{dt^2} + X \frac{d^2\omega_x}{dt^2} - (Z-l) \frac{d^2\omega_z}{dt^2} + l \frac{d^2\theta_1}{dt^2} - \frac{f_y}{M} \right\} \right. \\ \left. - \left\{ \frac{d^2\xi}{dt^2} + Y \frac{d^2\omega_x}{dt^2} - X \frac{d^2\omega_y}{dt^2} + g \right\} (\omega_x + \theta_1) \right] + f_2(l_1 - l) \quad (114)$$

$$I_2 \frac{d^2(\theta_2 + \omega_2)}{dt^2} = Ml \left[\left\{ \frac{d^2\xi}{dt^2} + (Z-l) \frac{d^2\omega_y}{dt^2} - Y \frac{d^2\omega_z}{dt^2} - l \frac{d^2\theta_2}{dt^2} - \frac{f_x}{M} \right\} \right. \\ \left. + \left\{ \frac{d^2\eta}{dt^2} + X \frac{d^2\omega_x}{dt^2} - (Z-l) \frac{d^2\omega_z}{dt^2} + l \frac{d^2\theta_1}{dt^2} - \frac{f_y}{M} \right\} \omega_x \right. \\ \left. - \left\{ \frac{d^2\xi}{dt^2} + Y \frac{d^2\omega_x}{dt^2} - X \frac{d^2\omega_y}{dt^2} + g \right\} (\omega_y + \theta_2) \right] - f_1(l_1 - l) \quad (115)$$

If we take the point of support as our origin, the first equation becomes (since $X = Y = Z = 0$, and writing $I_{(1)} = I_1 + Ml^2$),

$$I_{(1)} \frac{d^2\theta_1}{dt^2} = Ml \left[\left(\frac{d^2\xi}{dt^2} - l \frac{d^2\omega_y}{dt^2} - l \frac{d^2\theta_2}{dt^2} - \frac{f_x}{M} \right) \omega_z \right. \\ \left. - \left(\frac{d^2\eta}{dt^2} + l \frac{d^2\omega_x}{dt^2} \right) - \left(\frac{d^2\xi}{dt^2} + g \right) (\omega_x + \theta_1) \right] + f_2 l_1 - I_1 \frac{d^2\omega_1}{dt^2} \quad (116)$$

In this equation we have assumed that $f_y = f_2$. The friction at the point of contact makes it impossible to evaluate the exact value of f ; it is, moreover, not large when the indicator is light; and these assumptions are always very nearly true. By omitting some of these terms as negligible and not considering the reaction of the indicator, and making the proper changes of notation, this equation becomes equation (81) of Professor Wiechert. If we take the original position of the CG_s as our origin, we have $X = Y = Z - l = 0$; and the equations become still simpler, namely,

$$I_{(1)} \frac{d^2\theta_1}{dt^2} = Ml \left[\left(\frac{d^2\xi}{dt^2} - l \frac{d^2\theta_2}{dt^2} - \frac{f_x}{M} \right) \omega_z - \frac{d^2\eta}{dt^2} - \left(\frac{d^2\xi}{dt^2} + g \right) (\omega_x + \theta_1) \right] + f_2 l_1 - I_1 \frac{d^2\omega_1}{dt^2} \\ I_{(2)} \frac{d^2\theta_2}{dt^2} = Ml \left[\frac{d^2\xi}{dt^2} + \left(\frac{d^2\eta}{dt^2} + l \frac{d^2\theta_1}{dt^2} - \frac{f_y}{M} \right) \omega_x - \left(\frac{d^2\xi}{dt^2} + g \right) (\omega_y + \theta_2) \right] - f_1 l_1 - I_2 \frac{d^2\omega_2}{dt^2} \quad (117)$$

where we have also put $f_x = f_1$. These equations reduce to Prince Galitzin's equation (99), on omitting certain terms and with proper changes of notation.

We can simplify further by omitting some of the terms; $d^2\xi/dt^2$ can be neglected in comparison with g , as on page 154; the terms multiplying ω_x represent the moment around (1) of the forces parallel with x , and have a value on account of the very small angle between them. These terms are very small in comparison with the terms not containing ω_x , and may be omitted; omitting also the terms $I_1 d^2\omega_1/dt^2$ and $I_2 d^2\omega_2/dt^2$ for reasons given on page 154, our equations become

$$I_{(1)} \frac{d^2\theta_1}{dt^2} = -Ml \left\{ \frac{d^2\eta}{dt^2} + g(\omega_x + \theta_1) \right\} + f_2 l_1 \quad I_{(2)} \frac{d^2\theta_2}{dt^2} = Ml \left\{ \frac{d^2\xi}{dt^2} - g(\omega_y + \theta_2) \right\} - f_1 l_1 \quad (118)$$

With these simplifications we see that the component movements of the pendulum in two directions at right angles are just the same as tho there were two simple pendulums each constrained to move in one vertical plane.

We must now substitute the values of f_2 and f_1 from the equations of the indicators, equation (22).

With the same assumptions made there, these equations are

$$I_{(1)}' \frac{d^2\theta_1'}{dt^2} = -f_2' l_2' \quad I_{(3)}'' \frac{d^2\theta_3''}{dt^2} = f_1'' l_2'' \quad (119)$$

We suppose that the pivots of the indicator lie on the positive sides of the axes of x and y respectively. These equations refer to horizontal indicators with vertical axes of rotation; the primes and seconds refer to the two indicators. If, as in the Vicentini pendulum, the first multiplying lever is vertical; then $I_{(3)'} = I_{(3)''}$; θ_3' becomes θ_1' ; and θ_3'' becomes θ_2'' ; with these changes equations (119) still hold. Assume that $f_x = f_1$ and $f_y = f_2$; write $\theta_3' = -n'\theta_1$; $\theta_3'' = -n''\theta_2$, where $n' = l_1/l_2'$ and $n'' = l_1/l_2''$; l_2' and l_2'' are the lengths of the short arms of the indicators. Remembering that $f_2 = -f_2'$, and $f_1 = -f_1''$, and substituting in equation (118) the values of f_2 and f_1 from equation (119), we get

$$(I_{(1)} + n'^2 I_{(3)'}) \frac{d^2\theta_1}{dt^2} = -Ml \left\{ \frac{d^2\eta}{dt^2} + g(\omega_x + \theta_1) \right\} \quad (I_{(2)} + n''^2 I_{(3)'}) \frac{d^2\theta_2}{dt^2} = Ml \left\{ \frac{d^2\xi}{dt^2} - g(\omega_y + \theta_2) \right\} \tag{120}$$

The second equation becomes identical with equation (23) of the horizontal pendulum if we replace $d^2\theta_2/dt^2$ by $d^2\theta/dt^2$, and θ_2 by $i\theta_2$, and shows that the actions of the two types of instruments are the same, but that, other terms in the equations being equal, the force of restitution of the horizontal pendulum is only i times as great as that of the vertical pendulum. The first equation differs only in that $d^2\eta/dt^2$ has a negative sign; this arises from the fact that a positive acceleration of η causes a negative acceleration of θ_1 , whereas a positive acceleration of ξ causes a positive acceleration of θ_2 ; which is also true of the horizontal pendulum pointing in the positive direction of y . This difference causes no confusion in practice. On introducing terms for viscous damping and solid friction, we obtain equations exactly like (25) and on passing to the recording point we get equations like (26). Therefore all that has been developed regarding the horizontal pendulum — the methods of determining the constants, the magnifying power for linear displacements and tilts, and the interpretation of the record — applies equally well to the simple vertical pendulum, if we replace i by 1.

THE INVERTED PENDULUM.

The inverted pendulum consists of a mass balanced on a point so that its CG is vertically over the point. This position is rendered stable either by springs or by a second pendulum hanging immediately above, the two being so connected that the points of contact suffer equal displacements, and their weights and lengths being so adjusted that the total force arising from a displacement tends to bring the system back to its original position.

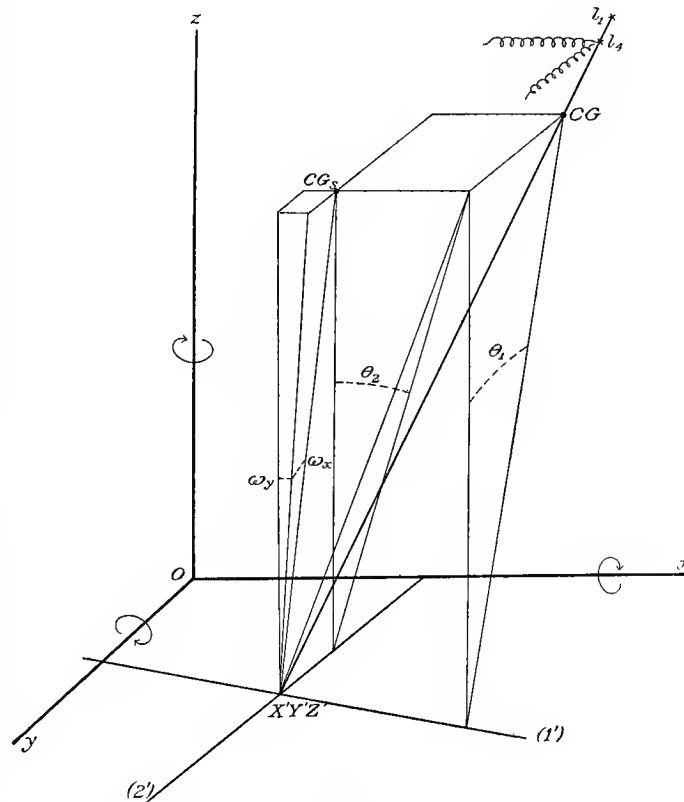

FIG. 58.

This form was originally suggested by Professor Ewing,¹ and the second type above mentioned is called "Ewing's duplex pendulum." A rod attached to the upper pendulum records on smoked glass through a multiplying lever, usually multiplying four times. The glass does not move and there is no arrangement for recording the time. The record of movement is superposed upon itself and is usually difficult to interpret. Several of these instruments were working at the time of the California earthquake, and their diagrams are reproduced in Seismograms, Sheet No. 3.

Lately, Professor Wiechert has greatly improved the inverted pendulum.² He has made it very heavy, 1000 kg. or more, in order that he might magnify the motion several hundred times and still not have the movement too much affected by the solid friction of the indicator. He has added a strong viscous friction so as to damp out the proper period of the pendulum and has thus produced a very efficient instrument.

To keep the pendulum in stable equilibrium, springs are attached to a point of the pendulum distant l_4 from its point of support. The forces thus introduced are proportional to the displacement; let us represent these forces brought into play by positive angular displacements, θ_1 and θ_2 , around the axes (1) and (2) respectively, by $v_1 l_4 \theta_1$ and $-v_2 l_4 \theta_2$; v_1 and v_2 would in general have about the same values.

The equations of linear accelerations become

$$M \frac{d^2x}{dt^2} = F_x + f_x - v_2 l_4 \theta_2 \quad M \frac{d^2y}{dt^2} = F_y + f_y + v_1 l_4 \theta_1 \quad M \frac{d^2z}{dt^2} = F_z - Mg \quad (121)$$

The moments become

$$A = F_2 l - f_2 (l_1 - l) - v_1 l_4 \theta_1 (l_4 - l) \quad B = -F_1 l + f_1 (l_1 - l) - v_2 l_4 \theta_2 (l_4 - l) \quad (122)$$

The cosines of the angles between the moving and fixed axes are the same as for the vertical pendulum, equations (108) and (109). The values of the coördinates of the *CG* (x, y, z) are also the same as those given in equation (110), with the sign of l reversed. Carrying thru the same operations as before, making the original position of the *CG* the origin of coördinates and omitting the negligible terms, we arrive at the equations

$$\left. \begin{aligned} I_{(1)} \frac{d^2\theta_1}{dt^2} &= Ml \left\{ \frac{d^2\eta}{dt^2} + g\omega_x - \left(\frac{v_1 l_4^2}{Ml} - g \right) \theta_1 \right\} - f_2 l_1 \\ I_{(2)} \frac{d^2\theta_2}{dt^2} &= -Ml \left\{ \frac{d^2\xi}{dt^2} - g\omega_y + \left(\frac{v_2 l_4^2}{Ml} - g \right) \theta_2 \right\} + f_1 l_1 \end{aligned} \right\} \quad (123)$$

If there is no disturbance $d^2\eta/dt^2$, $d^2\xi/dt^2$, ω_x and ω_y are all zero, and in order that the equilibrium should be stable, we must have $v_1 l_4^2/Ml > g$, and $v_2 l_4^2/Ml > g$. Introducing the values of f_1 and f_2 from equations (119), dividing by $[I_{(1)}]$, $[I_{(2)}]$, and writing $[I_{(1)}]/Ml = L_1$, $[I_{(2)}]/Ml = L_2$, we find

$$\frac{d^2\theta_1}{dt^2} - \frac{1}{L_1} \frac{d^2\eta}{dt^2} + \frac{g\omega_x}{L_1} - \left(\frac{v_1 l_4^2}{Ml} - g \right) \frac{\theta_1}{L_1} = 0 \quad \frac{d^2\theta_2}{dt^2} + \frac{1}{L_2} \frac{d^2\xi}{dt^2} - \frac{g\omega_y}{L_2} + \left(\frac{v_2 l_4^2}{Ml} - g \right) \frac{\theta_2}{L_2} = 0 \quad (124)$$

After adding damping and frictional terms to these equations, they differ from equation (25) only in some of the signs (which is a matter of notation), and in the factor multiplying the angular displacement. If we replace $(v_1 l_4^2/Ml - g)/g$ of equations (124) by i they become equivalent to equation (25), and on passing to the marking points, we get equations equivalent to (26). Therefore all the characteristics of the horizontal pendulum and the interpretation of its record may be applied to the inverted pendulum if we suppose i in the former to be replaced by $(v_1 l_4^2/Ml - g)/g$.

¹ Transactions Seismological Society of Japan, 1882, vol. V, p. 89; and 1883, vol. VI, p. 19.

² Ein astatische Pendel hoher Empfindlichkeit zur mechanischen Registrierung von Erdbeben. E. Wiechert, Gerland's Beiträge zur Geophysik, 1904, vol. VI, pp. 435-450.

SEISMOGRAPHS FOR VERTICAL MOVEMENTS.

The older Italian form of instrument for showing vertical movements was simply a weight hung by a spiral spring, which would be set in motion by any vertical movement of the earth. Palmieri arranged it so that a very small displacement was sufficient to close an electric circuit and thus record a disturbance. Cavalleri added a magnifying lever, which measured the movement of the weight. However, the period of such an instrument would be short unless the spring were inordinately long, and a second form has been devised to obtain a larger period in a smaller compass. This consists of a horizontal bar, pivoted at one end and carrying a weight at the other; it is supported by a spring attached to an intermediate point of the bar. This form of instrument was devised by Thomas Gray.¹ Professor Ewing² suggested that the point of support of the spring be below the bar, thus increasing the period for a given strength of spring.

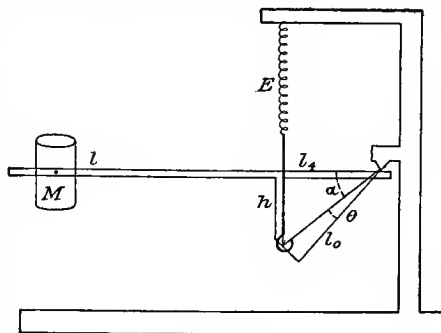

FIG. 59.

Let E be the force of the spring when the pendulum is at rest; and let ρ be the variation of this force for a unit stretch of the spring; then for equilibrium (see figure 59),

$$El_4 - Mgl = 0 \quad \text{or} \quad El_0 \cos \alpha - Mgl = 0 \quad (125)$$

and when the pendulum is displaced thru an angle θ the additional moment will be

$$\frac{d}{d\alpha} (El_0 \cos \alpha) \theta = l_4 \frac{dE}{dh} \frac{dh}{d\alpha} \theta - El_0 \sin \alpha \cdot \theta = (\rho l_4^2 - Eh) \theta \quad (126)$$

and the free period of vibration will be

$$T_0 = 2\pi \sqrt{[I]/(\rho l_4^2 - Eh)} = 2\pi \sqrt{[I]l_4/(\rho l_4^3 - Mglh)} \quad (127)$$

We can therefore make the period as long as we choose by selecting suitable values of ρ , l_4 , M , l , and h .

The next modification for increasing the period of the pendulum is described by Prof. John Milne.³ The supporting spring is a curved flat steel band; and the compensation is obtained by a special spring fastened immediately above the pivot to an arm connected rigidly with the bar of the pendulum. As long as the pendulum is at rest this spring has no effect, but when the bar is raised or lowered, the spring exerts a moment tending to increase the displacement; this is equivalent to reducing the force of restitution due to the main supporting spring, and therefore increases the period of the pendulum. The principle here made use of seems to have been first suggested by Professor Ewing.⁴ Let

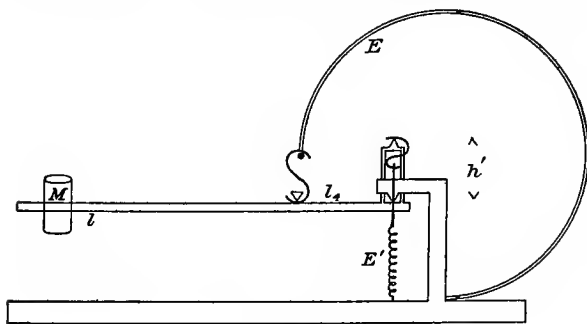

FIG. 60.

¹ On a Seismograph for Registering Vertical Motion, Trans. Seism. Soc. Japan, 1881, vol. iii, p. 137. A similar form is reported to have been used at Comrie, Scotland, in 1841.

² A Seismometer for Vertical Motion. Same, p. 140.

³ The Gray-Milne Seismograph, etc. Same, 1888, vol. xii, pp. 33-48.

⁴ Same, 1881, vol. iii, p. 147.

E' be the force of the compensating spring and let h' be the length of the arm measured from the knife-edge. When the pendulum is displaced thru an angle θ , the moment of the forces of restitution becomes

$$-\frac{l_4 dE}{d\alpha} \theta - E'h' \cdot \theta = (\rho l_4^2 - E'h') \theta \quad (128)$$

and the period of free vibration is

$$T_0 = 2\pi \sqrt{[I]/(\rho l_4^2 - E'h')} \quad (129)$$

If the pendulum points in the positive direction of y , it only records relative deflections around the axis (1). To find the equation of motion of these instruments when subjected to a disturbance, we proceed as in the former cases. For the last-described instrument, using the same notation as heretofore, we find the equation of linear displacement of the CG ,

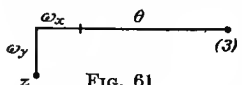

The diagram shows a coordinate system with axes x, y, and z. The z-axis is vertical, the y-axis is horizontal to the left, and the x-axis is horizontal to the right. A pendulum arm is shown along the x-axis, making an angle θ with the z-axis. A point on the arm is labeled (3). The angular displacement of the arm is denoted as ω_x .

FIG. 61.

$$M \frac{d^2x}{dt^2} = F_x \quad M \frac{d^2y}{dt^2} = F_y + f_y - (E - \rho l_4 \theta) \omega_x \quad M \frac{d^2z}{dt^2} = F_z + f_z - Mg + (E - \rho l_4 \theta) - E' \quad (130)$$

The cosines of the angles between the fixed axes and axis (3) are (figure 61)

$$\cos(x, 3) = -\omega_y \quad \cos(y, 3) = -(\omega_x + \theta) \quad \cos(z, 3) = 1 \quad (131)$$

and the general equation of angular acceleration around axis (1) becomes

$$\begin{aligned} \frac{d^2\theta}{dt^2} = \frac{1}{L} \left\{ \left(\frac{d^2\xi}{dt^2} + Z \frac{d^2\omega_y}{dt^2} - (Y+l) \frac{d^2\omega_z}{dt^2} \right) \omega_y + \left(\frac{d^2\eta}{dt^2} + X \frac{d^2\omega_z}{dt^2} - Z \frac{d^2\omega_x}{dt^2} - \frac{f_y}{M} \right) (\omega_x + \theta) \right. \\ \left. - \left(\frac{d^2\xi}{dt^2} + (Y+l) \frac{d^2\omega_x}{dt^2} - X \frac{d^2\omega_y}{dt^2} \right) \right\} - \frac{(\rho l_4^2 - E'h') \theta}{[I]} - \frac{I_1}{[I]} \frac{d^2\omega_1}{dt^2} \end{aligned} \quad (132)$$

The weight Mg has been eliminated through equation (125). If we make the CG_0 the origin of coördinates, omit the negligible terms, and add terms for viscous damping and solid friction, the equation becomes

$$\frac{d^2\theta}{dt^2} + 2\kappa \frac{d\theta}{dt} + \frac{\rho l_4^2 - E'h'}{[I]} \theta + \frac{1}{L} \frac{d^2\xi}{dt^2} \pm p_0 = 0 \quad (133)$$

If we had used the Ewing form of attaching the spring to a point below the bar we should have obtained a similar equation with E and h substituted for E' and h' . The indicator equation becomes, writing n^2 for $(2\pi/T_0)^2$, or $(\rho l_4^2 - E'h')/[I]$,

$$\frac{d^2c}{dt^2} + 2\kappa \frac{dc}{dt} + n^2 c - \frac{\bar{n}l}{L} \frac{d^2\xi}{dt^2} \mp p' = 0 \quad (134)$$

where c is the recorded displacement of the marking point. These 2 equations are entirely similar to equations (25) and (26) for the horizontal pendulum, except that they do not contain a rotation. The physical explanation of this is that the position of equilibrium of the horizontal pendulum *relative to the support* is altered by the rotation ω_y , but that of the vertical motion pendulum is practically unaffected by a small rotation about any axis. If we place our origin at the CG_0 , the only term in the general equation (132), containing the angular acceleration about (1), is $(I_1/[I]) d^2\omega_1/dt^2$, which corresponds to the term we considered on page 158 for the horizontal pendulum. The factor $I_1/[I]$ will in general be small; for a beam carrying a brass sphere 10 cm. in diameter, at a distance of 40 cm. from the axis of rotation, it would not be as much as $\frac{1}{160}$; and since $d^2\omega_1/dt^2$ is, in general, much less than $d^2\theta/dt^2$, the motion of these instruments is only affected to an entirely negligible extent by a rotation around the CG_0 .

The form of instrument in most general use for recording vertical motion is that developed by Professor Vicentini of Padua,¹ though the principle seems to have been used in Comrie, Scotland, in 1841.² It consists of a heavy mass supported by an elastic rod so that it vibrates in a vertical plane, and records by means of multiplying levers on smoked paper. Usually there is no damping. The complete theory of this instrument is that of a weighted elastic rod, and is very complicated. It has several proper periods of vibration, and it would be set in vertical motion by a horizontal displacement in the direction in which it points. We can, however, develop an approximate theory which

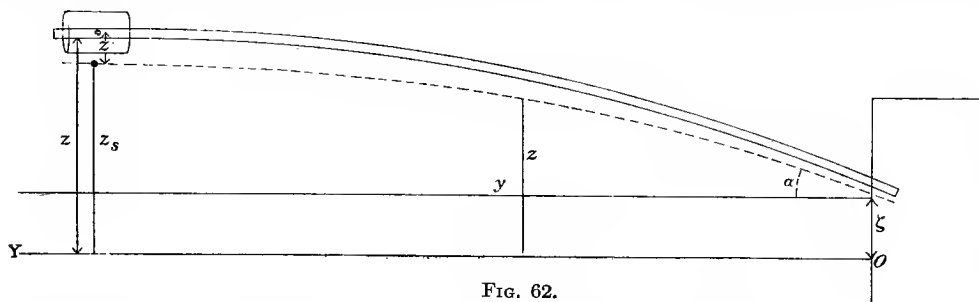

FIG. 62.

is quite simple. Let the instrument point in the positive direction of y and let z be positive upwards; see figure 62. Take the origin O , at a distance ζ below the point where the rod is supported. Later, ζ will be considered the vertical displacement of the support. Let l be the length of the rod, J the so-called moment of inertia of its cross-section, which we consider constant; E Young's modulus for the material of the rod, M the mass at its end, and M' an arbitrary mass. If we consider the bar but slightly bent, its curvature will be represented by d^2z/dy^2 ; and we have from the general theory of a loaded cantilever, neglecting the weight of the rod,

$$EJd^2z/dy^2 = -M'g(l-y) \quad (135)$$

Integrate this equation twice, and determine the constants of integration by the conditions that $dz/dy = \alpha$, and $z = \zeta$, when $y = 0$; we get the equation

$$6EJ(z - \zeta - \alpha y) = -M'g(3ly^2 - y^3) \quad (136)$$

where z refers to the point on the bar whose abscissa is y . For the CG of M' , $y = l$, and letting z now represent the ordinate of this point, we get

$$6EJ(z - \zeta - \alpha l) = 2M'gl^3 \quad (137)$$

which gives us the ordinate of the CG when it is at rest, the mass being supported by the slightly bent rod.

To determine the acceleration when the weight is not at rest, we may replace M' by $M + M_1$; and by d'Alembert's principle, equation (137) will still hold when we replace M_1g by the force $[M]d^2z/dt^2$, where d^2z/dt^2 is the acceleration of the CG and where $[M] = M + (I' + n_2^2I'' + \dots)/l_2^2$ is the effective mass of M and the multiplying levers; this is analogous to the value of $[I]$ determined on page 155 and can be found in the same way by the consideration of the reactions of the multiplying levers. On making these substitutions we get for the equation of the moving CG in absolute coördinates

$$6EJ(z - \zeta - \alpha l) = -2Mgl^3 - 2[M]l^3 \frac{d^2z}{dt^2} \quad (137a)$$

¹ *Microsismographo per la componente verticale*, G. Vicentini e G. Pacher. *Boll. Soc. Sismologica Italiana*, 1899-1900, vol. V, pp. 33-58.

² *British Assoc. Report*, 1842, p. 64.

Writing z_s for the ordinate of the CG_s , when at rest and the mass at the end of the rod is M , we get from (137)

$$6 EJ(z_s - \zeta - al) = -2 Mgl^3$$

The last two equations give by subtraction

$$z - \zeta = z_s - \zeta - \frac{[M]l^3}{3 EJ} \frac{d^2z}{dt^2} \quad (138)$$

z is the absolute ordinate of the CG , z_s of the CG_s ; and $z_s - \zeta$ is the ordinate of the CG_s relative to the support. If the support vibrates under the action of earthquake waves, ζ will vary. In order to express the displacement in terms of the motion of the CG relative to the CG_s , we must move our origin to z_s , l , and call the displacement of the CG from this point z' ; that is, we substitute $z - z_s = z'$, and since $z_s - \zeta$ is constant when ζ is varying under the vertical movement of the support, $d^2z_s/dt^2 = d^2\zeta/dt^2$; we get

$$z' = - \frac{[M]l^3}{3 EJ} \left(\frac{d^2z'}{dt^2} + \frac{d^2\zeta}{dt^2} \right) \quad (139)$$

Introducing damping and frictional terms, and putting $3 EJ/[M]l^3 = (2\pi/T_0)^2 = n^2$, this may be written

$$\frac{d^2z'}{dt^2} + 2\kappa \frac{dz'}{dt} + n^2z' + \frac{d^2\zeta}{dt^2} \pm p_0 = 0 \quad (140)$$

For the equation of the marking point we multiply by $\bar{m} = m_1m_2 \dots$; and since c , the displacement of the marking point equals $\bar{m}z'$, we get

$$\frac{d^2c}{dt^2} + 2\kappa \frac{dc}{dt} + n^2c - \bar{m} \frac{d^2\zeta}{dt^2} \mp p' = 0 \quad (141)$$

which is entirely similar to the equations of the other forms of vertical motion instruments.

As we have only considered linear displacements, the position of the origin of coördinates is unimportant; but if a rotation occurs, it must be considered. A rotation around the CG_0 as origin would evidently have no effect, if we neglect the moment of inertia of the mass about its CG , as we have done. But an angular acceleration $d^2\omega_x/dt^2$ around an axis through O at right angles to the paper would make $z_s - \zeta - \omega_x l$ instead of $z_s - \zeta$ constant during the motion and would therefore add a term $ld^2\omega_x/dt^2$ to (140) and $\bar{m}ld\omega_x/dt^2$ to (141). These terms in general would probably be unimportant.

We see thus that the approximate equations of all forms of seismographs referred to the CG_0 are of the same general form; except that no rotation is present in the equations of the vertical motion instruments. The formulas (79a) and (81) are applicable to them all to determine their magnifying powers.

SEPARATION OF LINEAR DISPLACEMENTS AND TILTS.

A rigid body can be moved from one position in a plane to any other by means of a linear displacement and a rotation; altho the direction of the axis of the rotation and the amount of the rotation are determined by the two positions of the body, the distance of the axis is not; we can choose this distance arbitrarily and then determine the linear displacement to correspond; and the total displacement of a point of the body will be the displacement due to the rotation around the axis plus the linear displacement of the axis; as the rotation is independent of the distance of the axis, the nearer the latter is to the body, the greater will be the displacement due to the displacement of the axis and the less will be that due to rotation; and there is one distance of the axis for which all the displacement may be expressed as a rotation. We see therefore the origin of the difficulty

in separating displacements and rotations; for their relative effects in producing movements of the seismograph depend on the arbitrary choice of the axis for the rotation. This appears in equation (16), where the values of the various coefficients depend on the choice of the origin of coördinates, about which the rotations are supposed to take place.

If we could get rid of the effects of linear displacements, we could determine the rotations. This was first done by Professor Milne,¹ who supported a beam by knife-edges at its center of gravity; and later by Dr. Schlüter.² These instruments failed to show any tilts at the times of the earthquakes, which therefore must be extremely small.

A second method of determining tilts has been proposed by Professor Wiechert.³ Let two horizontal pendulums with equal values of κ , $\bar{n}l/L$ and gi/L be installed, one vertically over the other; and let the origin of coördinates be chosen at the CG_0 of the lower pendulum; its equation will be

$$\frac{d^2 a_1}{dt^2} + 2\kappa \frac{da_1}{dt} - \frac{\bar{n}l}{L} \frac{d^2 \xi}{dt^2} + \frac{gi}{L} \left(\frac{\bar{n}l\omega_y}{i} + a_1 \right) \mp p_1' = 0 \quad (25)$$

the equation of the upper pendulum will be

$$\frac{d^2 a_2}{dt^2} + 2\kappa \frac{da_2}{dt} - \frac{\bar{n}l}{L} \frac{d^2 \xi}{dt^2} - \frac{\bar{n}lZ'}{L} \frac{d^2 \omega_y}{dt^2} + \frac{gi}{L} \left(\frac{\bar{n}l\omega_y}{i} + a_2 \right) \mp p_2' = 0 \quad (142)$$

it contains an extra term $-(\bar{n}lZ'/L)d^2\omega_y/dt^2$ where $Z' = Z - il$ is, in this case, the distance between the centers of gravity of the 2 pendulums; the origin of this term will appear on referring to equation (16). On taking the difference of these two equations we get

$$\frac{d^2(a_2 - a_1)}{dt^2} + 2\kappa \frac{d(a_2 - a_1)}{dt} - \frac{\bar{n}lZ'}{L} \frac{d^2 \omega_y}{dt^2} + \frac{gi}{L} (a_2 - a_1) \mp (p_2' - p_1') = 0 \quad (143)$$

which gives us a relation between the record and the angular acceleration of the earth about the axis of y without containing the linear displacement. If we work out the value of ω_y and substitute it in equation (25) we can then find the linear acceleration. Prince Galitzin has shown a very elegant manner of carrying out this process by the use of his method of electromagnetic recording thru a galvanometer.⁴ Professor Wiechert's method presupposes that the supports of the 2 pendulums move as tho they were parts of a rigid body, and therefore that the motions can be represented as the same rotation about the same axis. This would certainly not be the case if the upper instrument were mounted in a high building, for then the vibrations of the building would interfere; and it may be questioned whether the condition would hold for two points at different distances below the surface of the earth. But if two pendulums are mounted, one above the other on the same support, as Prince Galitzin arranged them in his experiments, these objections disappear.

A similar method can be applied to vertical motion instruments; let us suppose that two similar instruments are mounted close together with their axes of rotation in the same straight line, but with their beams pointing in opposite directions; it is evident that any vertical displacement would affect them alike, but a rotation around their common axis of rotation would cause movements in opposite directions. The equations of the two

¹ British Assoc. Reports, 1892.

² Schwingungsart und Weg der Erdbebenwellen. Gerland's Beiträge zur Geophysik, 1903, vol. V, pp. 314-359, 401-465.

³ Principien für die Beurtheilung der Wirksamkeit von Seismographen. Verhand. 1^{ste} Intern. Seismol. Konferenz. Gerland's Beiträge zur Geophysik, Ergänzungsband I, pp. 264-280.

⁴ Ueber die Methode zur Beobachtung von Neigungswellen. Acad. Imp. des Sciences St. Petersburg. C. R. Com. Perm. Sismique, 1905, T. II, Liv. II, pp. 1-144.

instruments would be, on putting the origin of coördinates at the axis of rotation (see equations (132) and (134)),

$$\text{and } \left. \begin{aligned} \frac{d^2c_1}{dt^2} + 2\kappa \frac{dc_1}{dt} + n^2c_1 - \frac{\bar{n}l}{L} \frac{d^2\xi}{dt^2} - \frac{\bar{n}l}{L} \frac{d^2\omega_x}{dt^2} \mp p_1' &= 0 \\ \frac{d^2c_2}{dt^2} + 2\kappa \frac{dc_2}{dt} + n^2c_2 - \frac{\bar{n}l}{L} \frac{d^2\xi}{dt^2} + \frac{\bar{n}l}{L} \frac{d^2\omega_x}{dt^2} \mp p_2' &= 0 \end{aligned} \right\} \quad (144)$$

on adding these two equations, the tilt disappears; and on subtracting one from the other, the vertical linear displacement disappears. The two instruments record the displacement and rotation of the same point, and therefore the separation of these two involves no supposition as to the motions of points at some distance apart.

Prince Galitzin has described another method of measuring comparatively rapid tilts. He has shown that a bar hung by wires of equal length, attached to its ends, the wires themselves being fastened to the support at different heights, so that the bar hangs in an inclined position, will be rotated around a vertical plane by a tilt at right angles to the plane of the wires, and this rotation will not be affected by the swinging of the bar as a pendulum. This is a modification of the bifilar pendulum, designed by Mr. Horace Darwin for the study of slow earth-tilts.¹

¹ See C. Davison, Bifilar Pendulum for Measuring Earth-Tilts. *Nature*, 1894, vol. L, pp. 246-249.

DEFINITIONS.

ξ, η, ζ ,	linear displacements of the ground.	M ,	mass of the pendulum.
ω ,	rotation of the ground.	l ,	distance of CG from the axis of rotation.
P ,	period of linear displacements of the ground.	$L = [I]/Ml$,	distance of center of oscillation from axis of rotation.
Q ,	period of rotations of the ground.	i ,	inclination of axis of rotation to the vertical.
$p = 2\pi/P$.		$L' = L/i$,	length of simple mathematical pendulum having the same period.
T ,	period of the pendulum with damping.	κ ,	coefficient of viscous damping.
T_0 ,	period of the pendulum without damping.	$1/\kappa$,	relaxation time, that is, the time required for the amplitude to diminish in the proportion $1 : 1/e$.
T_v ,	period of the pendulum without damping when swung vertically.	ϵ ,	damping ratio.
CG ,	center of gravity of the pendulum at any time.	Δ ,	logarithmic decrement.
CG_0 ,	center of gravity of the pendulum when at rest.	r ,	frictional displacement of medial line.
$CG_{..}$,	center of gravity of the pendulum supposed rigidly connected with the support and moving with it.	a ,	amplitude of the recording point.
I_1 ,	moment of inertia of the pendulum about CG .	A ,	range of the recording point.
$I_{(1)}$,	moment of inertia of the pendulum about axis of rotation.	V ,	magnifying power for rapid linear harmonic displacements.
$[I]$,	complete moment of inertia about axis of rotation, including the magnifying levers.	W ,	magnifying power for linear harmonic displacements of any period.
		U ,	magnifying power for harmonic rotations of any period.

USEFUL FORMULÆ.

$$i = T_v^2/T_0^2 \quad (34)$$

$$\frac{gi}{L} = \frac{g}{L'} = \left(\frac{2\pi}{T_0}\right)^2 \quad (38)$$

$$T_0 = \frac{T}{\sqrt{1 + (\kappa T/2\pi)^2}} \quad (38 \text{ a})$$

$$T_0 = T \left\{ 1 - \frac{1}{2} (\kappa T/2\pi)^2 \right\} \text{ when } \kappa \text{ is small} \quad (39)$$

$$\left(\frac{\kappa T_0}{2\pi}\right)^2 = \left(\frac{\kappa T}{2\pi}\right)^2 / \left\{ 1 + \left(\frac{\kappa T}{2\pi}\right)^2 \right\} \quad (44 \text{ a})$$

$$\left(\frac{\kappa T_0}{2\pi}\right)^2 = \frac{\log^2 \epsilon}{\pi^2 + \log^2 \epsilon} = \frac{\log^2 \epsilon}{1.862 + \log^2 \epsilon} \quad (44 \text{ b})$$

$$\frac{\kappa T}{2\pi} = \frac{\Delta}{\pi} = \frac{0.733}{n} \log \epsilon^n \quad (44)$$

$$\frac{1}{\kappa} = \frac{T}{2\Delta} \text{ from} \quad (44)$$

$$\epsilon^n = \frac{A_1 - A_{n+1}}{A_{n+1} - A_{2n+1}} \quad (54)$$

$$2r = \frac{A_2^2 - A_1 A_3}{A_1 - A_3} \quad (52)$$

$$2r = \frac{\epsilon - 1}{\epsilon + 1} \frac{A_{n+1}^2 - A_1 A_{2n+1}}{(A_1 - A_{n+1}) - (A_{n+1} - A_{2n+1})} \quad (57)$$

$$\kappa = \frac{4.605}{nT} \log \frac{A_1 - A_{n+1}}{A_{n+1} - A_{2n+1}} \quad (56)$$

$$W = \frac{V}{\sqrt{4 \frac{\log^2 \epsilon}{1.862 + \log^2 \epsilon} \left(\frac{P}{T_0}\right)^2 + \left\{ \left(\frac{P}{T_0}\right)^2 - 1 \right\}^2}} \quad (79 \text{ a})$$

$$W = \frac{V}{\sqrt{4 \left(\frac{\kappa T_0}{2\pi}\right)^2 \left(\frac{P}{T_0}\right)^2 + \left\{ \left(\frac{P}{T_0}\right)^2 - 1 \right\}^2 + 4 \left(\frac{\kappa T_0}{2\pi}\right) \left(\frac{P}{T_0}\right) \left(\frac{4r}{\pi a}\right) \left(\frac{P}{T_0}\right)^2 + \left(\frac{4r}{\pi a}\right)^2 \left(\frac{P}{T_0}\right)^4}} \quad (81)$$

$$U = \frac{\bar{n}}{i} \frac{(Q/T_0)^2}{\sqrt{4 \frac{\log^2 \epsilon}{1.862 + \log^2 \epsilon} \left(\frac{Q}{T_0}\right)^2 + \left\{ \left(\frac{Q}{T_0}\right)^2 - 1 \right\}^2}} \quad (91)$$

$$V = \bar{n}l/L = i\bar{n}l/L' = a_1/L'i\theta \quad (29) \text{ and } (33)$$

where a_1 is the displacement of the pointer corresponding to an angular displacement θ of the pendulum.